

[54] PISTOL TELESCOPE MOUNT

[76] Inventor: Daniel L. Bechtel, P.O. Box 11281, Fort Worth, Tex. 76109

[**] Term: 14 Years

[21] Appl. No.: 303,146

[22] Filed: Sep. 17, 1981

[51] Int. Cl. D22-01

[52] U.S. Cl. D22/7

[58] Field of Search 248/205.1, 226.1, 226.4, 248/226.5; 42/72; D22/1, 7

[56] References Cited

U.S. PATENT DOCUMENTS

D. 255,140 5/1980 Weast D22/7

D. 259,204 5/1981 Weast D22/7
D. 262,481 12/1981 Bechtel D22/7

Primary Examiner—A. Hugo Word
Attorney, Agent, or Firm—Charles W. McHugh

[57] CLAIM

The ornamental design for a pistol telescope mount, as shown.

DESCRIPTION

FIG. 1 is a perspective view of a "pistol telescope mount" showing my new design; FIG. 2 is a top plan view thereof; FIG. 3 is a bottom plan view thereof; FIG. 4 is a front elevational view thereof; FIG. 5 is a rear elevational view thereof; FIG. 6 is a left elevational side view thereof; and FIG. 7 is a right elevational side view thereof.

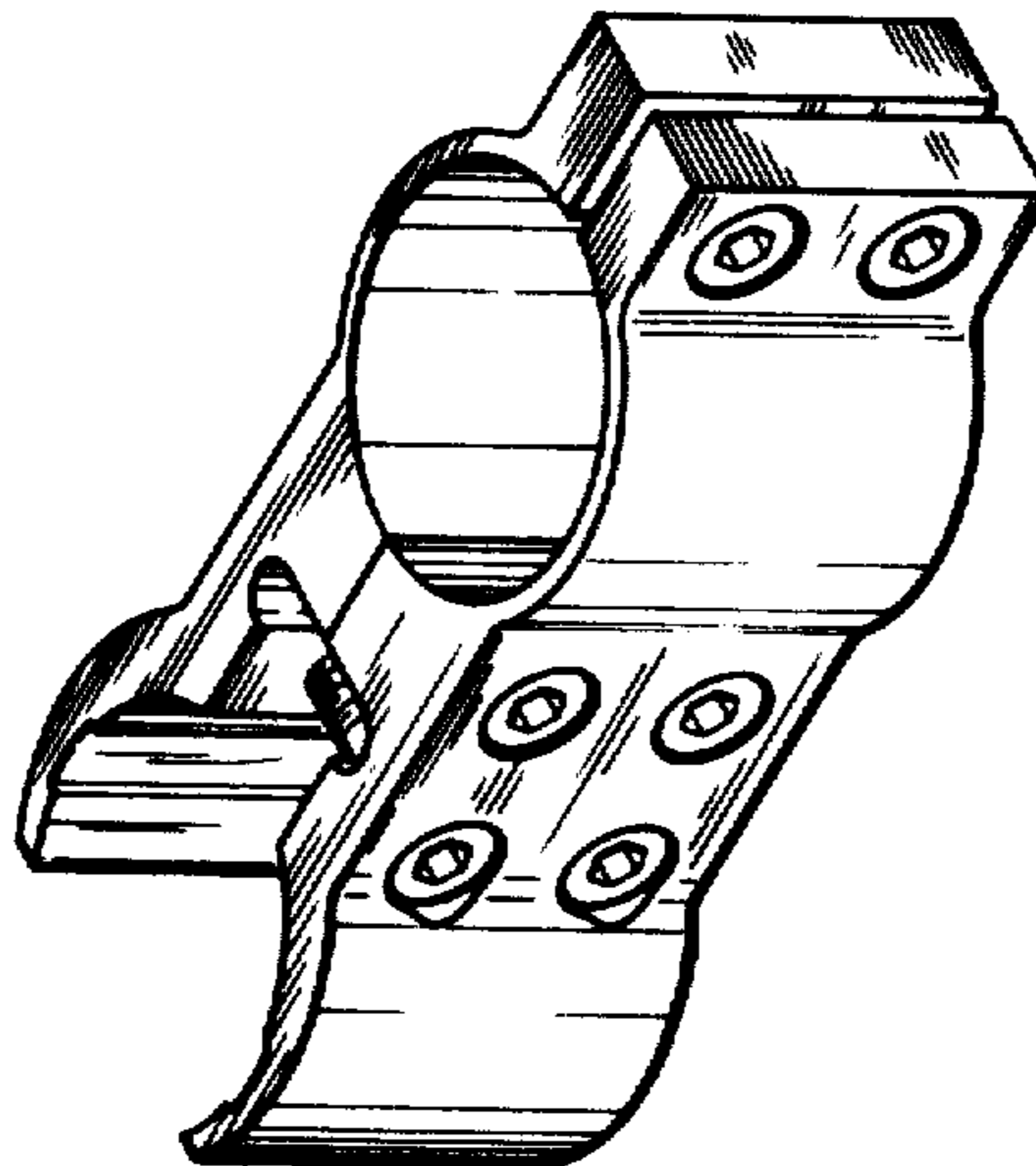

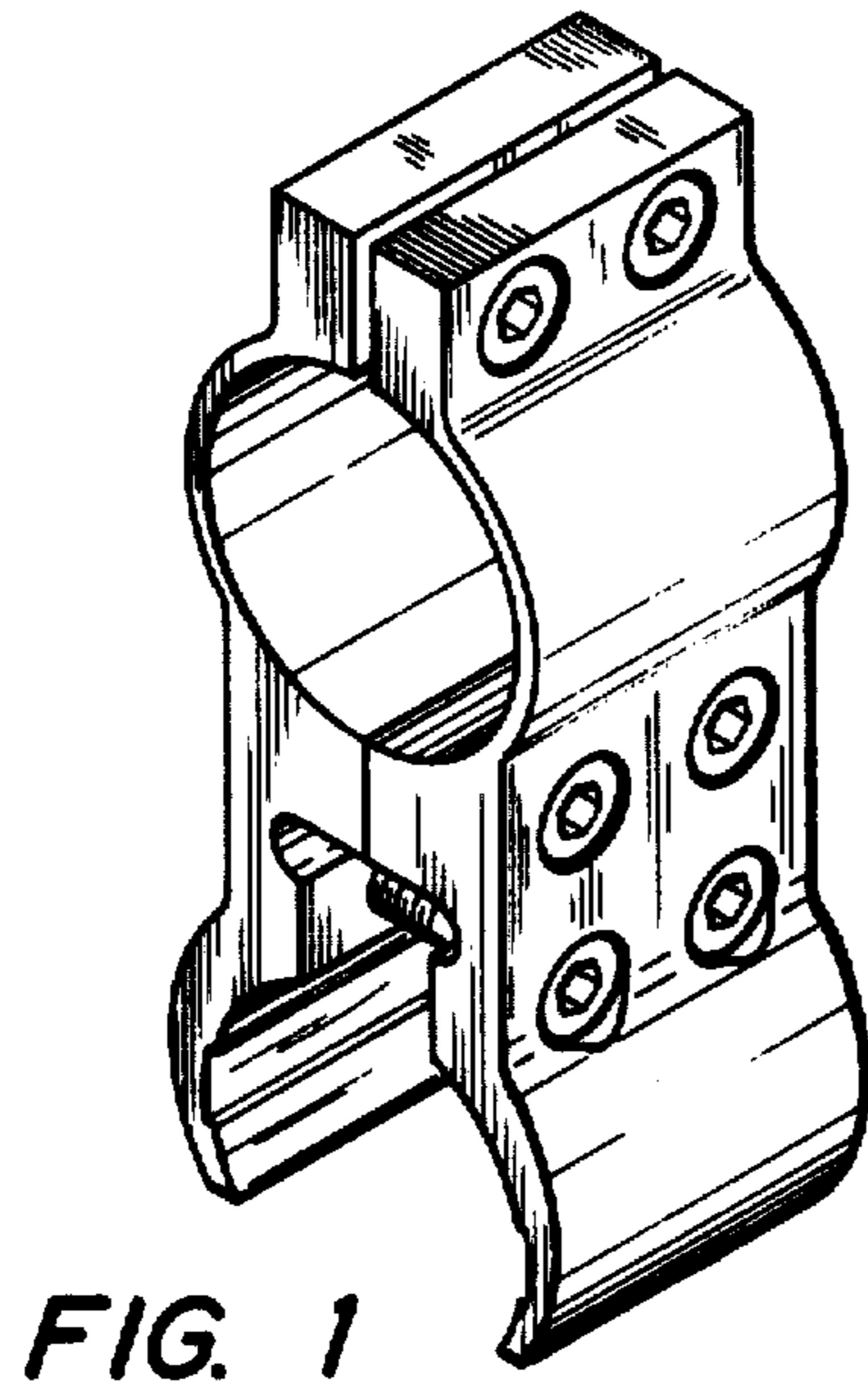

FIG. 2

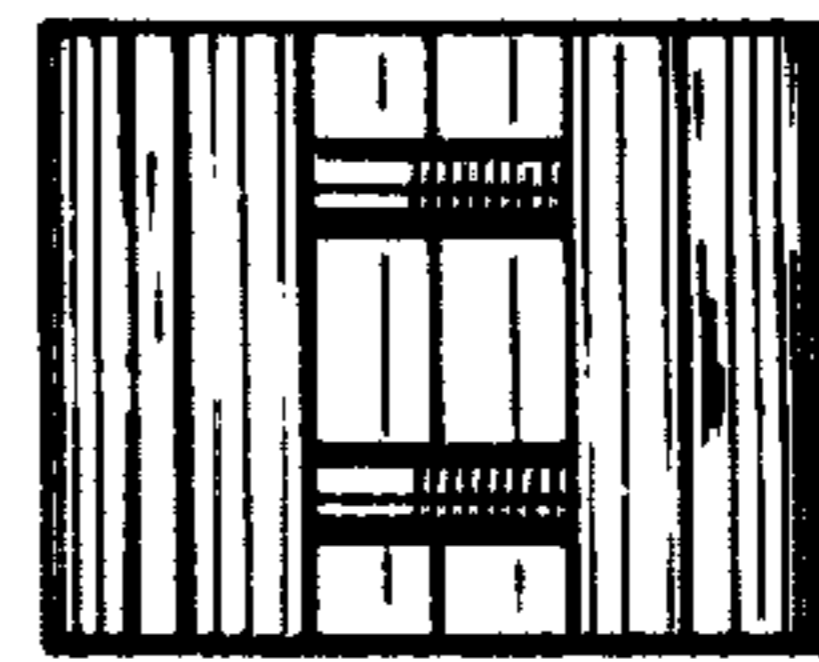

FIG. 3

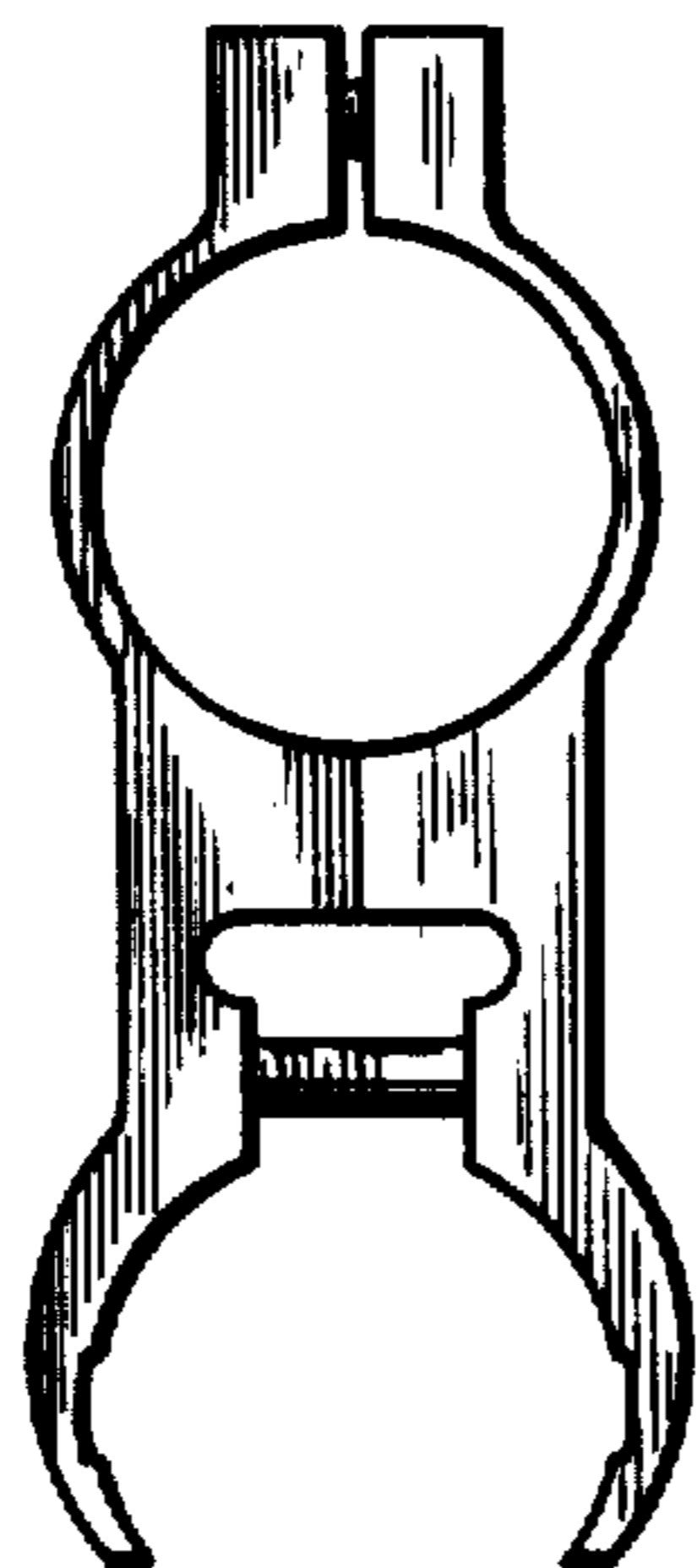

FIG. 4

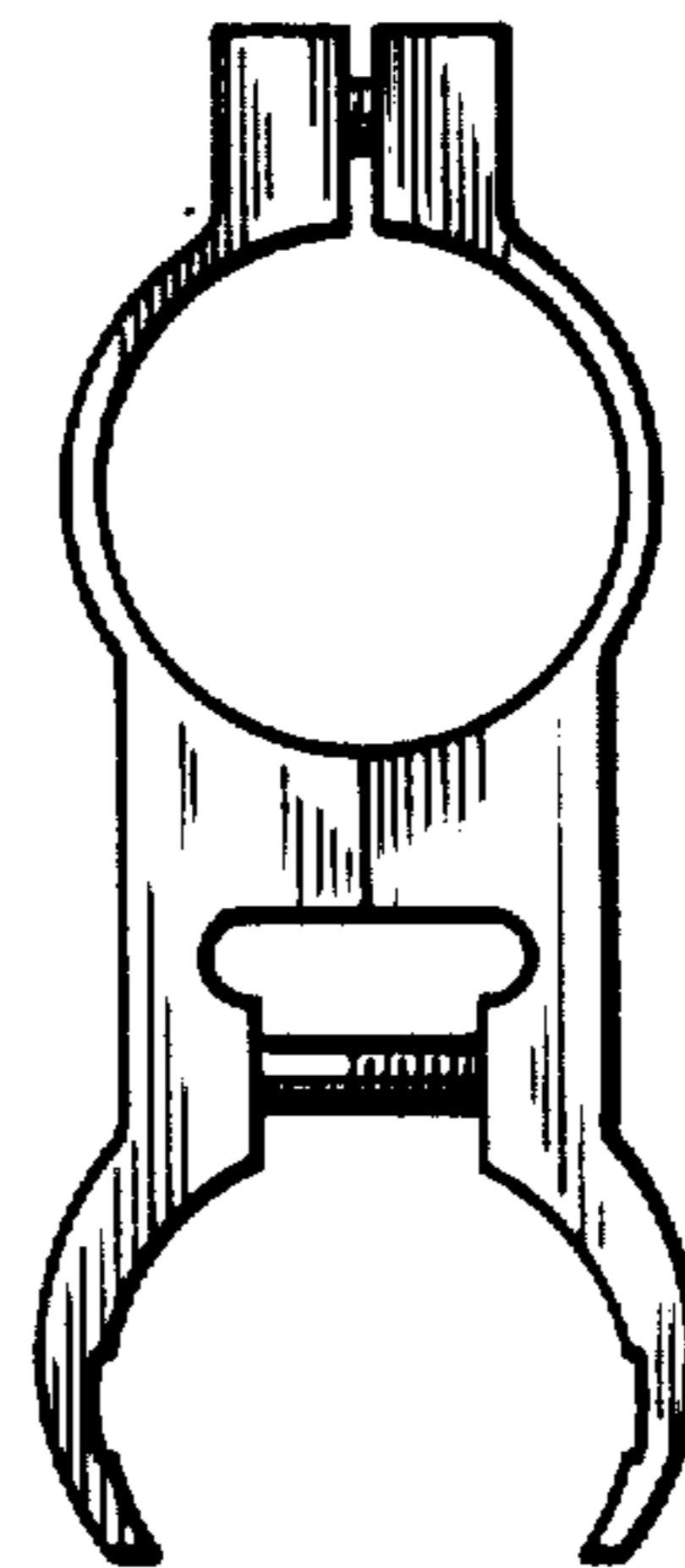

FIG. 5

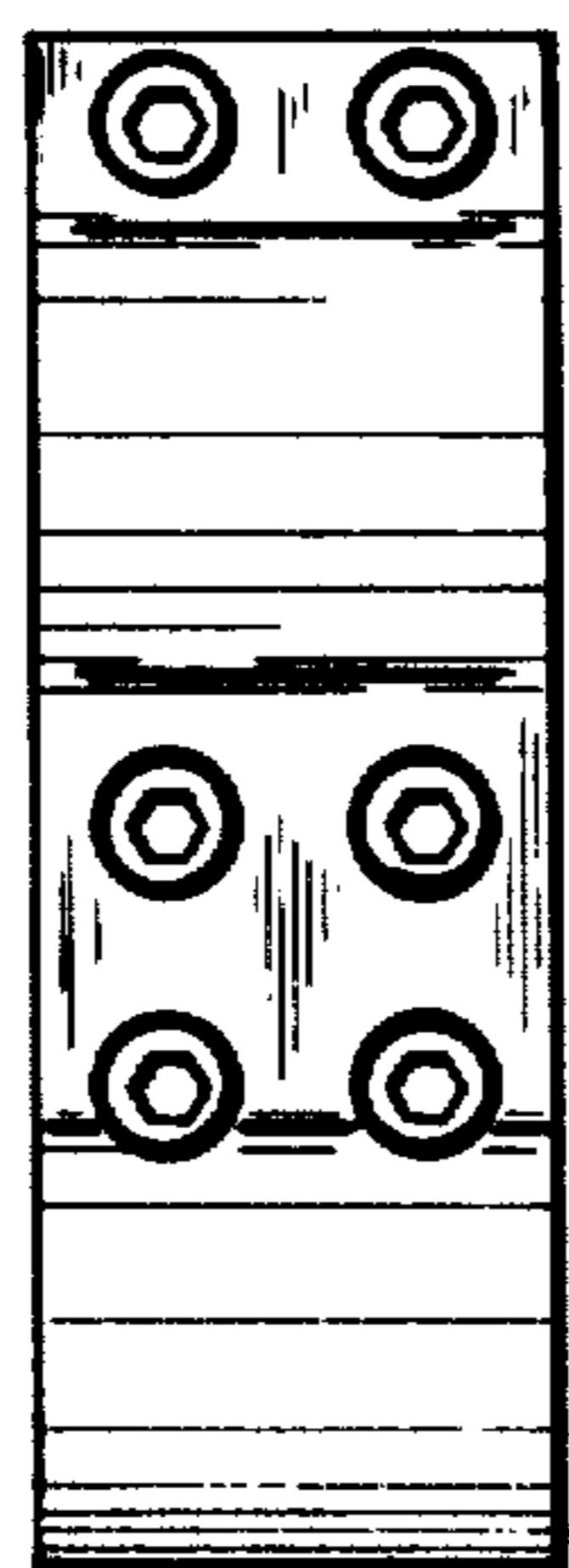

FIG. 6

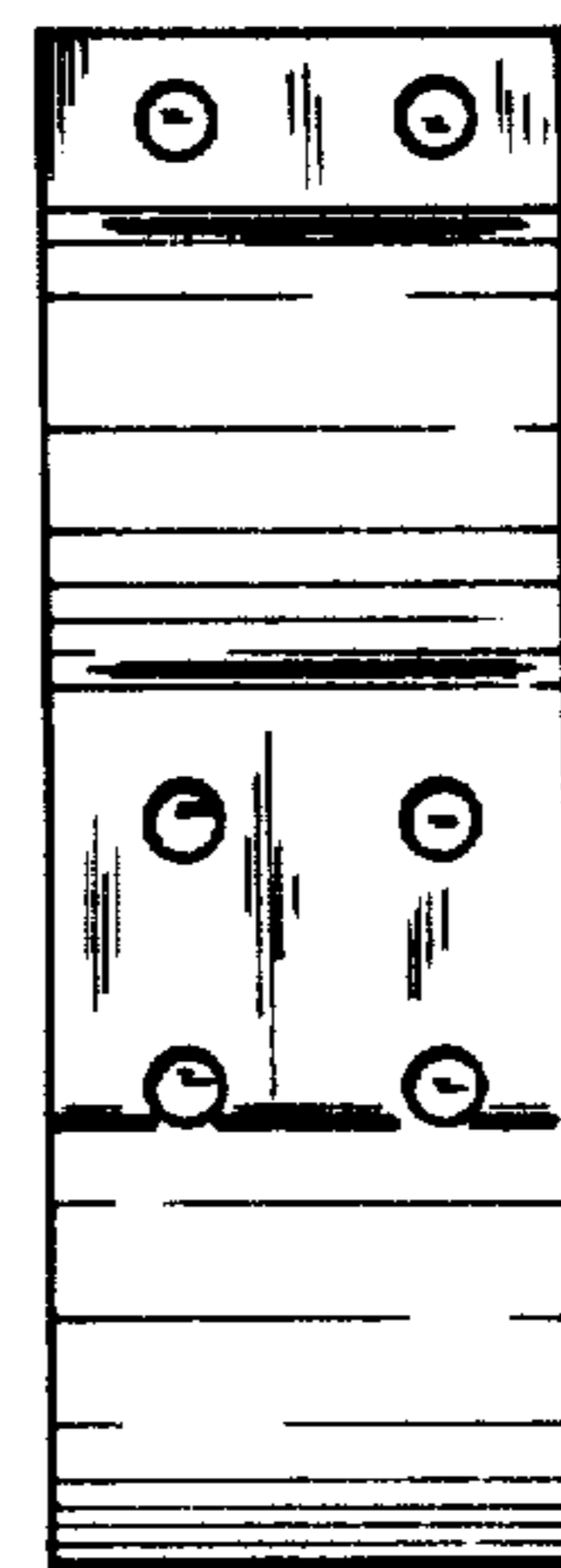

FIG. 7