

[54] AIR COMPRESSOR UNIT

[75] Inventor: William J. Davis, Levittown, Pa.

[73] Assignee: Interdynamics, Inc., Brooklyn, N.Y.

[**] Term: 14 Years

[21] Appl. No.: 414,493

[22] Filed: Sep. 2, 1982

[51] Int. Cl. D15-02

[52] U.S. Cl. D15/9

[58] Field of Search D15/9; 417/234, 63, 417/313

[56] References Cited

U.S. PATENT DOCUMENTS

| | | | | |
|------------|--------|---------|-------|--------|
| D. 174,901 | 6/1955 | Gamble | | D15/9 |
| D. 177,701 | 5/1956 | Sykes | | D15/9 |
| D. 194,722 | 2/1963 | Umholtz | | D15/7 |
| D. 222,846 | 1/1972 | Kondo | | D15/9 |
| D. 243,272 | 2/1977 | Okuno | | D48/24 |
| D. 245,005 | 7/1977 | Carter | | D15/9 |
| 2,733,661 | 2/1956 | Surgi | | 103/23 |

OTHER PUBLICATIONS

Sears Spring/Summer Catalog, 1979, p. 688, Item #3—Miller 12-Volt Air Pump.

Primary Examiner—Wallace R. Burke
Assistant Examiner—Lynn Wilder
Attorney, Agent, or Firm—Henry R. Lerner

[57] CLAIM

The ornamental design for an air compressor unit, substantially as shown.

DESCRIPTION

FIG. 1 is a front perspective view of an air compressor unit wherein my design is embodied in an air compressor and lamp therefor;

FIG. 2 is a top plan view thereof;

FIG. 3 is a rear elevational view thereof;

FIG. 4 is a left side elevational view thereof;

FIG. 5 is a right side elevational view thereof;

FIG. 6 is a bottom plan view thereof;

FIG. 7 is a front perspective view of an air compressor unit wherein my design is embodied in an air compressor;

FIG. 8 is a top plan view thereof;

FIG. 9 is a rear elevational view thereof;

FIG. 10 is a left side elevational view thereof;

FIG. 11 is a right side elevational view thereof; and

FIG. 12 is a bottom plan view thereof.

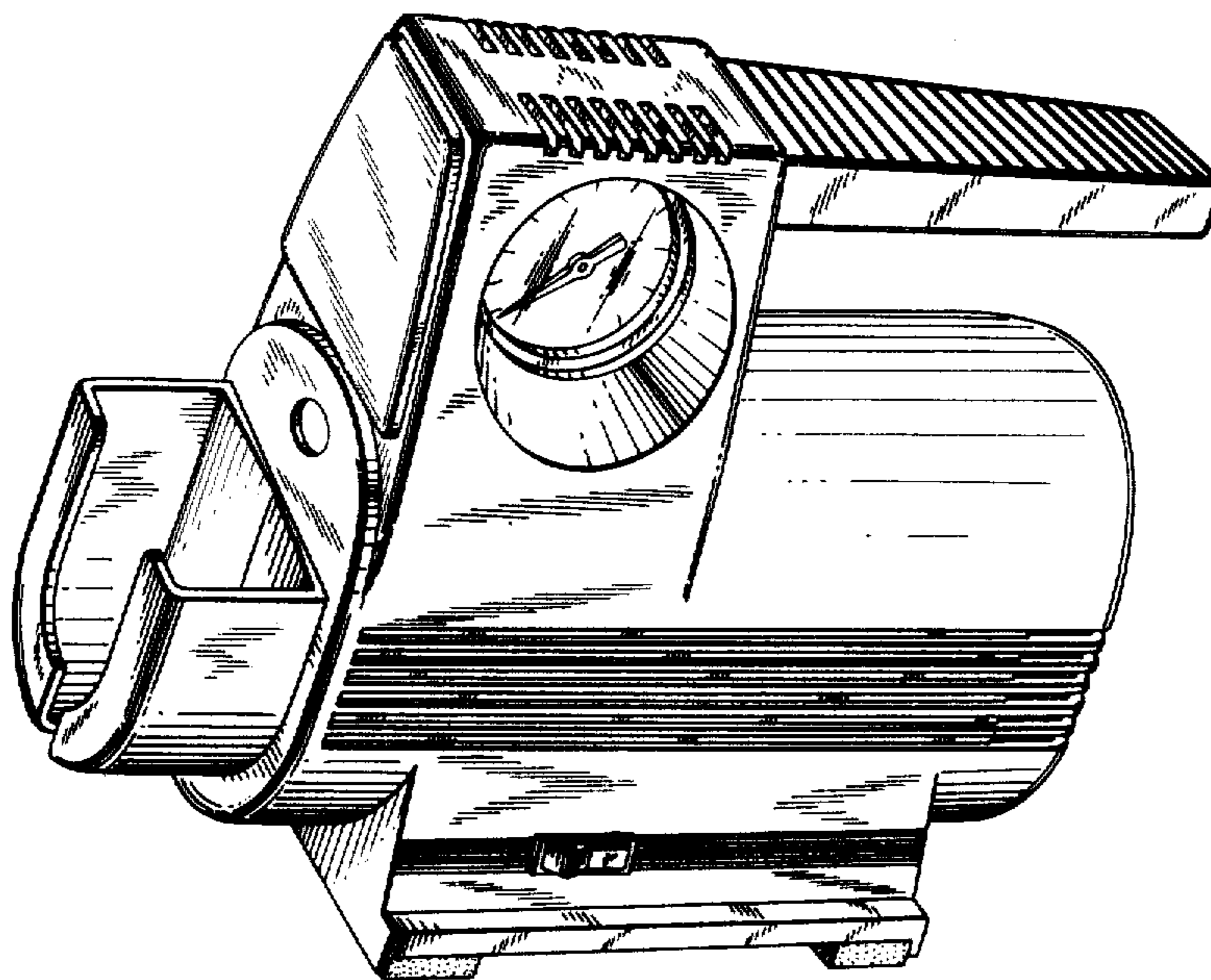

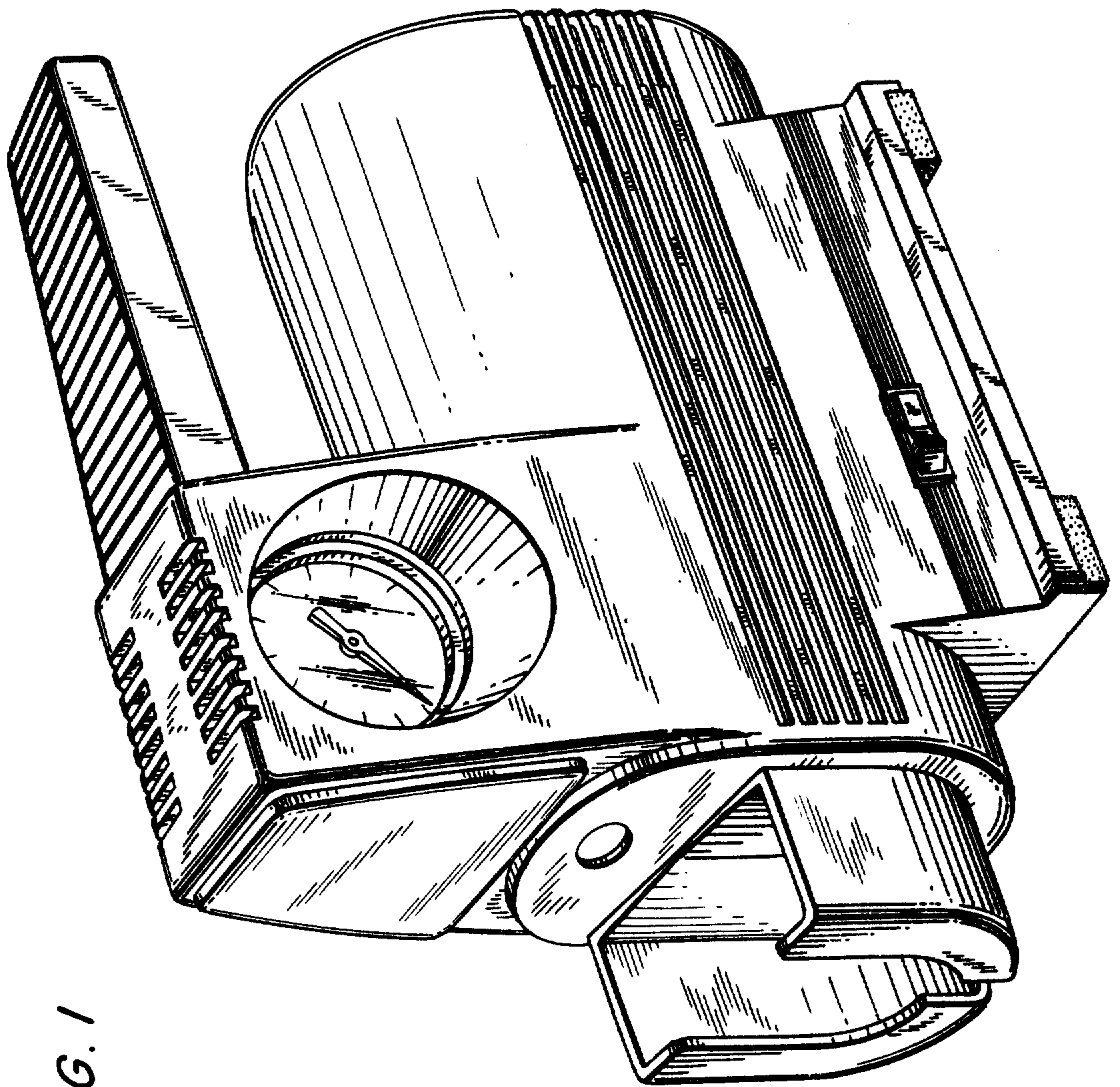

FIG. 1

FIG. 2

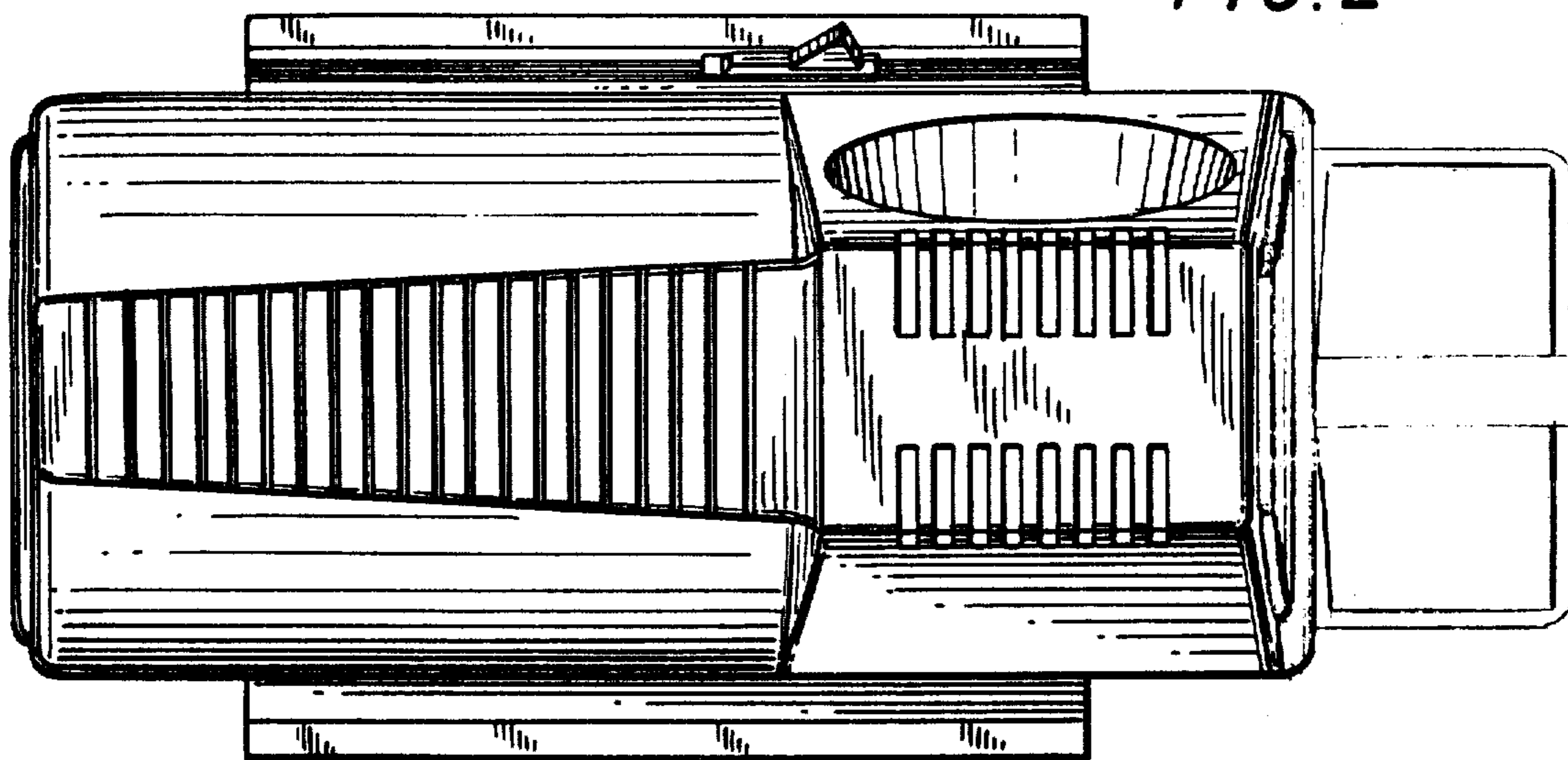

FIG. 3

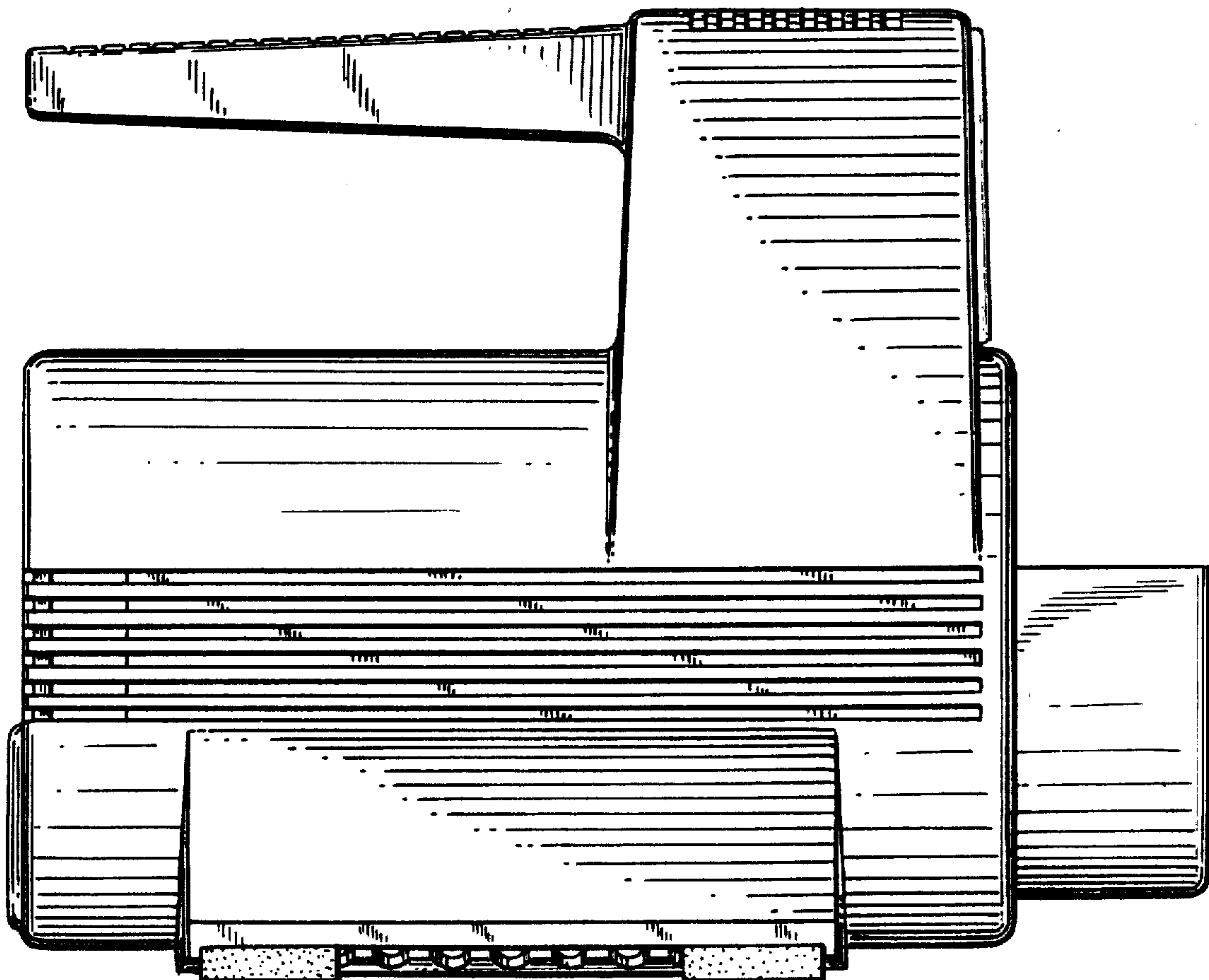

FIG. 4

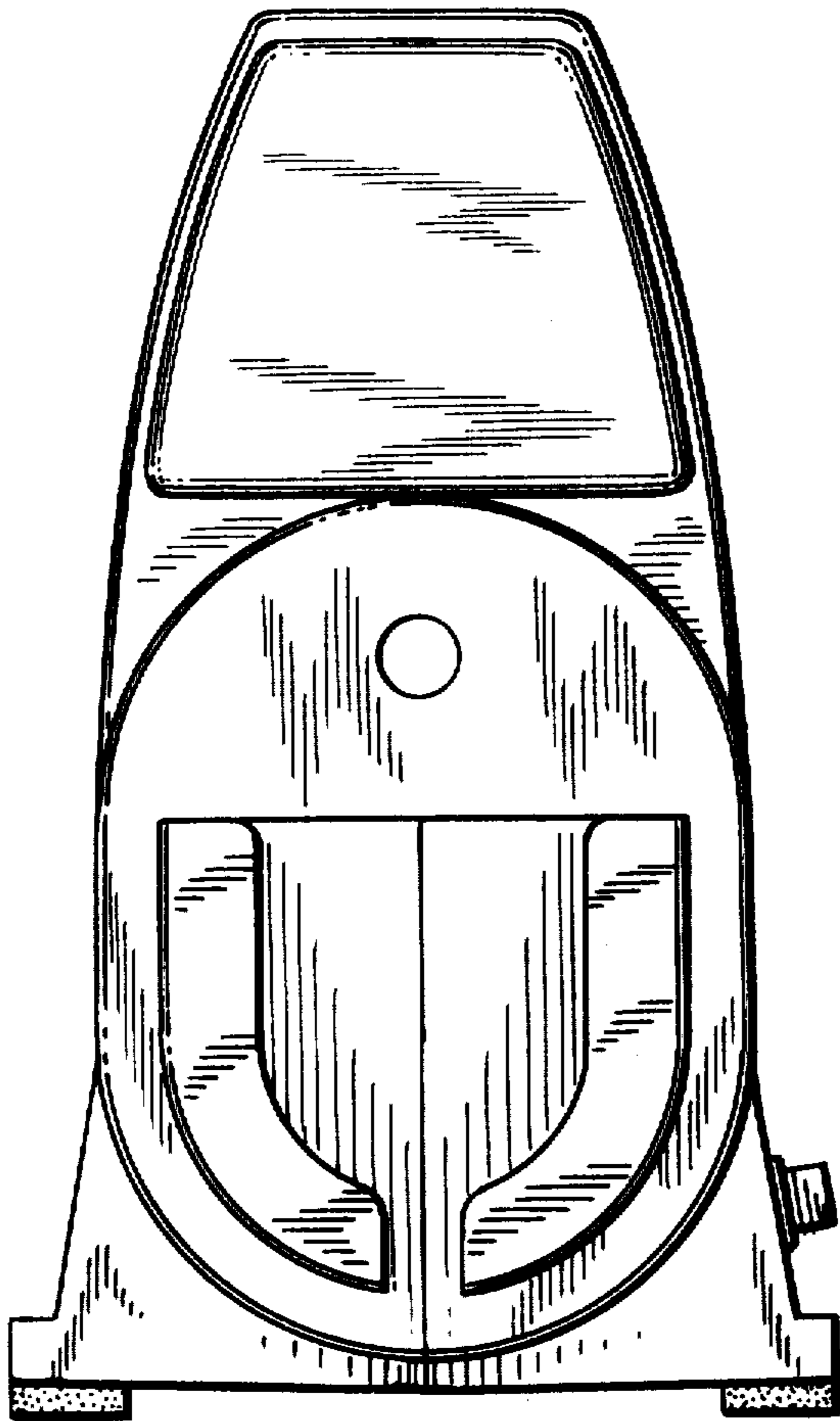

FIG. 5

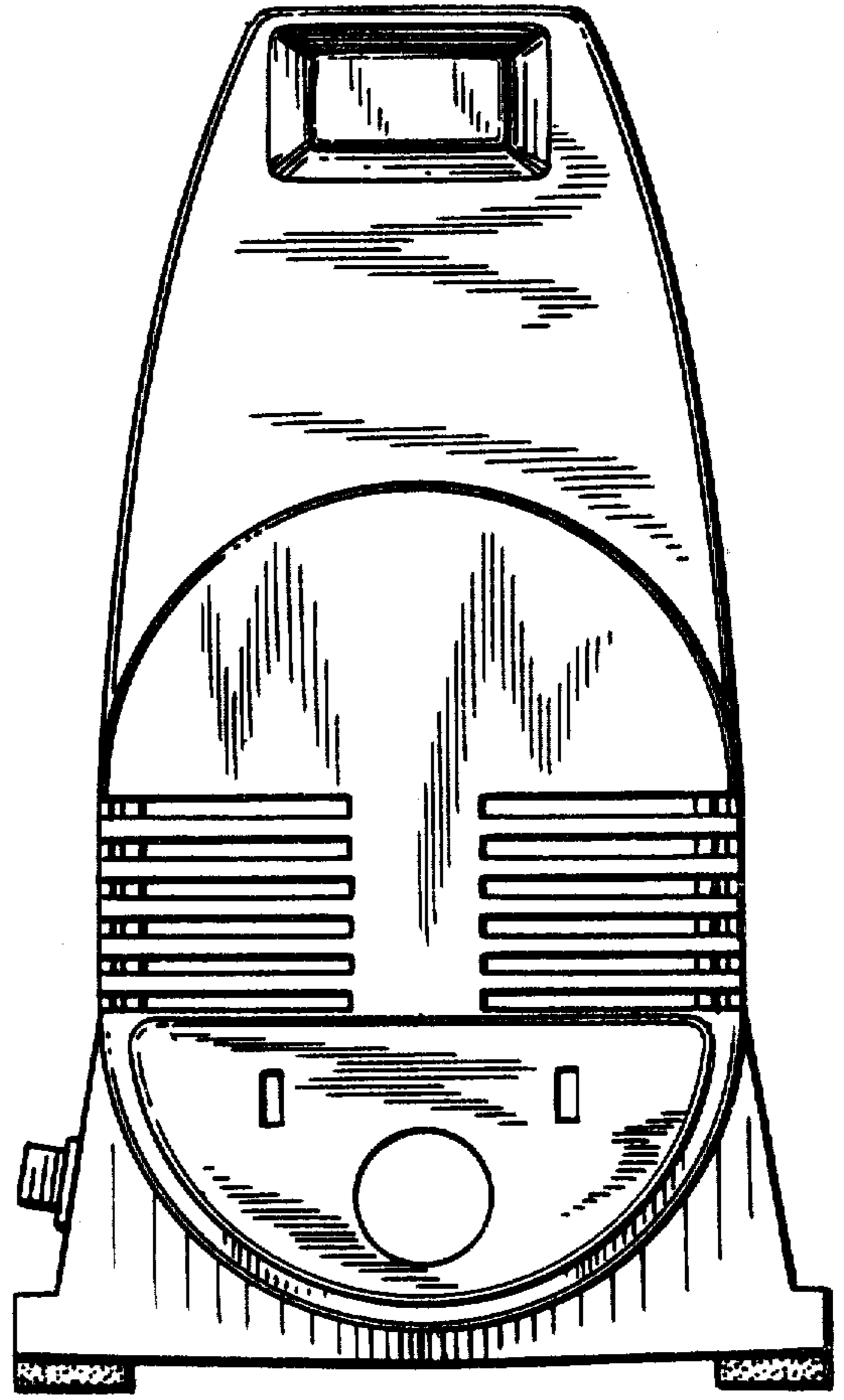
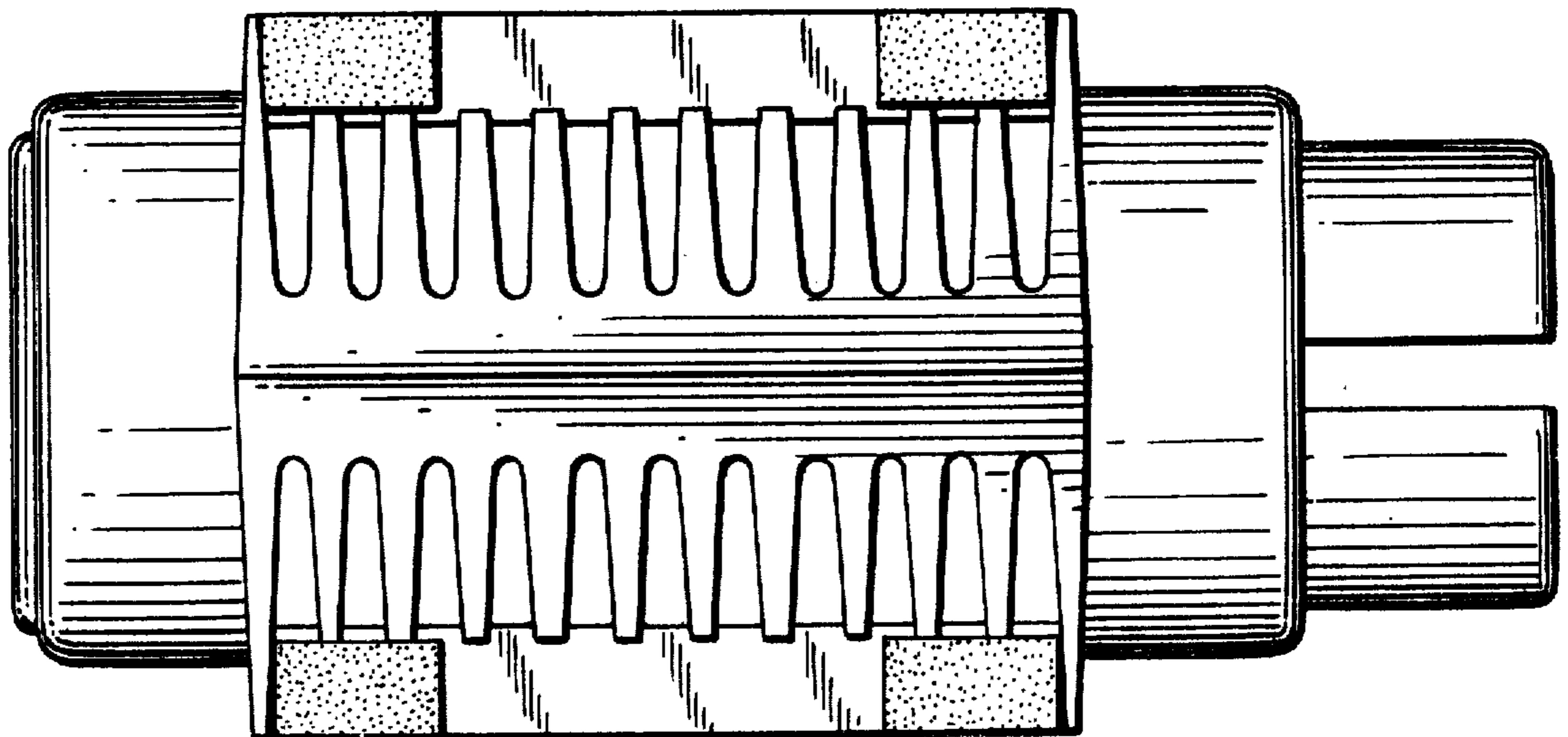

FIG. 6



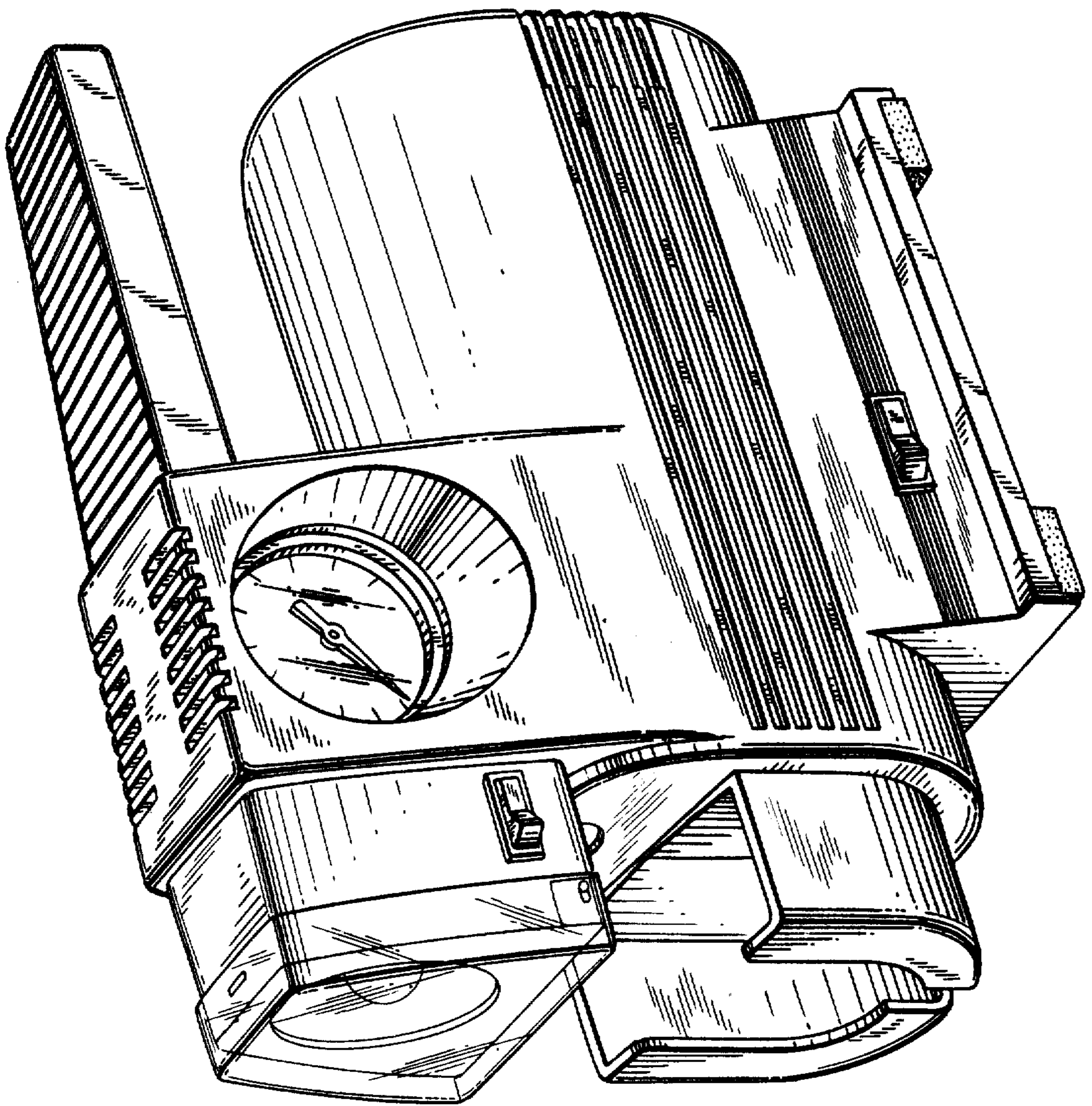

FIG. 7

FIG. 8

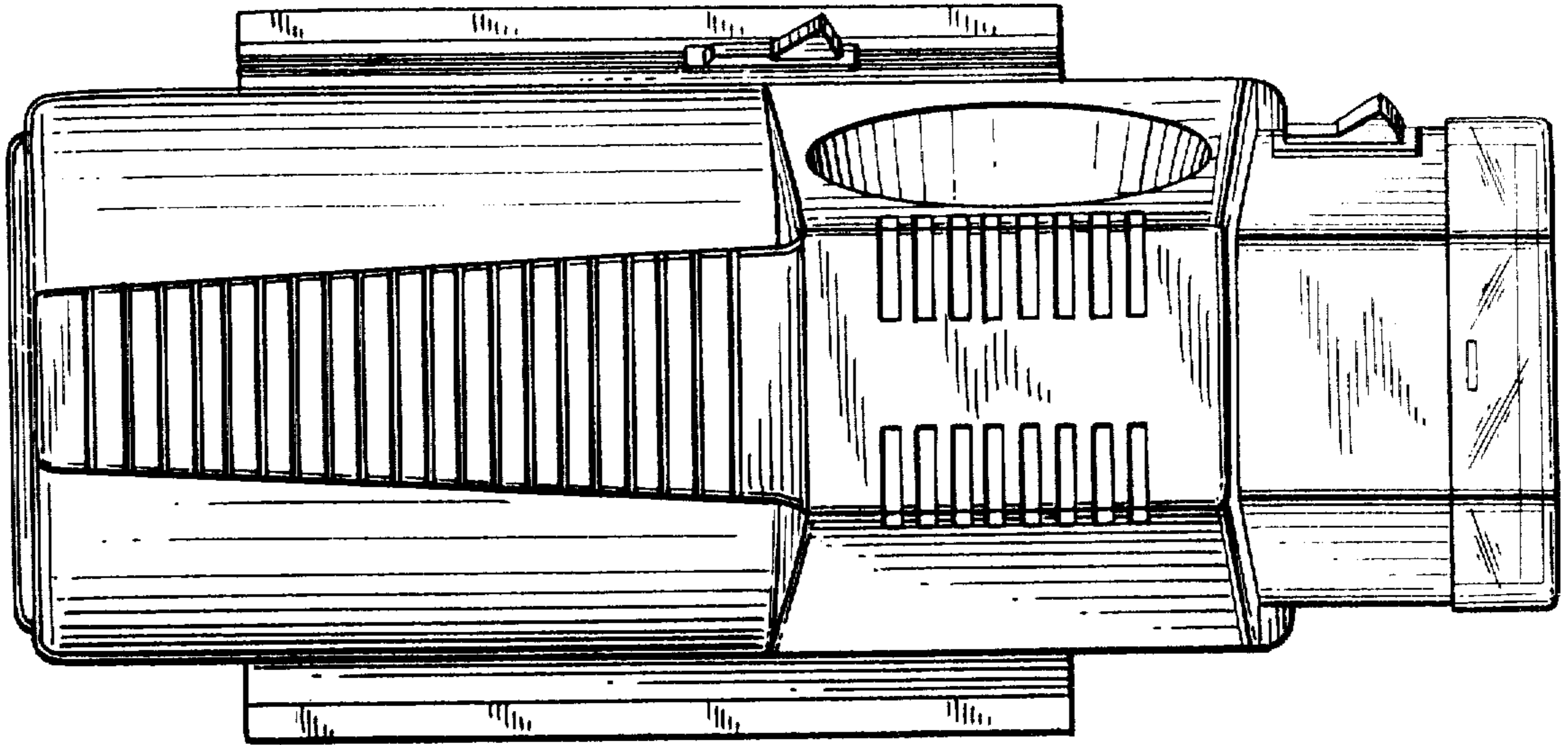

FIG. 9

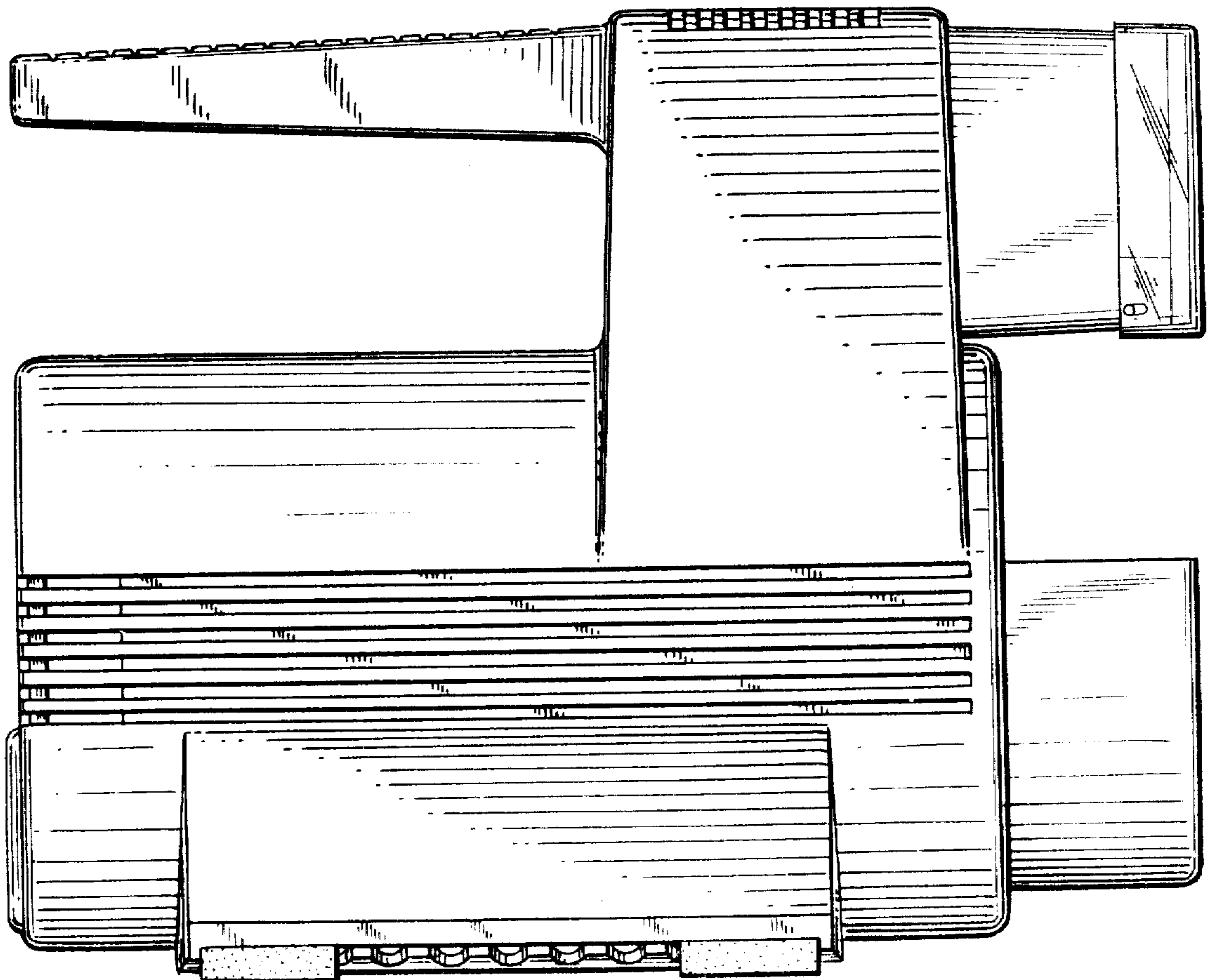

FIG. 10

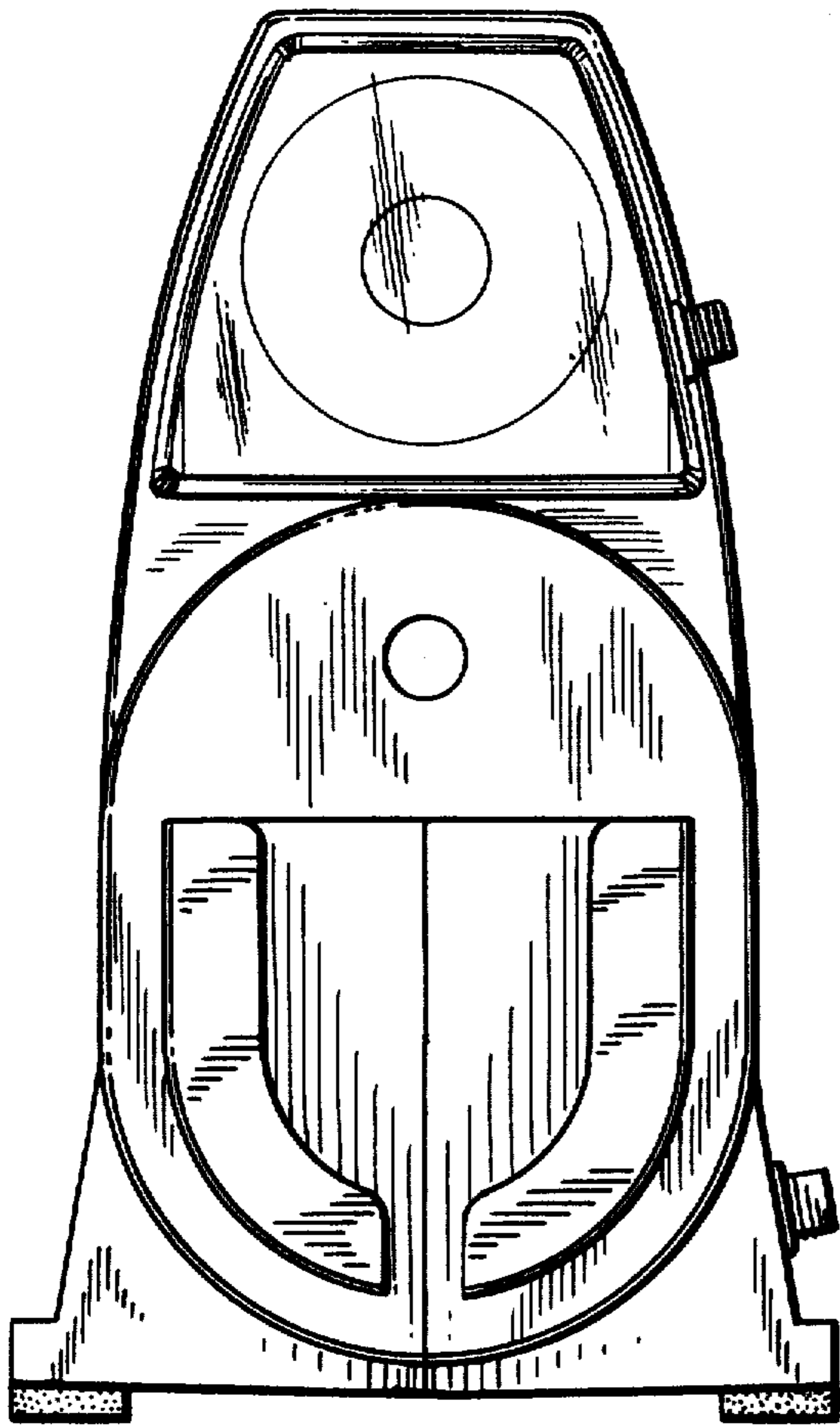

FIG. 11

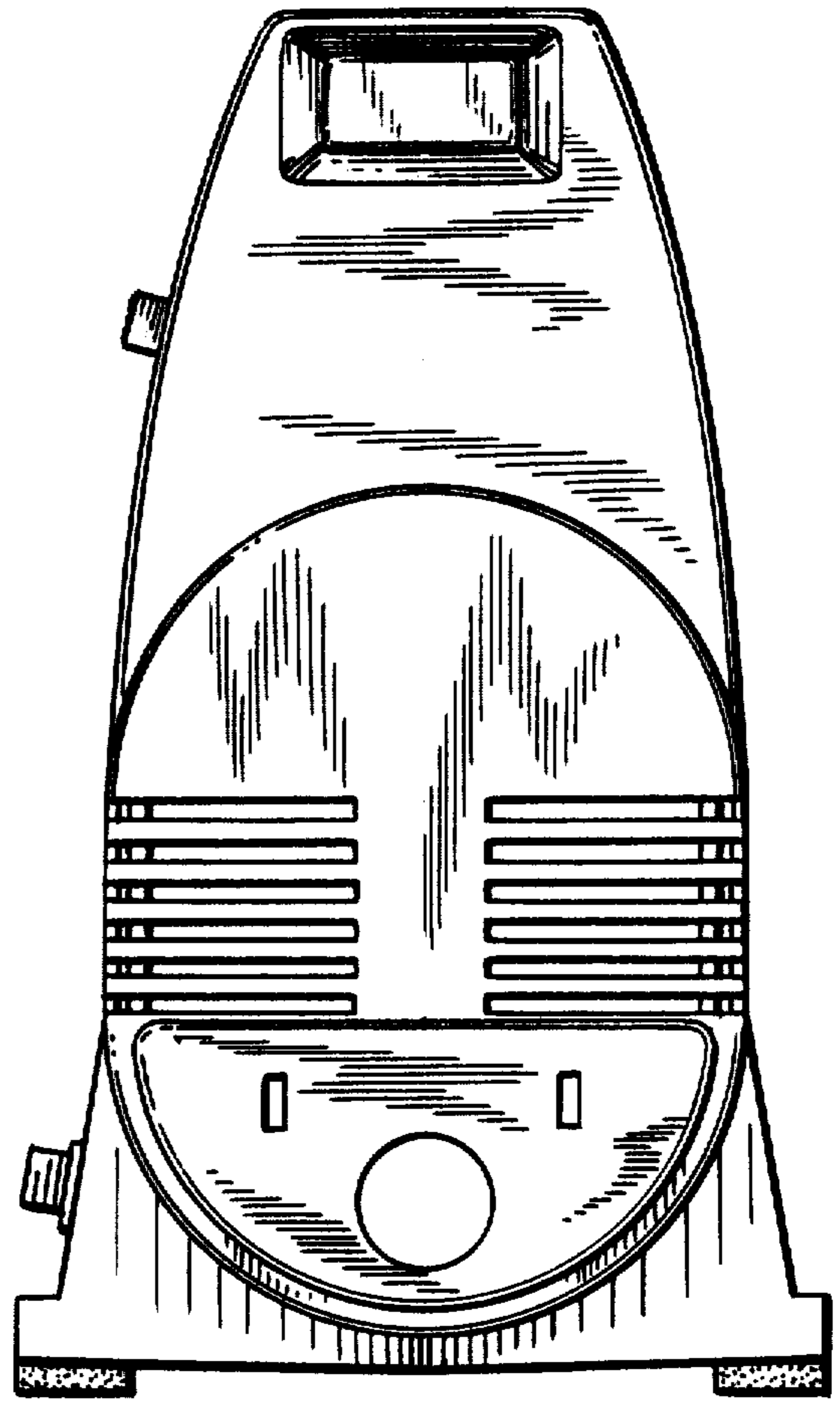

FIG. 12

