

[54] CASE FOR A HAIR ROLLER SET

[75] Inventor: Shinji Yamamoto, Osaka, Japan

[73] Assignee: Matsushita Electric Works, Ltd.,  
Osaka, Japan

[\*\*] Term: 14 Years

[21] Appl. No.: 255,181

[22] Filed: Apr. 17, 1981

[30] Foreign Application Priority Data

Nov. 14, 1980 [JP] Japan ..... 55-47815

[51] Int. Cl. .... D28-03

[52] U.S. Cl. .... D28/38; D28/83

[58] Field of Search ..... D28/73, 76-78,  
D28/81, 83, 84, 91, 38, 67; D3/39; D9/420,  
422, 337, 341, 345, 426; 219/222; 206/235, 581,  
823; 220/DIG. 26; 132/79 R-79 D, 79 F, 79 G,  
82 R-82 G, 83 R-83 H; 362/136, 137

[56] References Cited

U.S. PATENT DOCUMENTS

D. 218,504	8/1970	Pedersen .....	219/222 X
D. 260,305	8/1981	Magregor et al. ....	D28/67
D. 262,579	1/1982	De Haseth .....	D28/83
D. 267,821	2/1983	Guth et al. ....	D28/38
1,978,905	10/1934	Lamb et al. ....	362/136 X
3,586,820	6/1971	Yamanaka .....	219/222

Primary Examiner—Louis S. Zarfaz  
Attorney, Agent, or Firm—Sughrue, Mion, Zinn,  
Macpeak & Seas

[57] CLAIM

The ornamental design for a case for a hair roller set, as shown and described.

DESCRIPTION

FIG. 1 is a front elevational view of a case for a hair roller set showing my new design;  
FIG. 2 is a top plan view thereof;  
FIG. 3 is a rear elevational view thereof;  
FIG. 4 is a bottom plan view thereof;  
FIG. 5 is a left side elevational view thereof;  
FIG. 6 is a front and right side perspective view thereof with the case cover pivoted to open position.

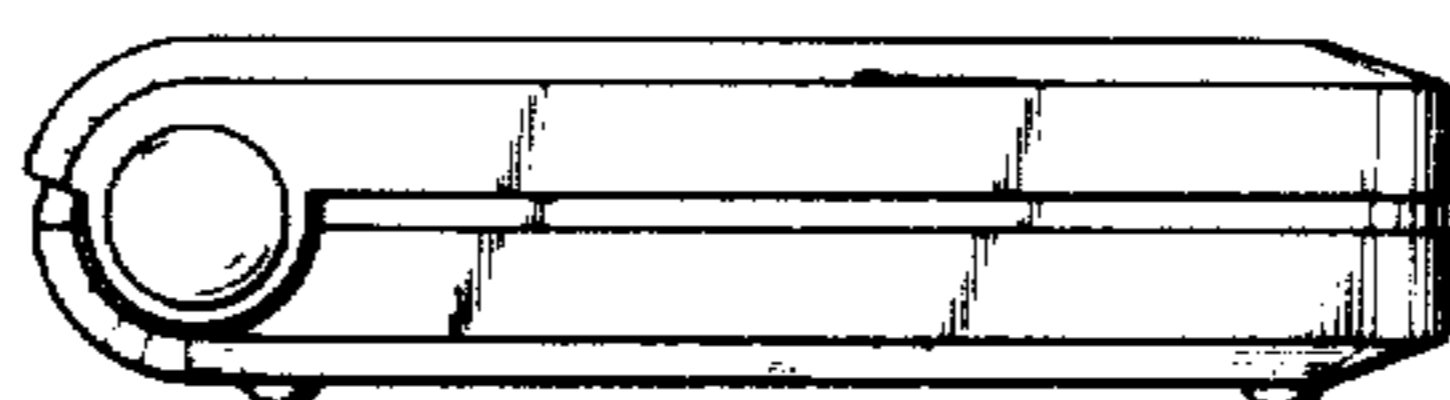
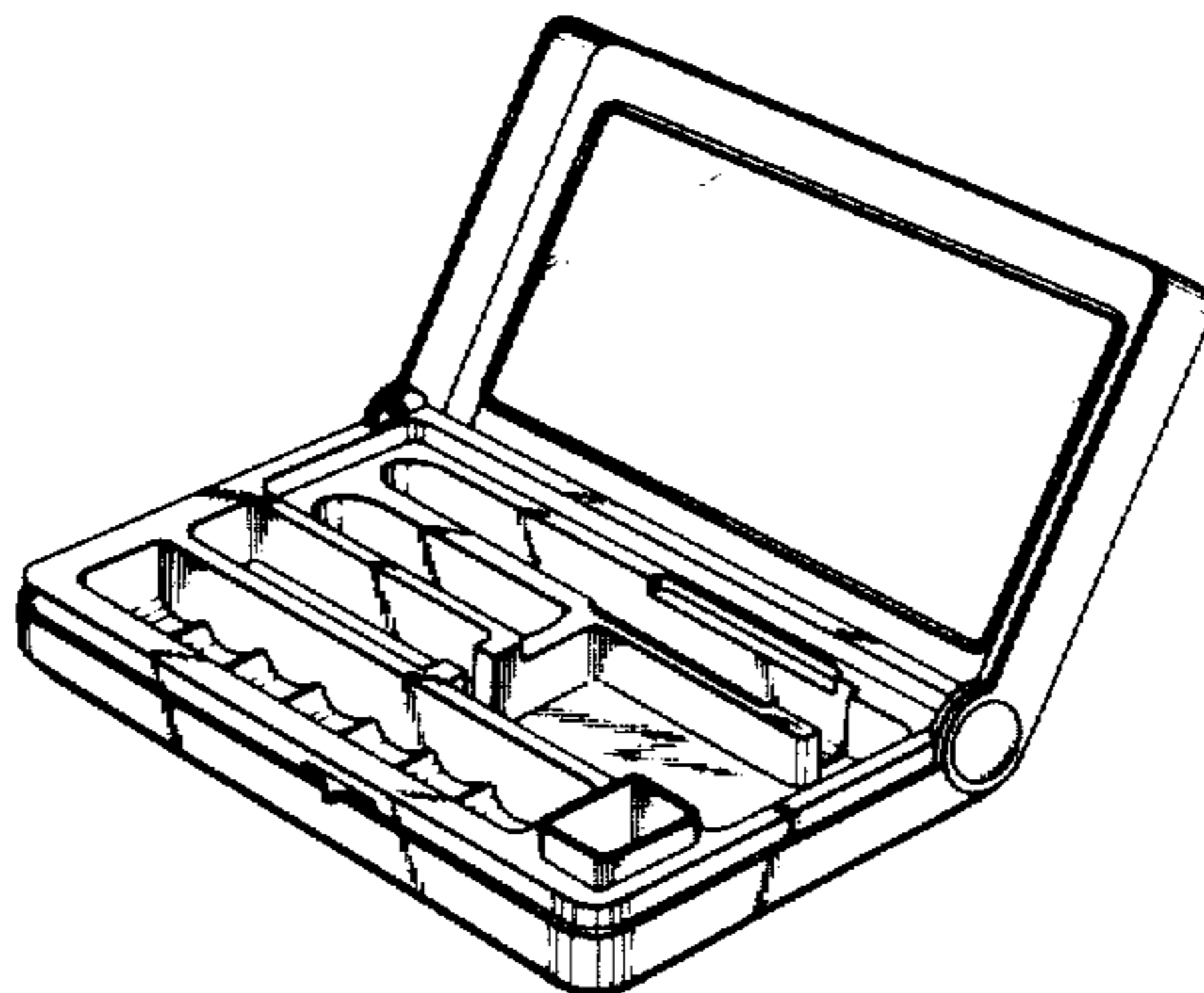
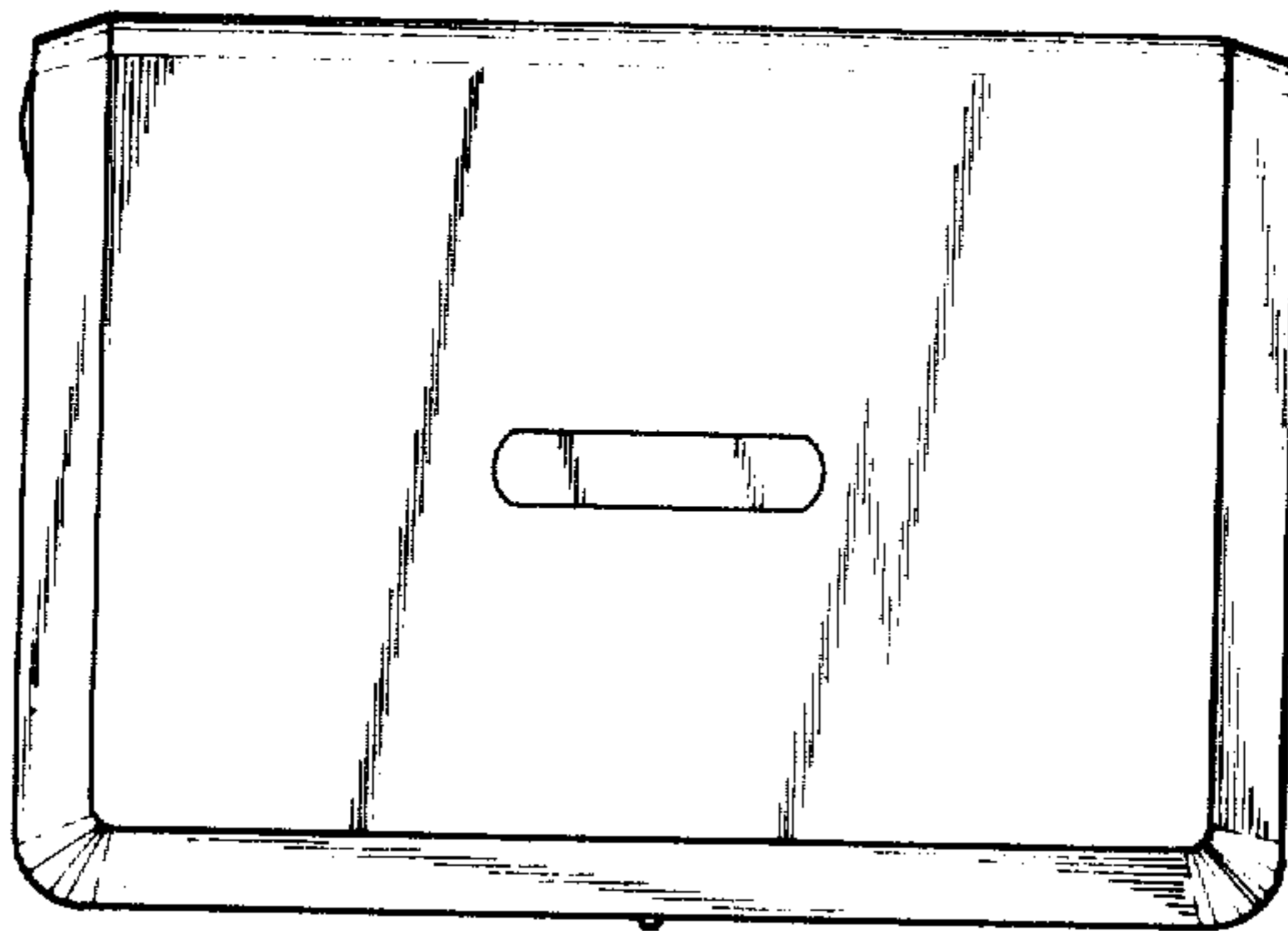

*Fig. 1*

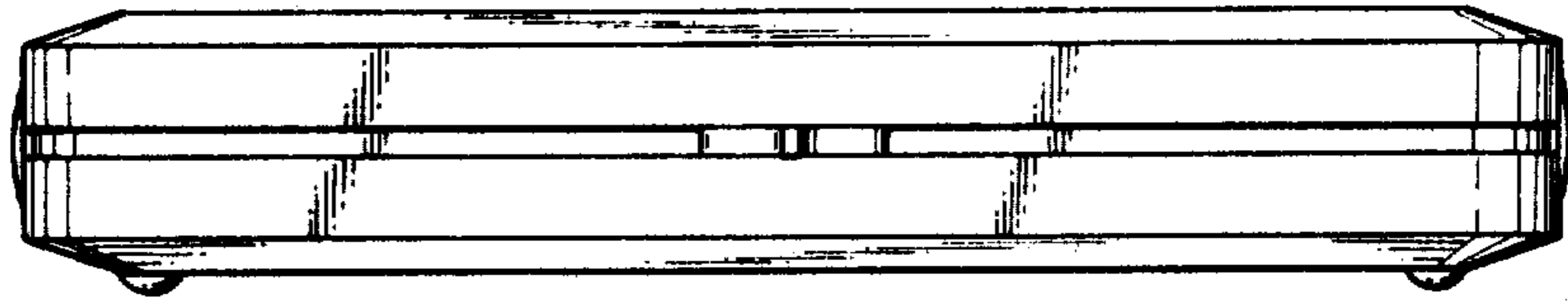

*Fig. 2*

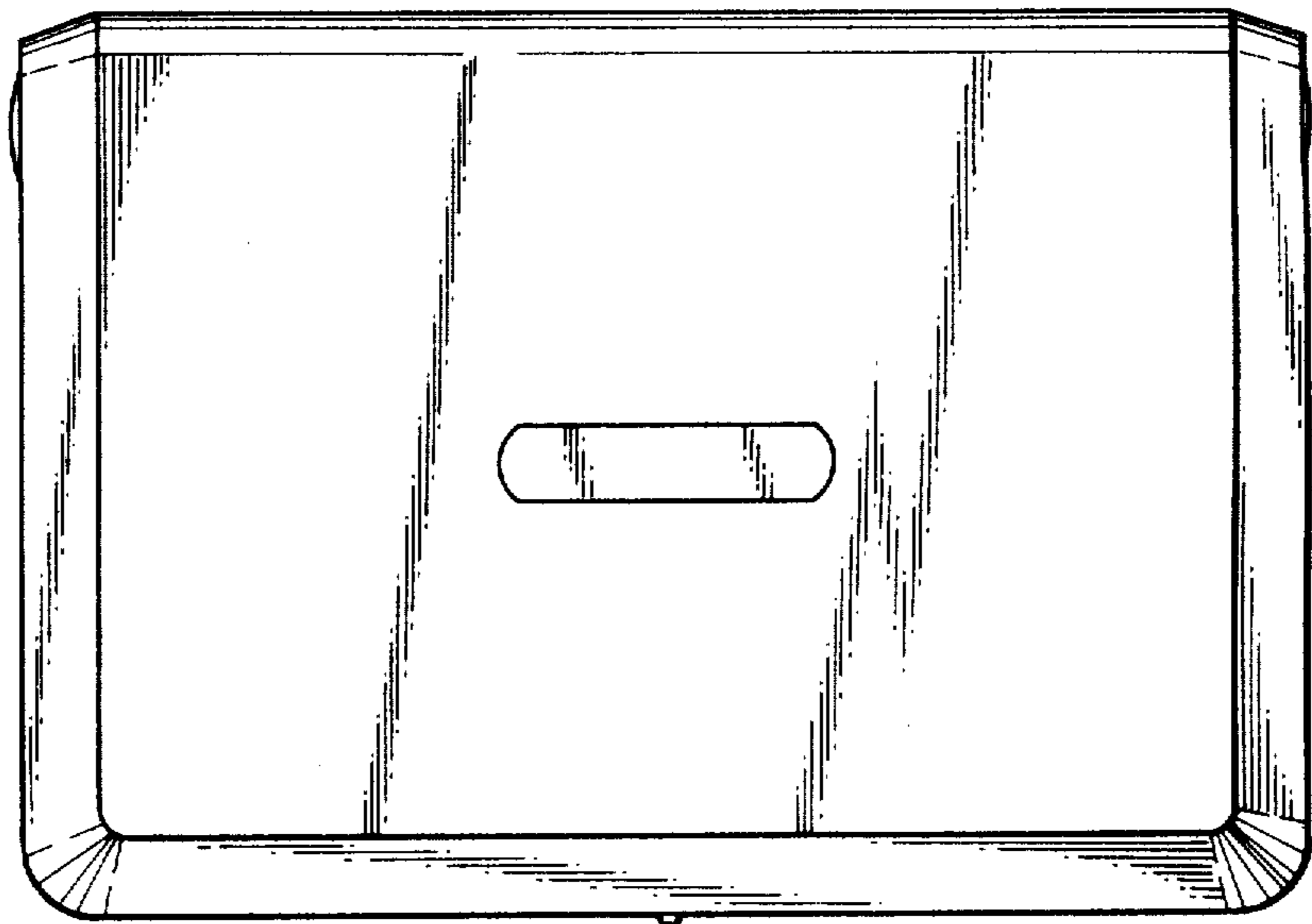

*Fig. 3*

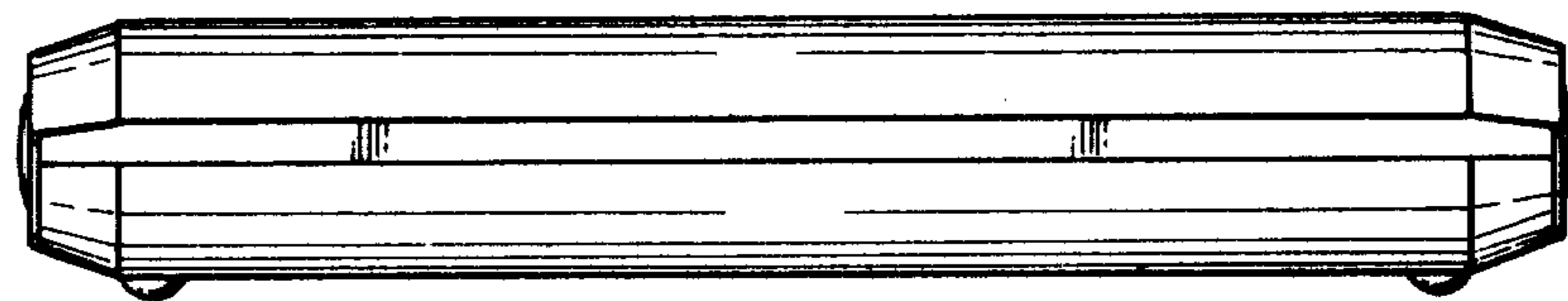

*Fig. 4*

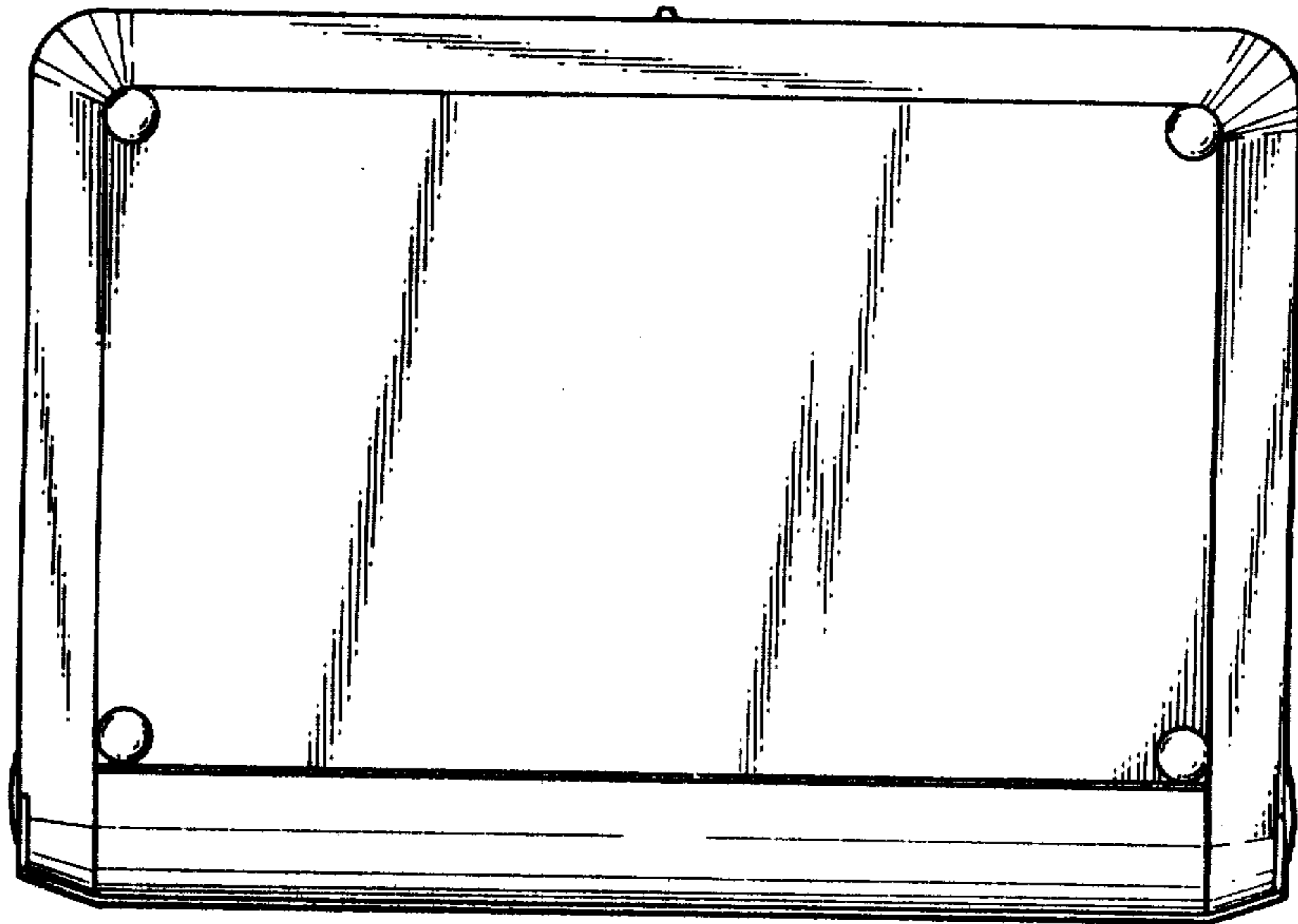

*Fig. 5*

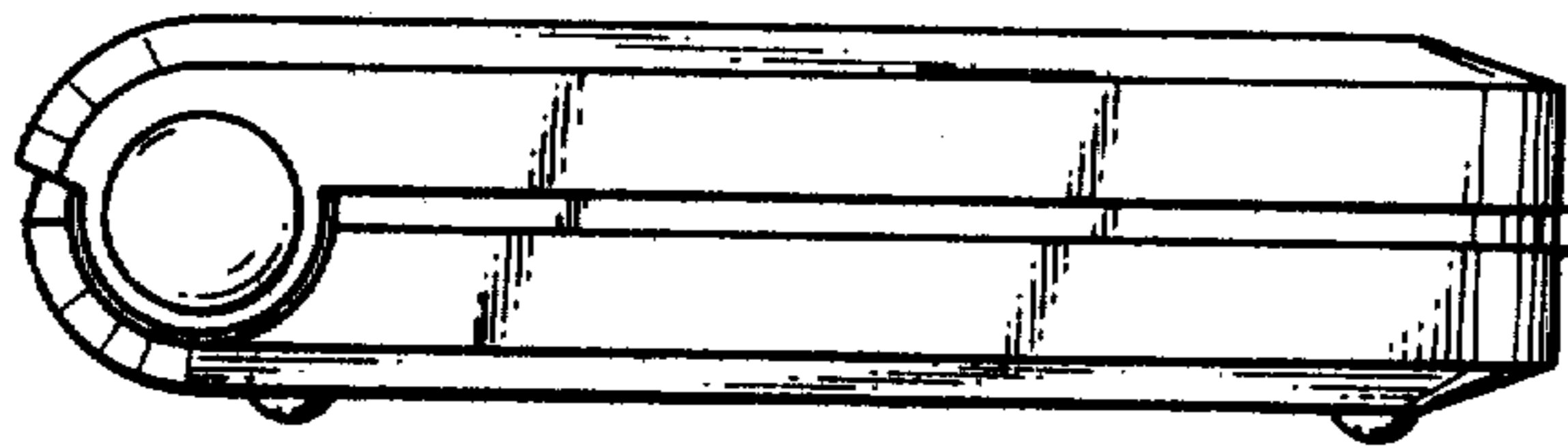

*Fig. 6*

