

[54] SPRAYER

[75] Inventors: **Franco Clivio; Dieter Raffler**, both of
Ulm, Fed. Rep. of Germany

[73] Assignee: **GARDENA Kress & Kastner GmbH**,
Fed. Rep. of Germany

[**] Term: **14 Years**

[21] Appl. No.: **230,148**

[22] Filed: **Jan. 30, 1981**

[30] Foreign Application Priority Data

Aug. 5, 1980 [DE] Fed. Rep. of Germany 1244/80

[51] Int. Cl. **D23-01**

[52] U.S. Cl. **D23/37**

[58] Field of Search **D23/17, 18, 34-38;**
239/526-528

[56] References Cited

U.S. PATENT DOCUMENTS

D. 145,085 6/1946 Isenberg D23/35

D. 145,538	9/1946	Richards	D23/35
D. 148,892	3/1948	Swimmer	D23/37
D. 170,447	9/1953	Caird	D23/37
D. 177,354	4/1956	Wagler	D23/35
D. 180,486	6/1957	Koeppel	D23/37
D. 207,440	4/1967	Bucknell et al.	D23/35
D. 225,736	1/1973	Mango et al.	D23/37
D. 251,679	4/1979	Kwan	D23/35

Primary Examiner—James R. Largen
Attorney, Agent, or Firm—Steele, Gould & Fried

[57] CLAIM

The ornamental design for a sprayer, as shown or described.

DESCRIPTION

FIG. 1 is a left side elevational view of a sprayer showing our new design, the right side being a mirror image of the left side shown;
FIG. 2 is a bottom plan view thereof;
FIG. 3 is a rear elevational view thereof;
FIG. 4 is a perspective view taken from the top and rear thereof; and
FIG. 5 is a front elevational view thereof.

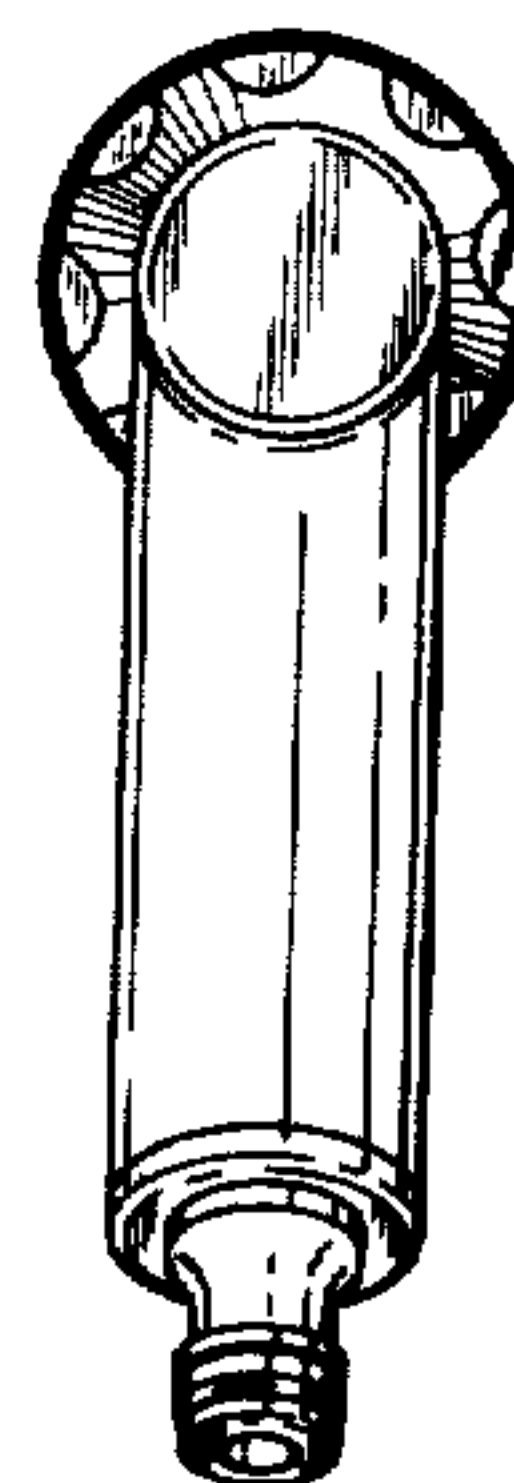
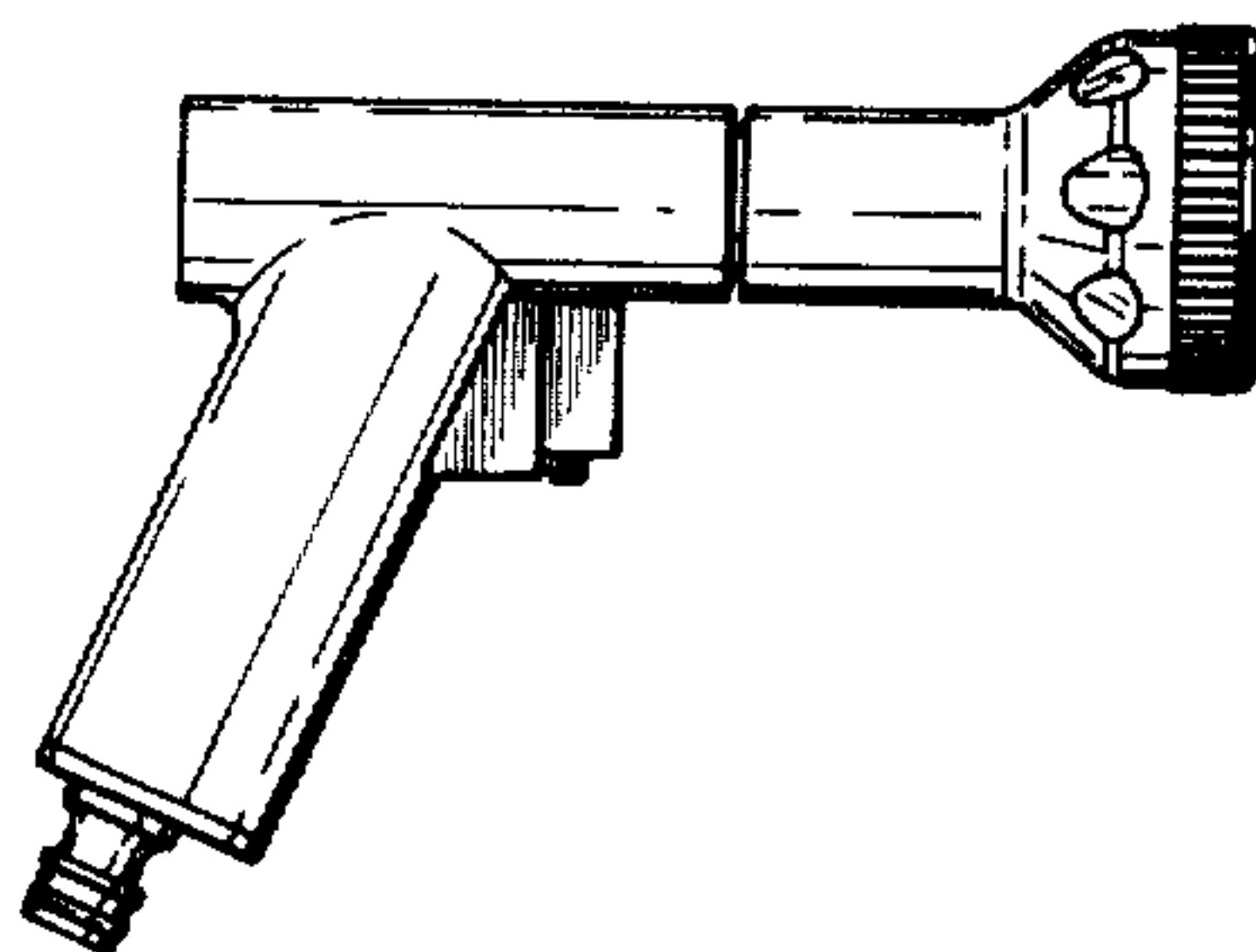

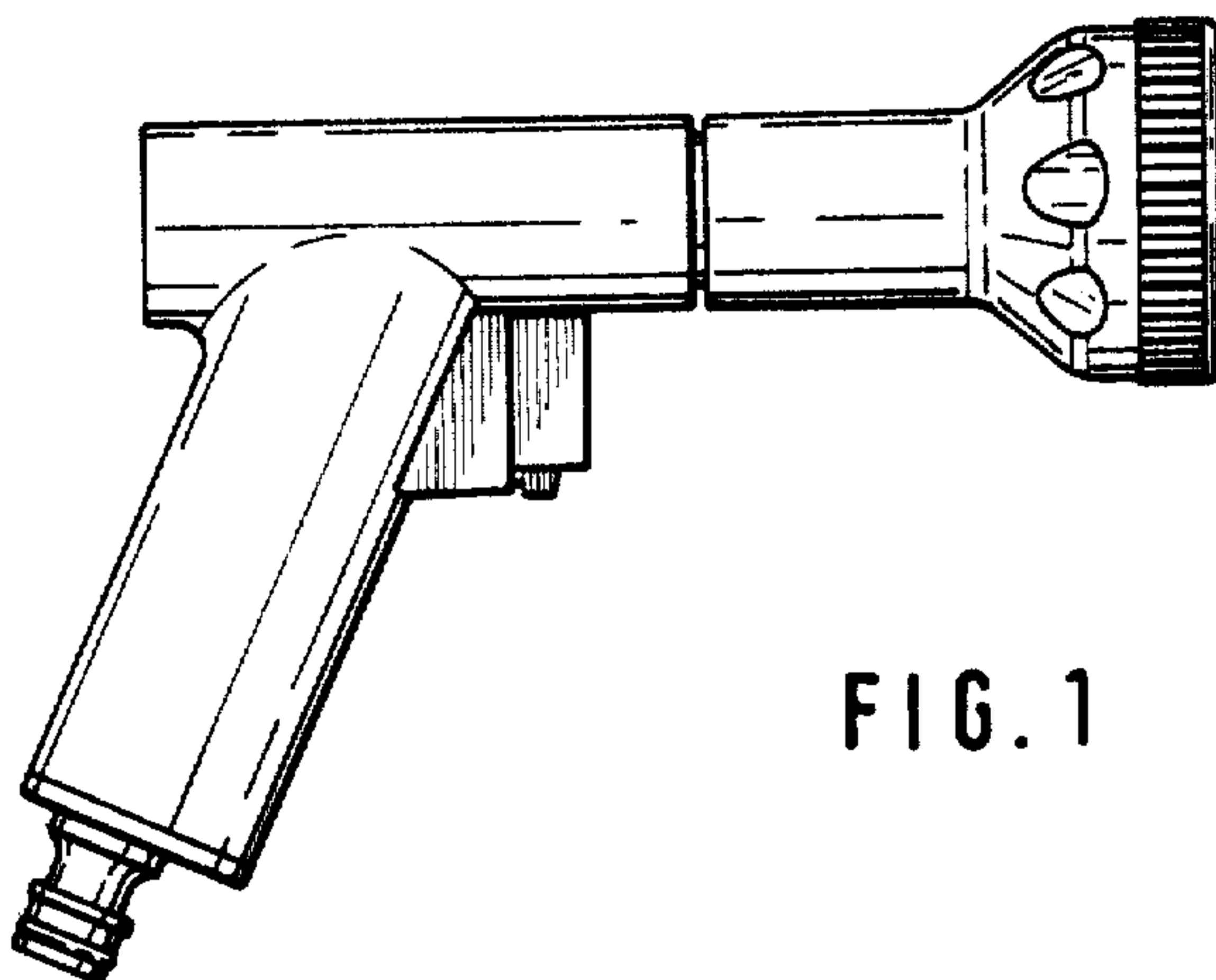

FIG. 1

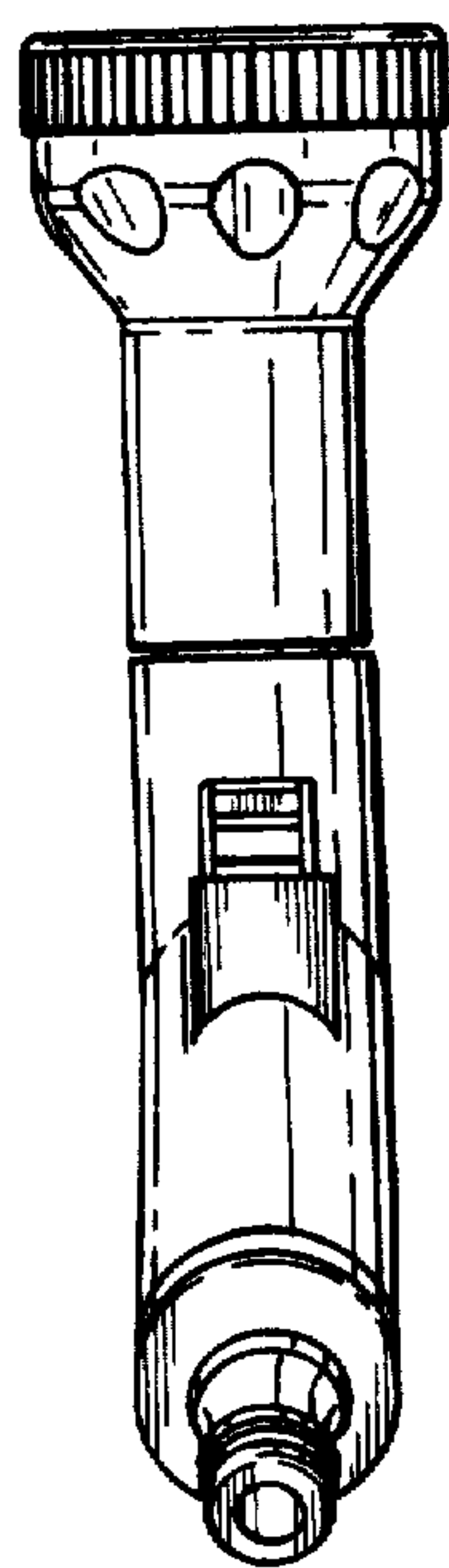

FIG. 2

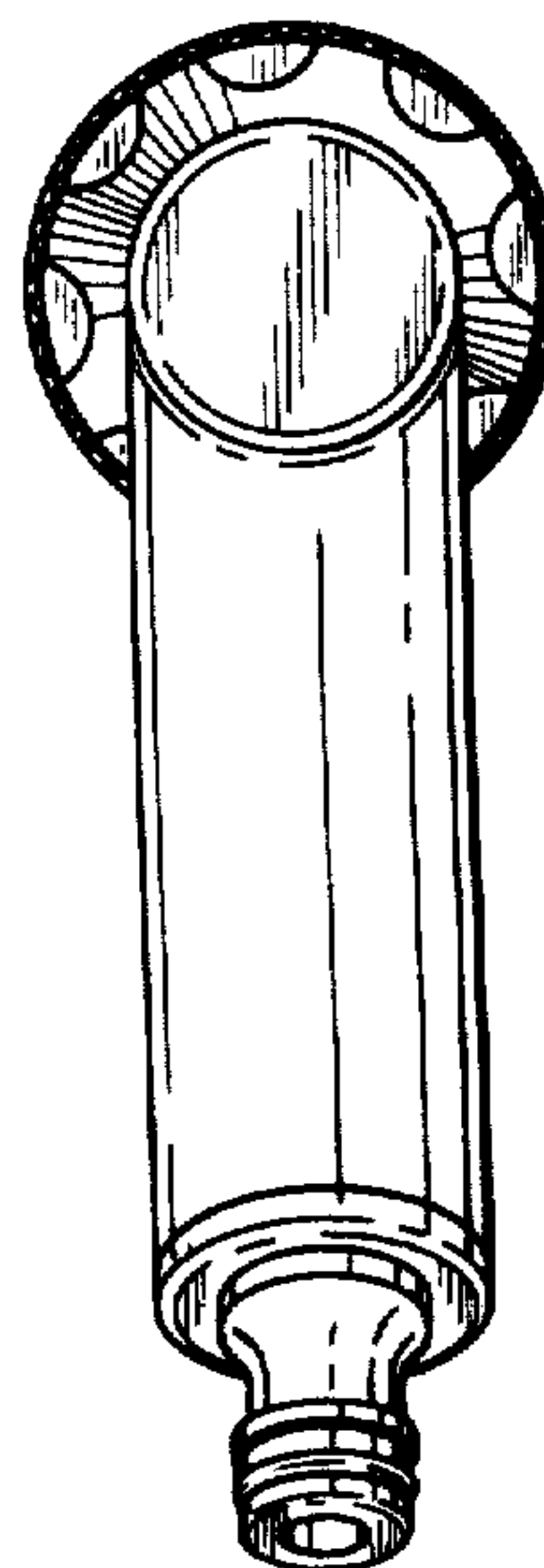

FIG. 3

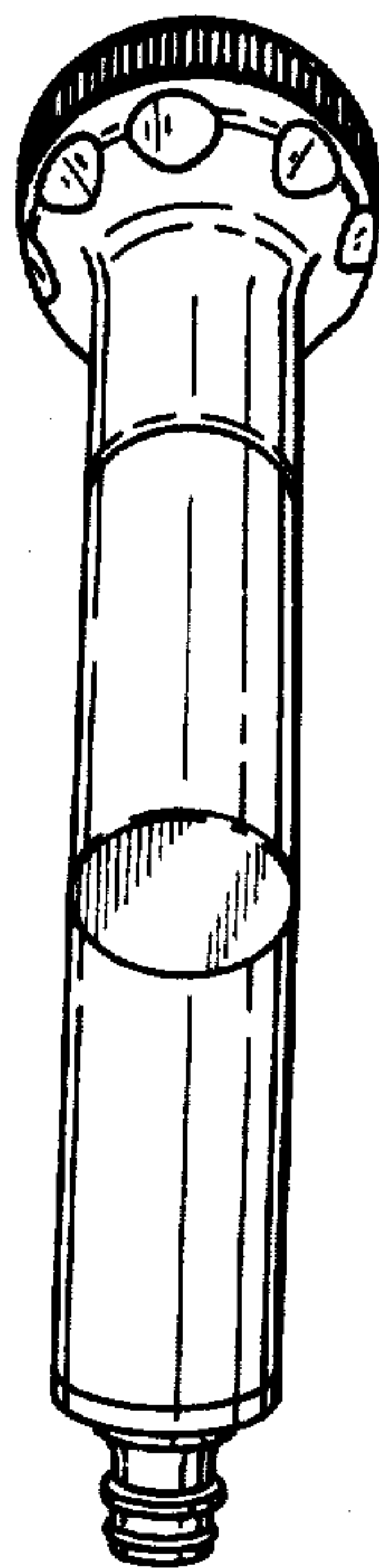

FIG. 4

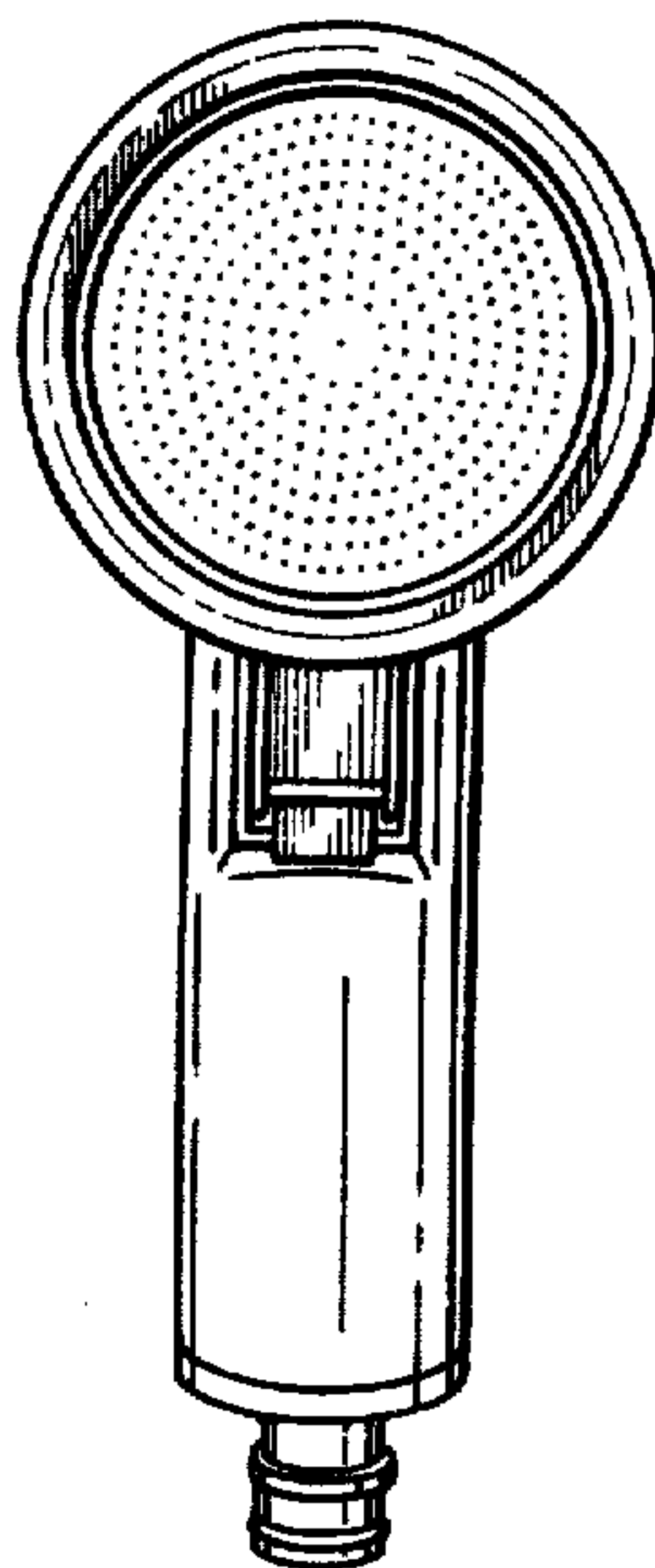

FIG. 5