

- [54] **PITCHER OR THE LIKE**
- [75] Inventor: Ann K. Fritz, Auburndale, Mass.
- [73] Assignee: Dart Industries Inc., Northbrook, Ill.
- [**] Term: 14 Years
- [21] Appl. No.: 272,834
- [22] Filed: Jun. 12, 1981

Related U.S. Application Data

- [63] Continuation-in-part of Ser. No. 60,554, Jul. 25, 1979, abandoned.
- [51] Int. Cl. D07—01
- [52] U.S. Cl. D7/319; D7/50
- [58] Field of Search D7/64, 65, 62, 59, 60, D7/63, 66, 67, 77, 41, 9, 70, 50

[56] **References Cited**

U.S. PATENT DOCUMENTS

D. 180,049	4/1957	Tupper	D7/60
D. 220,773	5/1971	Dilyard	D7/65
D. 229,012	11/1973	Wooters	D7/65
D. 236,177	8/1975	Reyda	D7/62
D. 236,178	8/1975	Young	D7/62
D. 246,413	11/1977	Wildgen	D7/64
D. 247,604	3/1978	Wildgen	D7/65
D. 248,917	8/1978	Kikuchi	D7/65
3,964,629	6/1976	McCabe	D7/71 X

OTHER PUBLICATIONS

Retailing Home Furnishings, Sec. one H.F.D., 9-1-8-1978, p. 39, *Plastics From I.P.I.*, Milan (Holt-Howard), Pitcher shown.
Better Homes & Gardens, Sep. 1977, p. 19, Rubbermaid Avd. Clear Measuring Cups, 3 Sizes shown, left center of page.
Stile Industria, #33, 8-1961, p. 21, Tableware Series TC

100 for Restaurants, bottom panel stacked pitchers shown 3rd in from left.
Home Fashion Blooms Fresh at Woodies Advertising Supplement to Wash. Star., Sunday May 9, 1976, p. 20, Item B, C. Rubbermaid covered pitcher, stacked pitchers, top right panel.

Primary Examiner—Winifred E. Herrmann
 Attorney, Agent, or Firm—John A. Doninger

[57] **CLAIM**

The ornamental design for a pitcher or the like, substantially as shown and described.

DESCRIPTION

FIG. 1 is a top perspective view of the pitcher or the like, showing my new design;
 FIG. 2 is a front elevational view thereof;
 FIG. 3 is a left side elevational view thereof;
 FIG. 4 is a rear elevational view thereof;
 FIG. 5 is a top plan view thereof;
 FIG. 6 is a bottom plan view thereof;
 FIG. 7 is a cross-sectional view thereof taken along line 7-7 of FIG. 5;
 FIG. 8 is a right side elevational view thereof;
 FIG. 9 is a right side elevational view of a modified form of the pitcher or the like of FIG. 1;
 FIG. 10 is a rear elevational view thereof;
 FIG. 11 is a front elevational view thereof;
 FIG. 12 is a top plan view thereof;
 FIG. 13 is a bottom plan view thereof;
 FIG. 14 is a right side elevational view of another modified form of the pitcher or the like of FIG. 1;
 FIG. 15 is a rear elevational view thereof;
 FIG. 16 is a front elevational view thereof;
 FIG. 17 is a top plan view thereof; and
 FIG. 18 is a bottom plan view thereof.

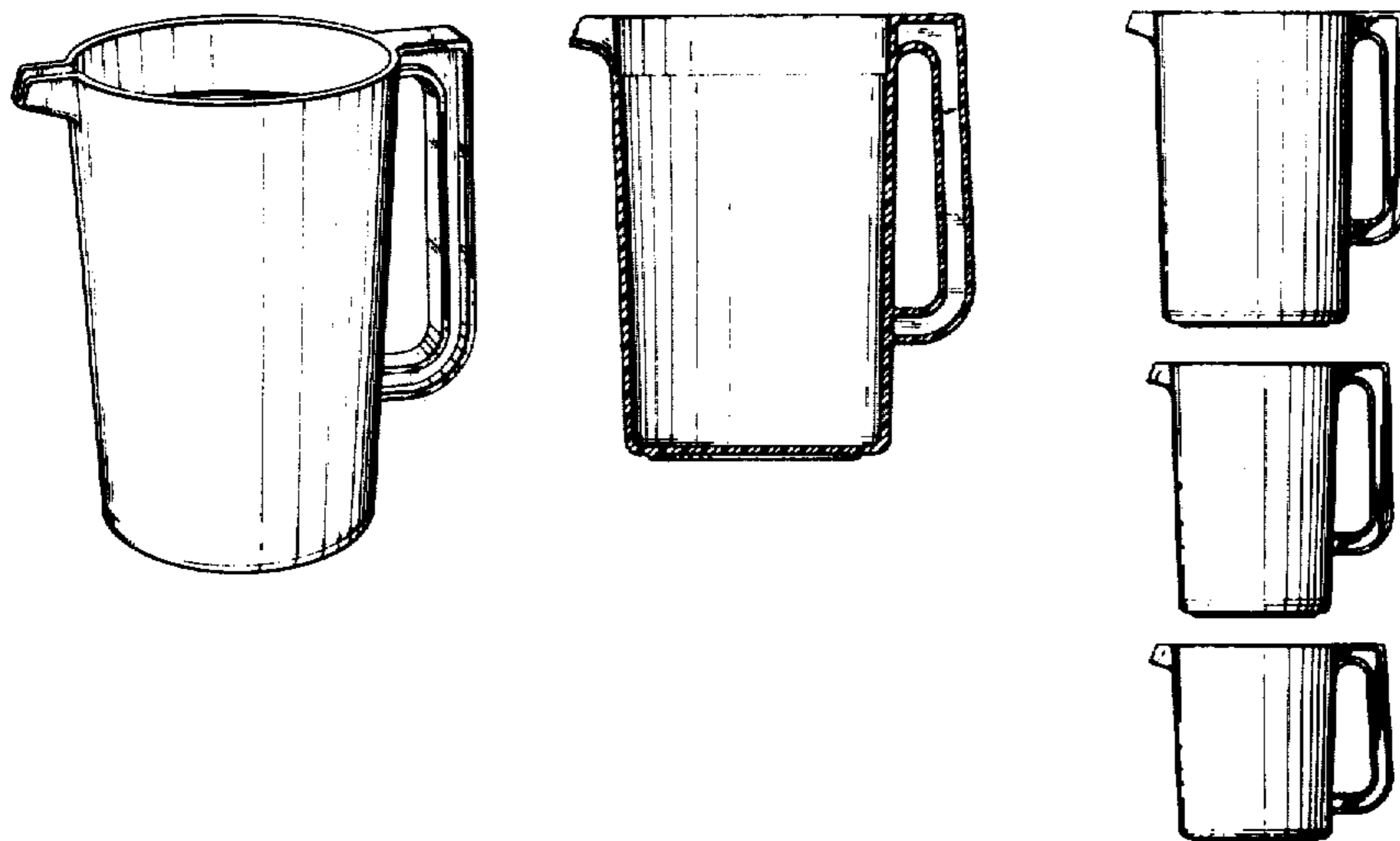

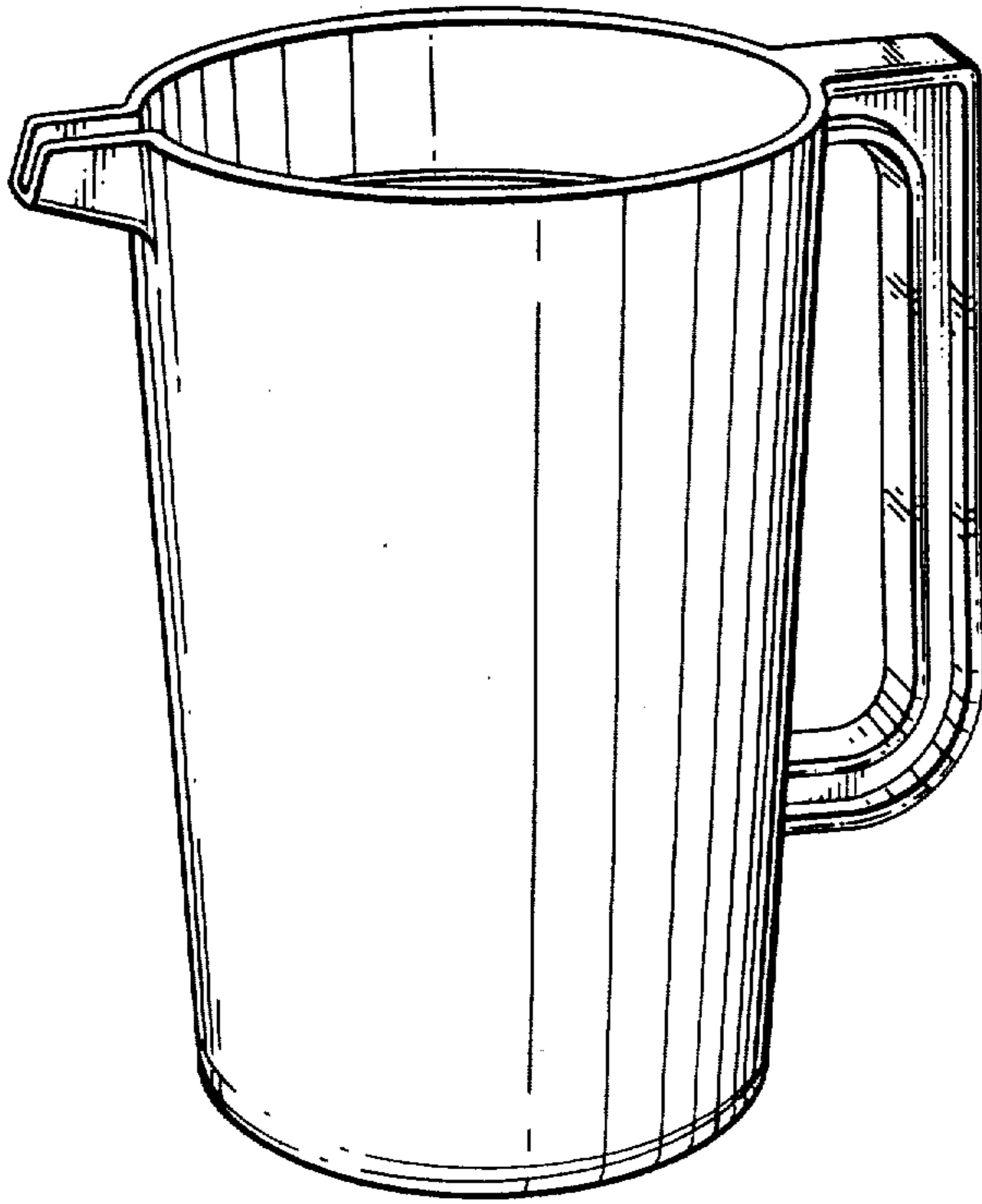

FIG. 1

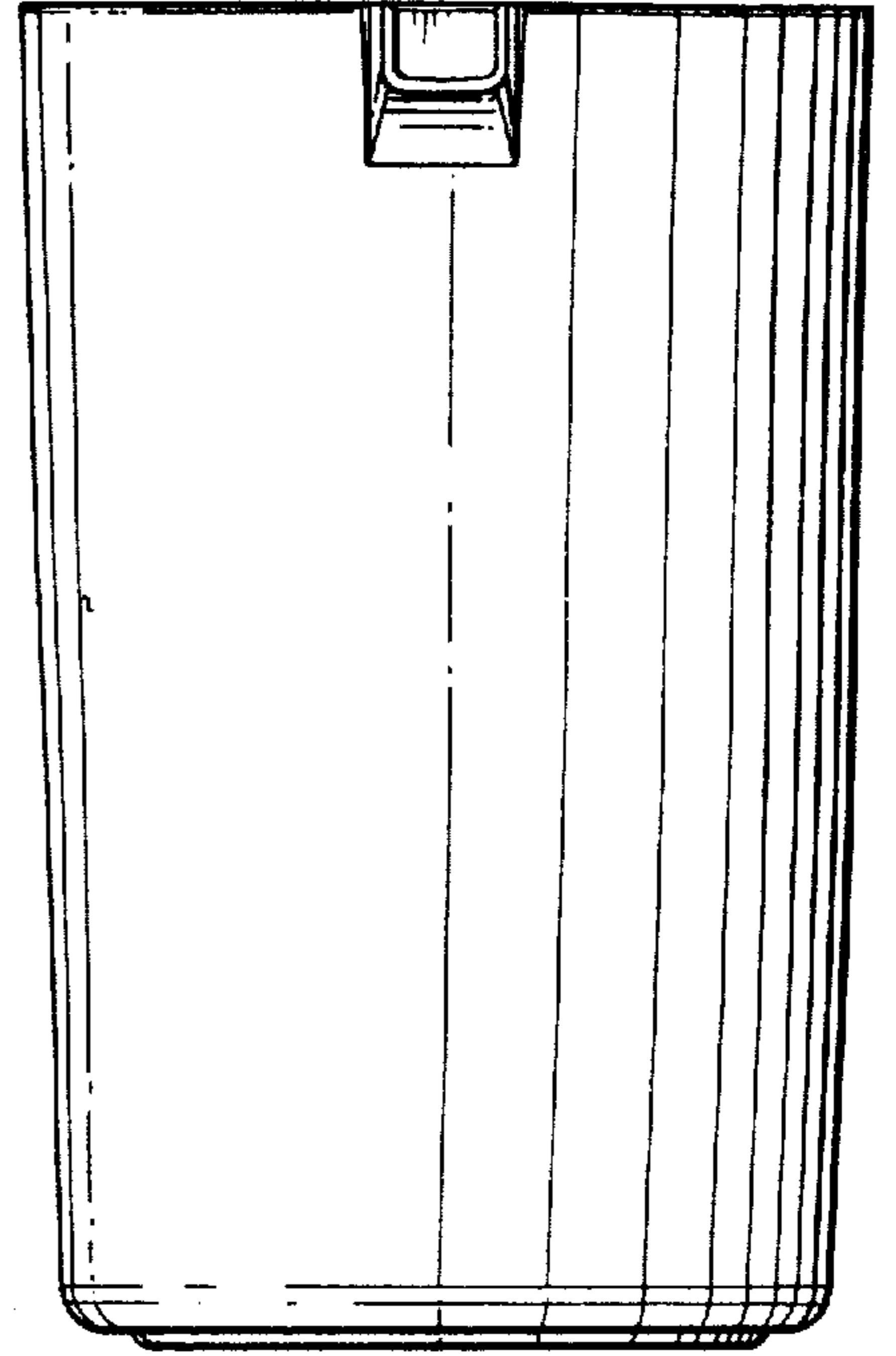

FIG. 2

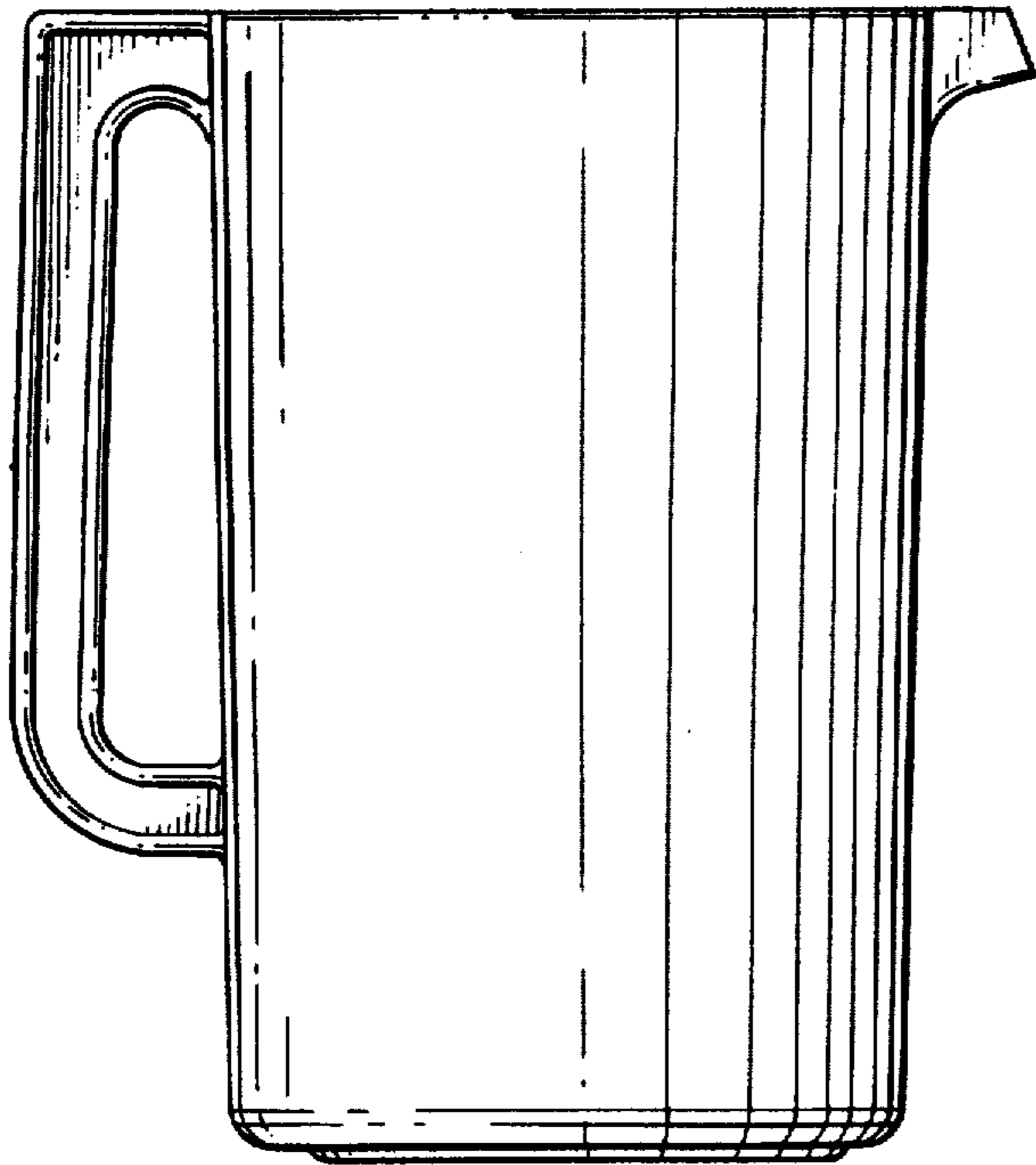

FIG. 3

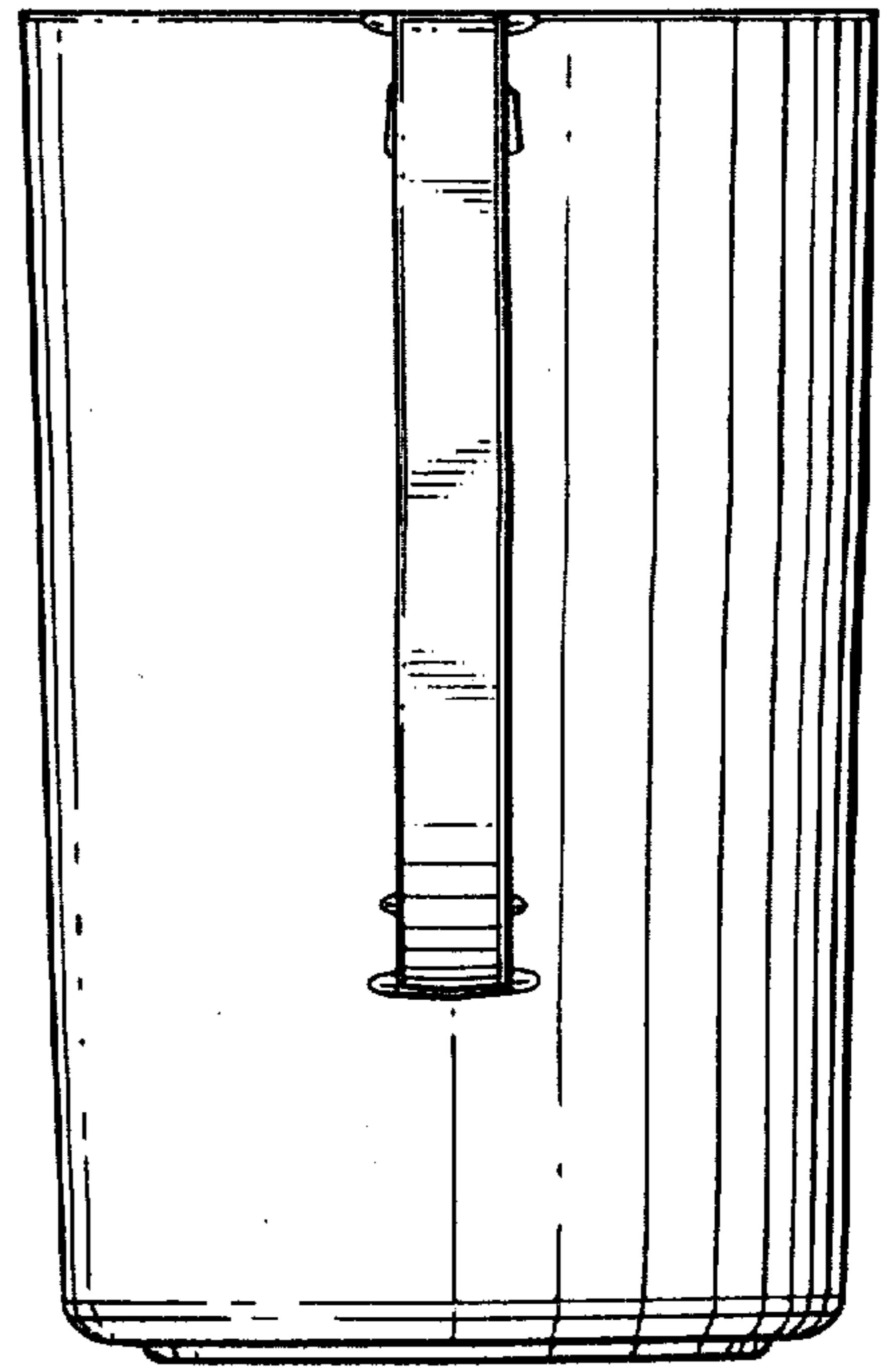

FIG. 4

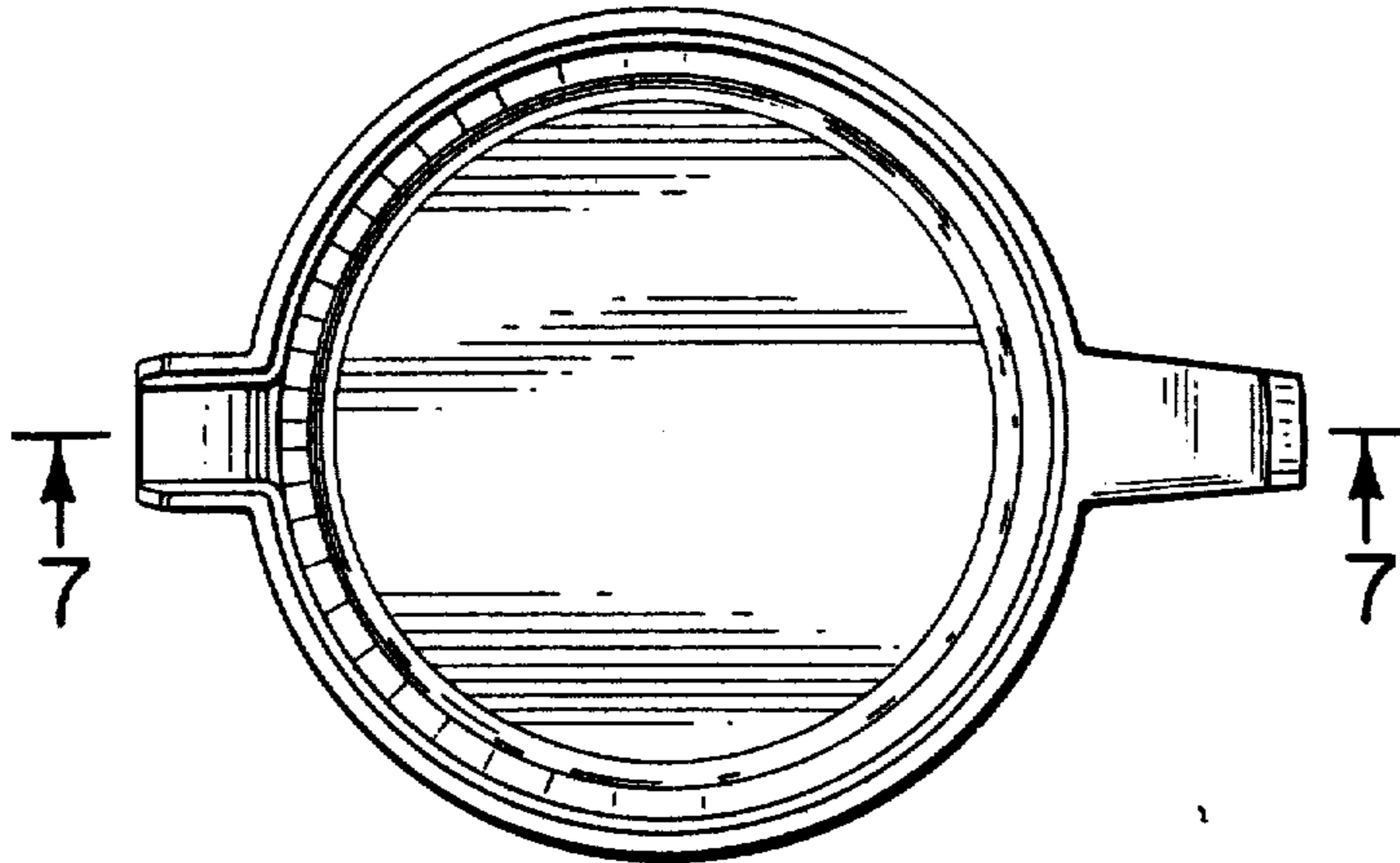

FIG. 5

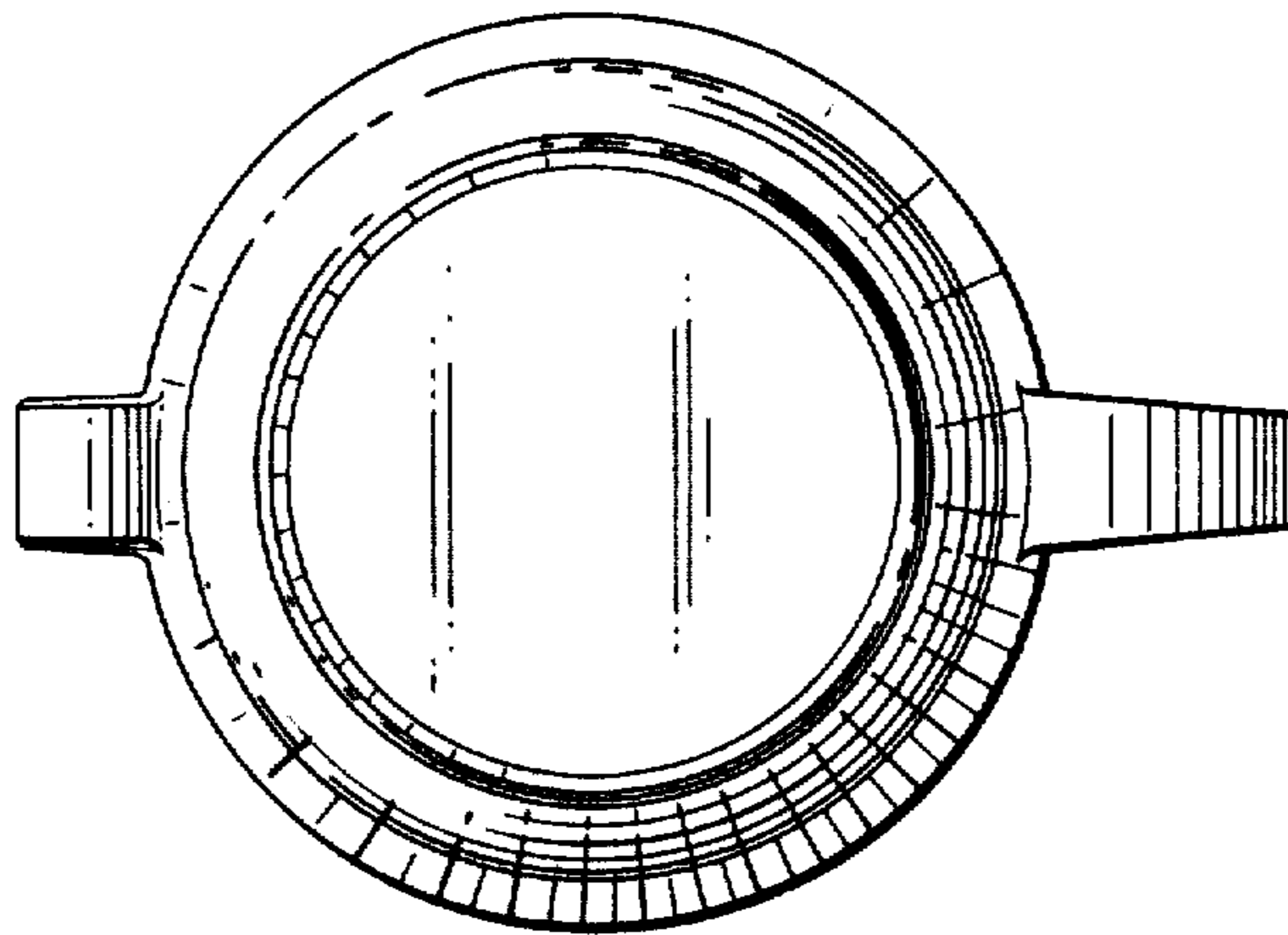

FIG. 6

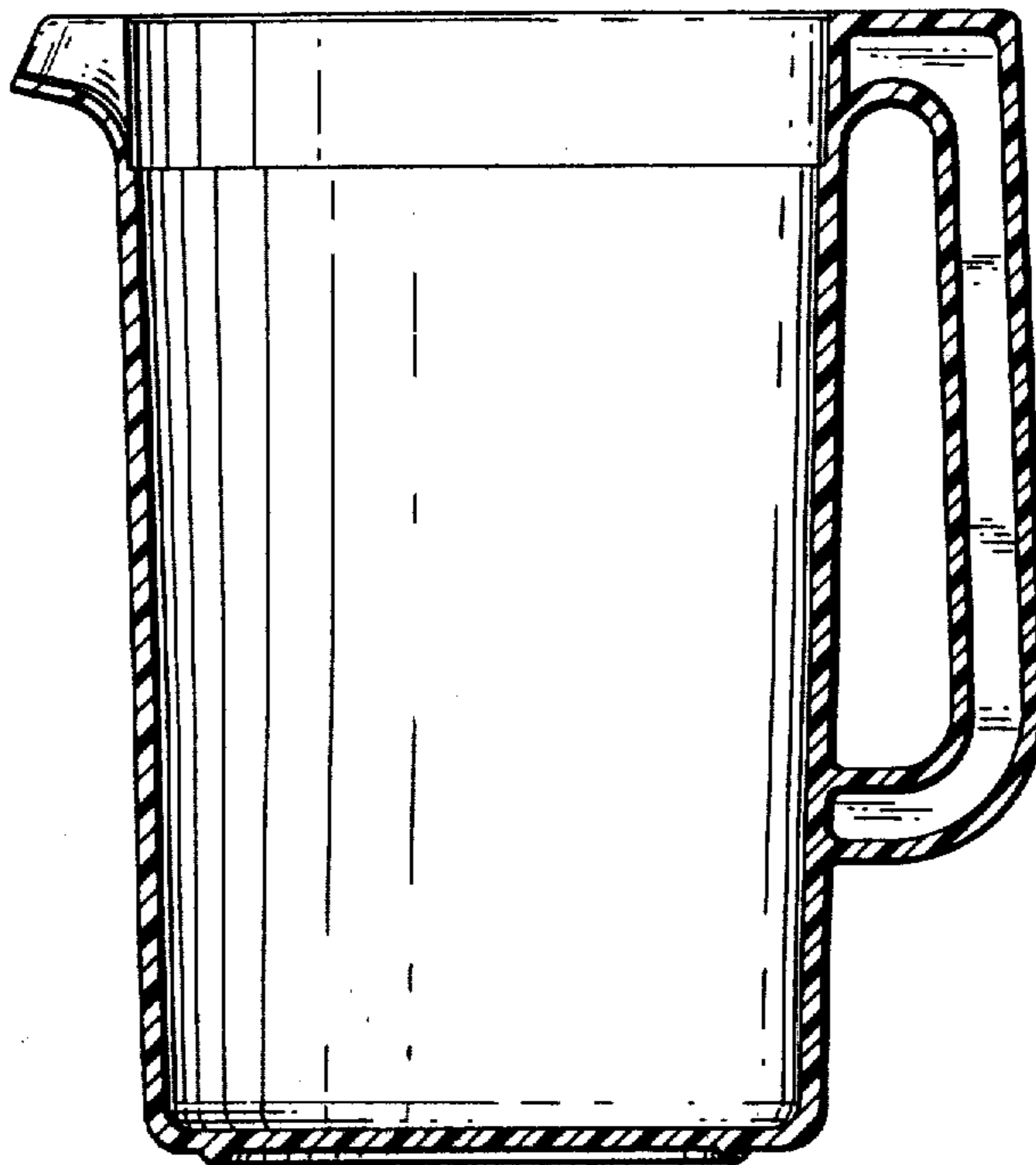

FIG. 7

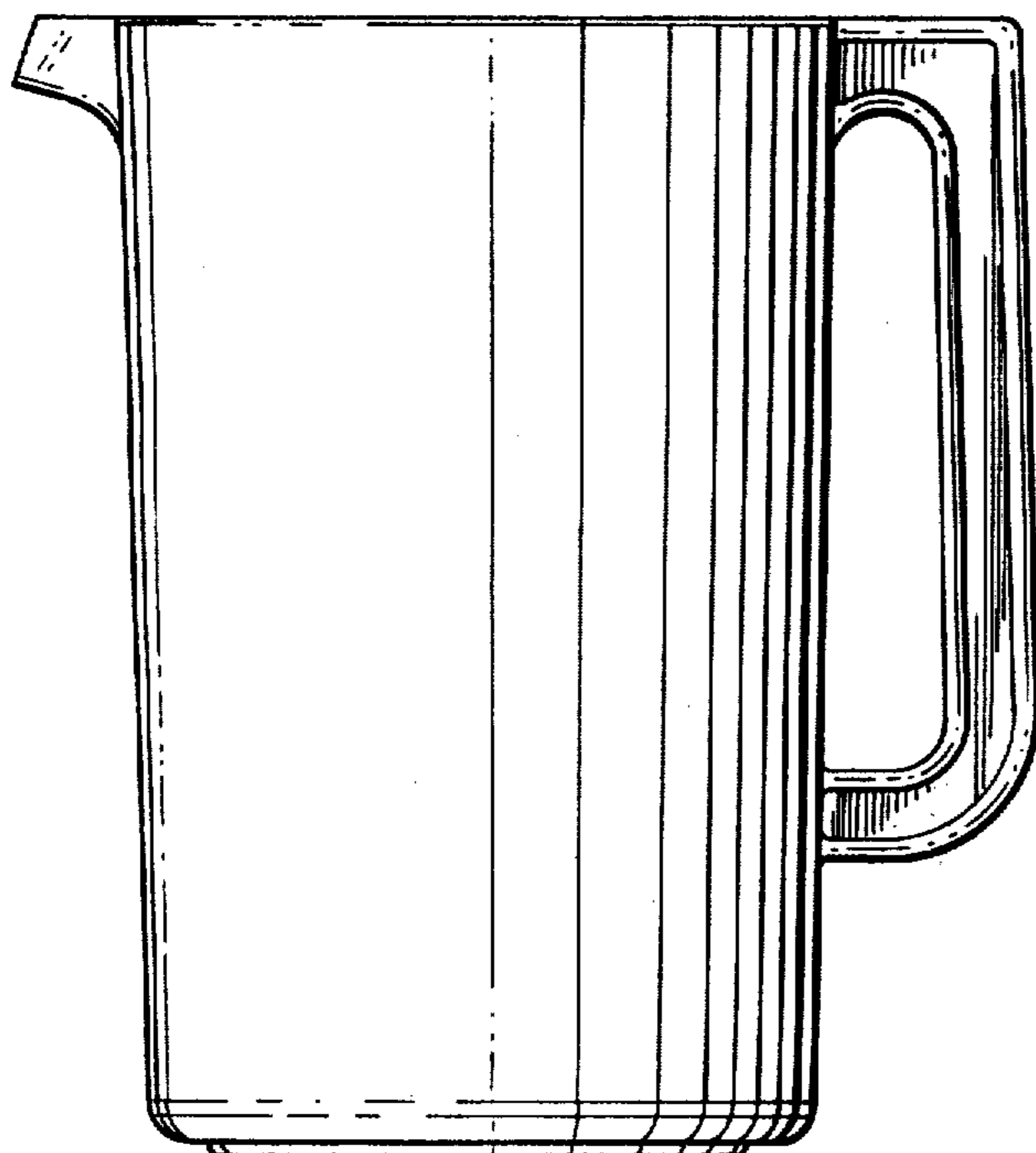

FIG. 8

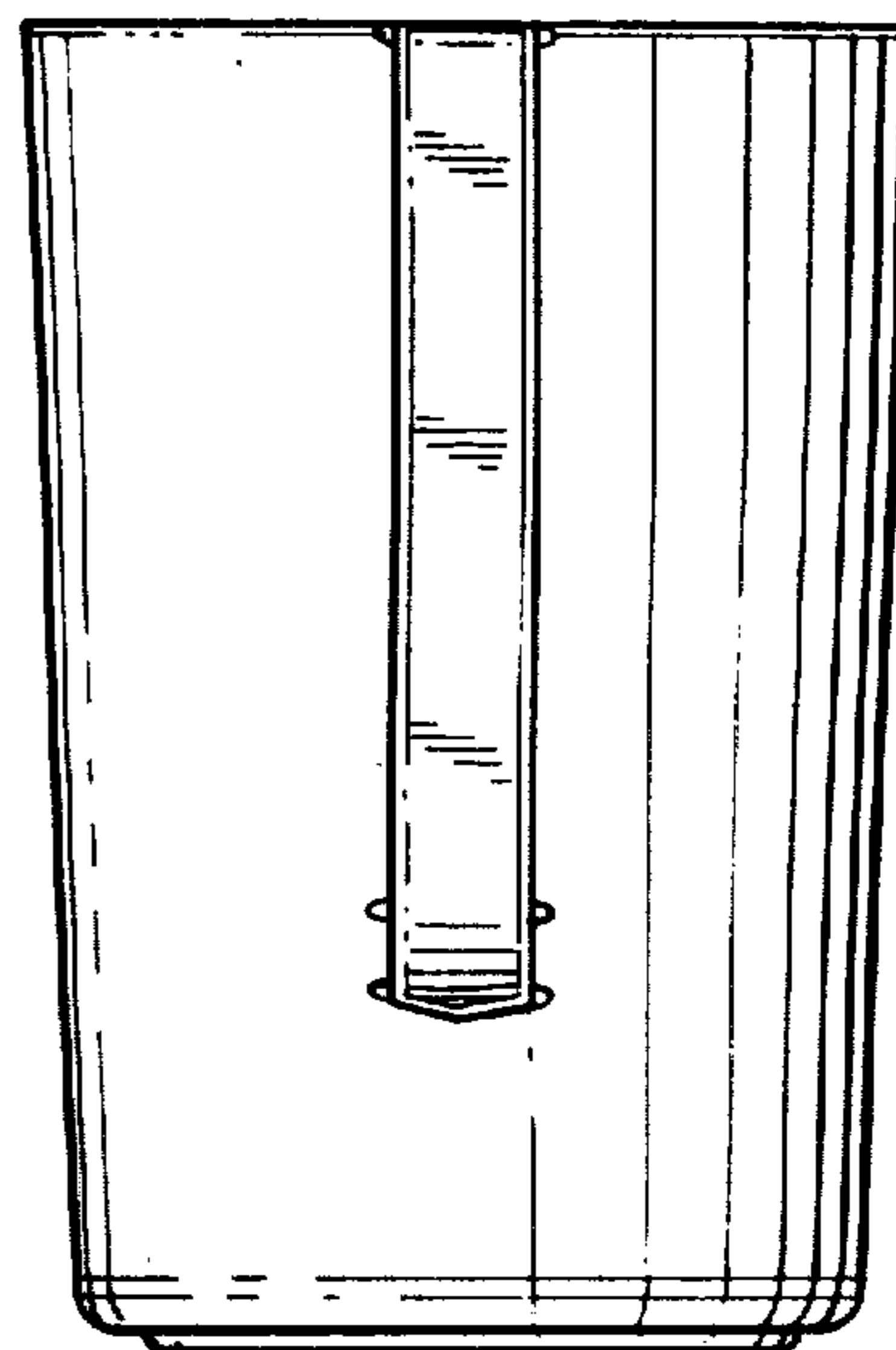

FIG. 10

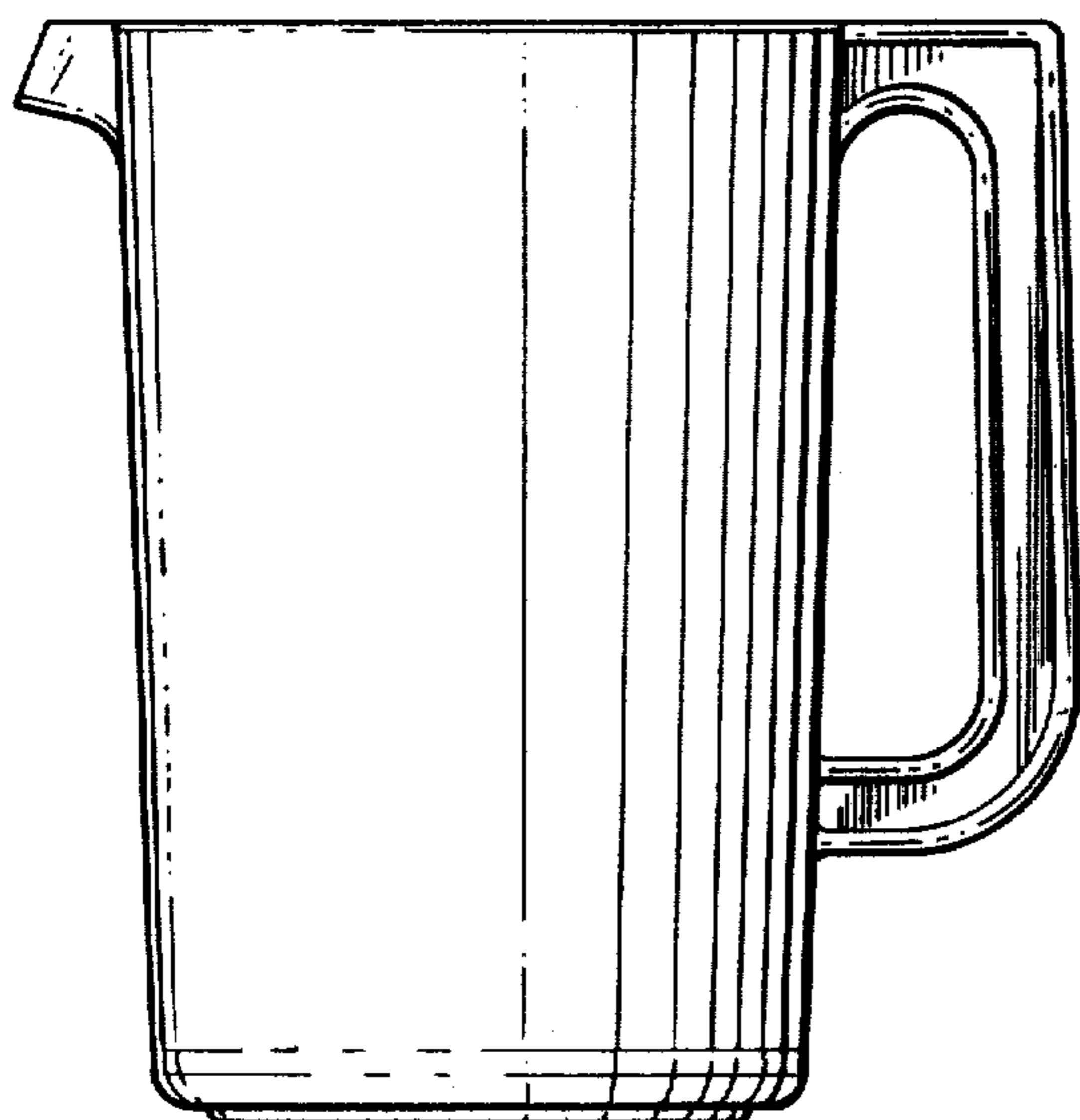

FIG. 14

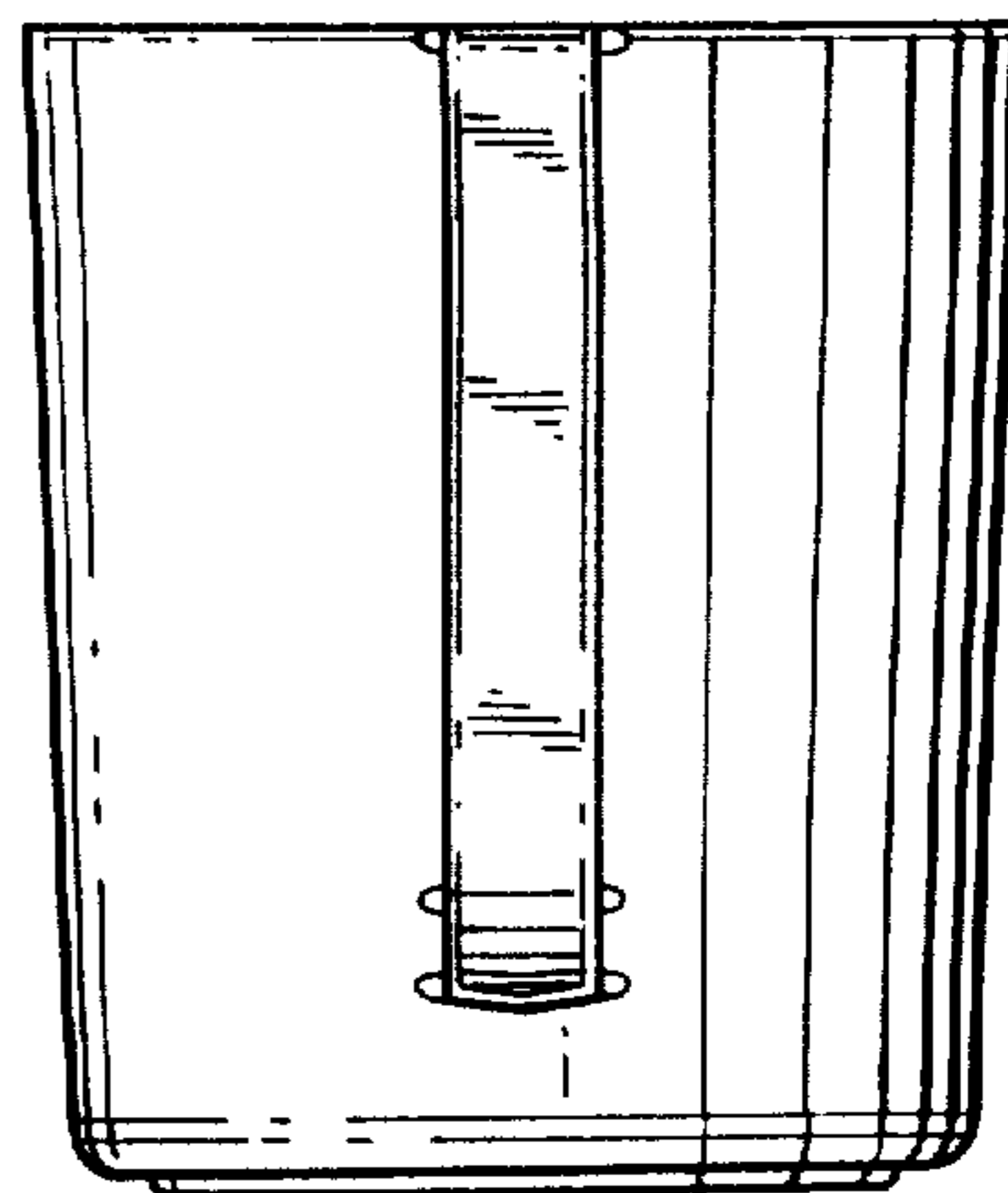

FIG. 15

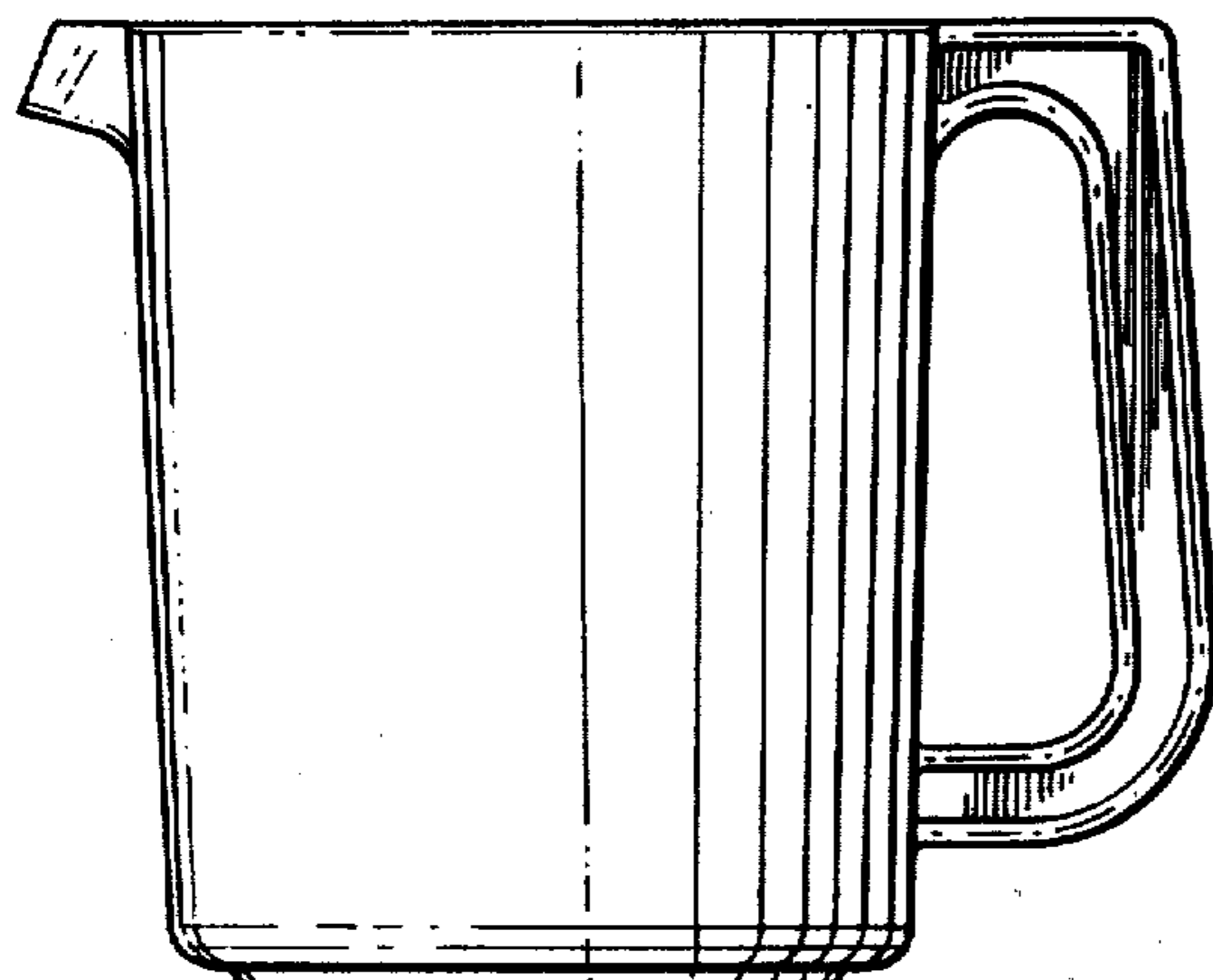

FIG. 9

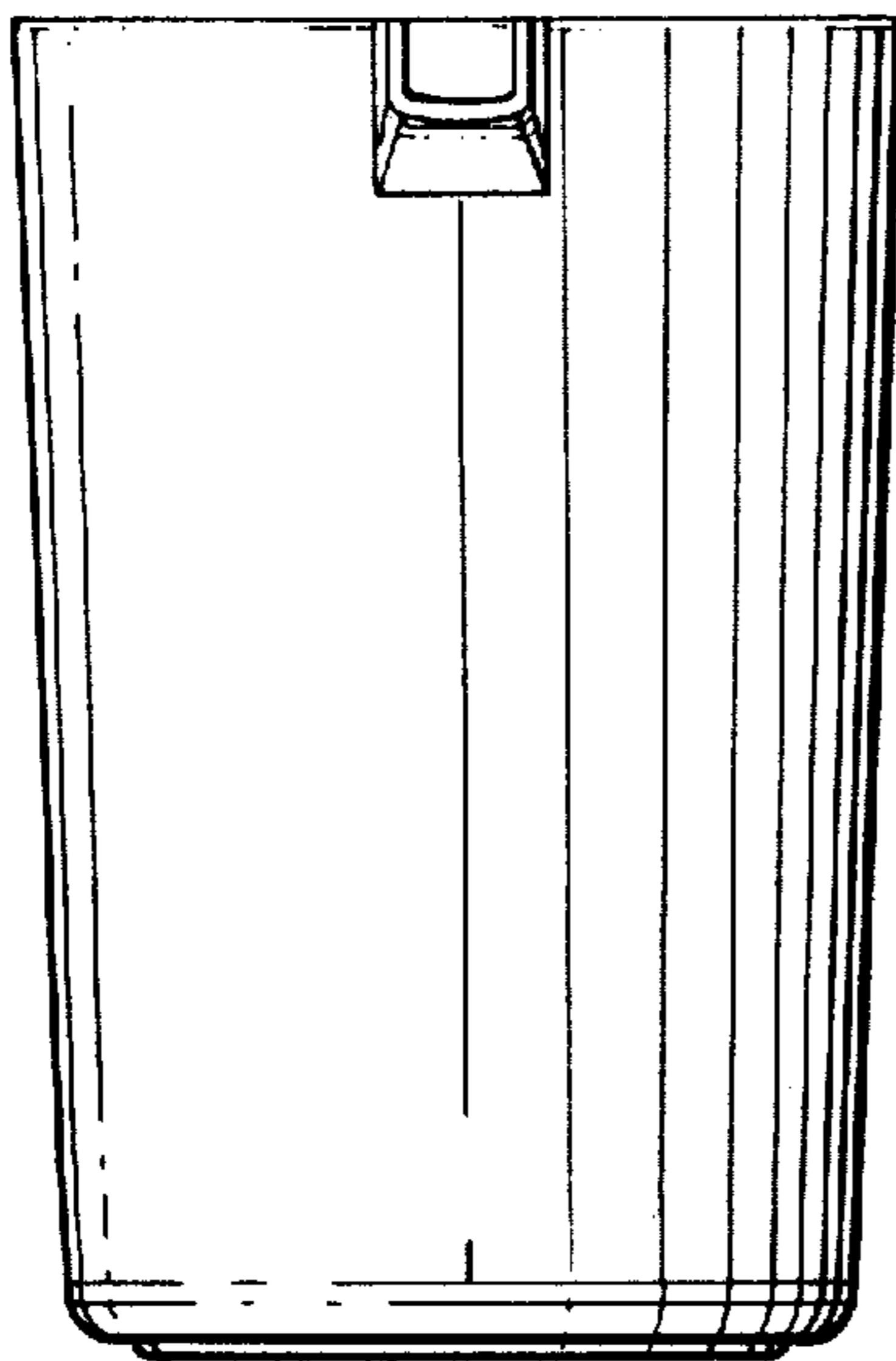

FIG. 11

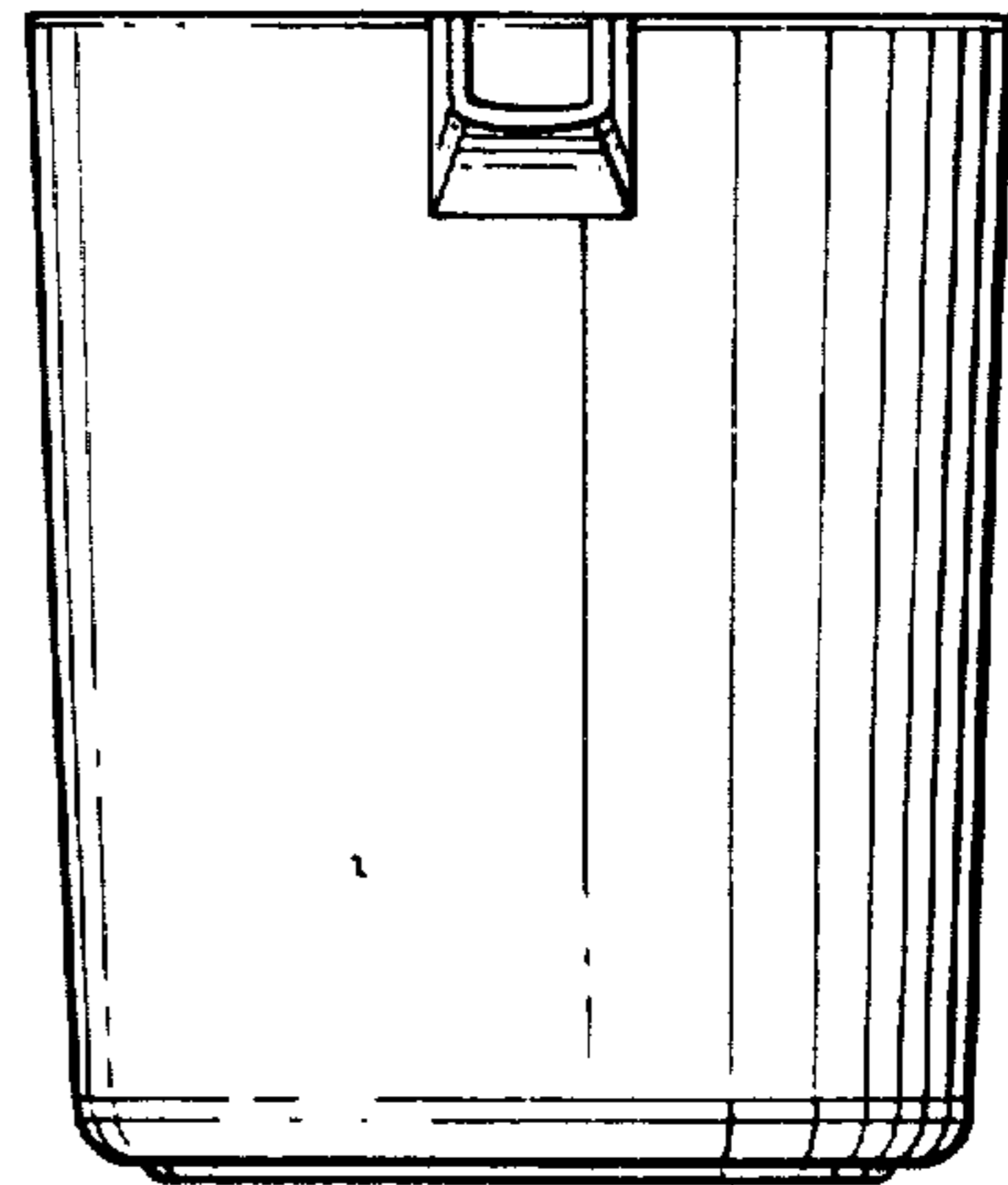

FIG. 16

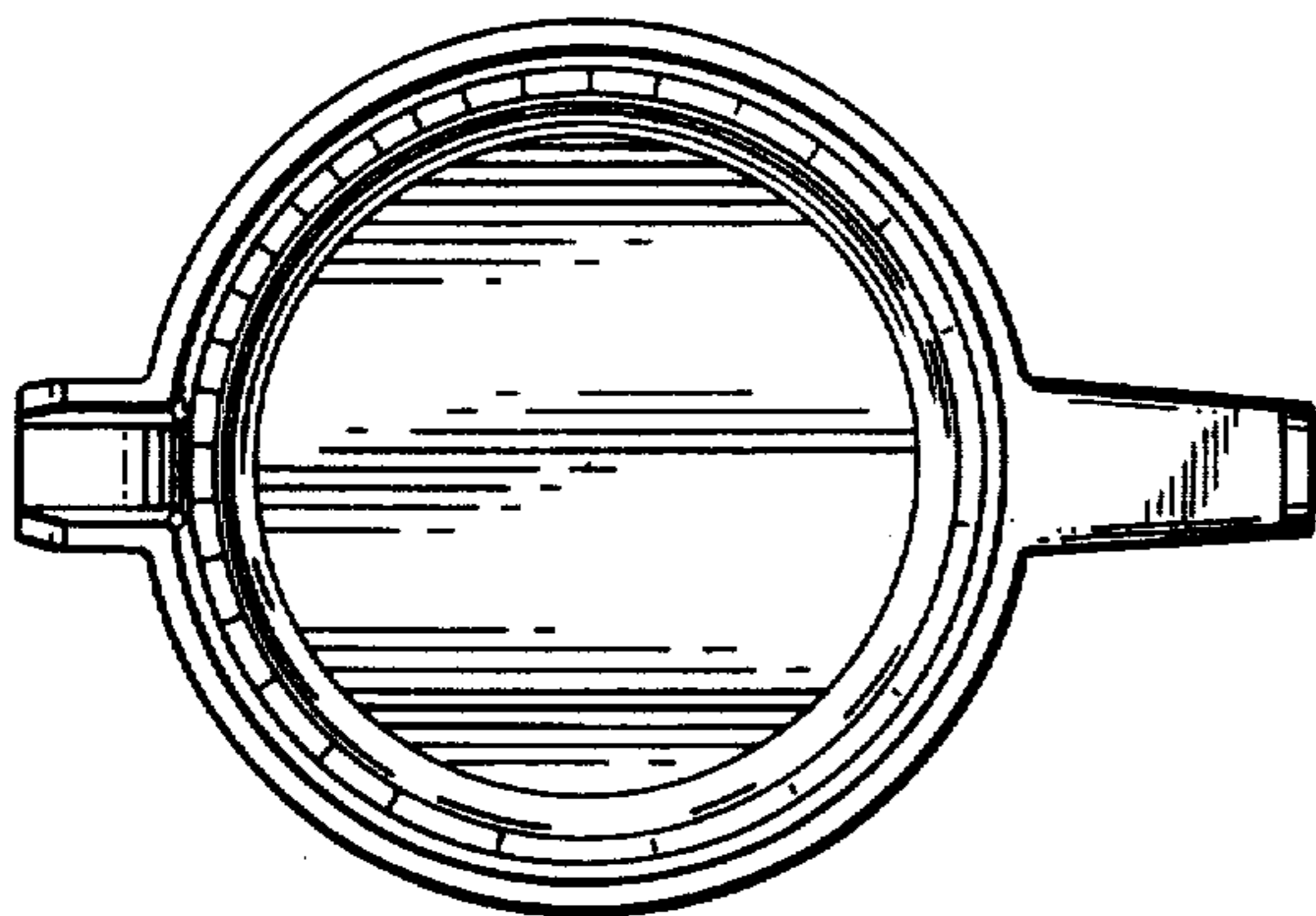

FIG. 12

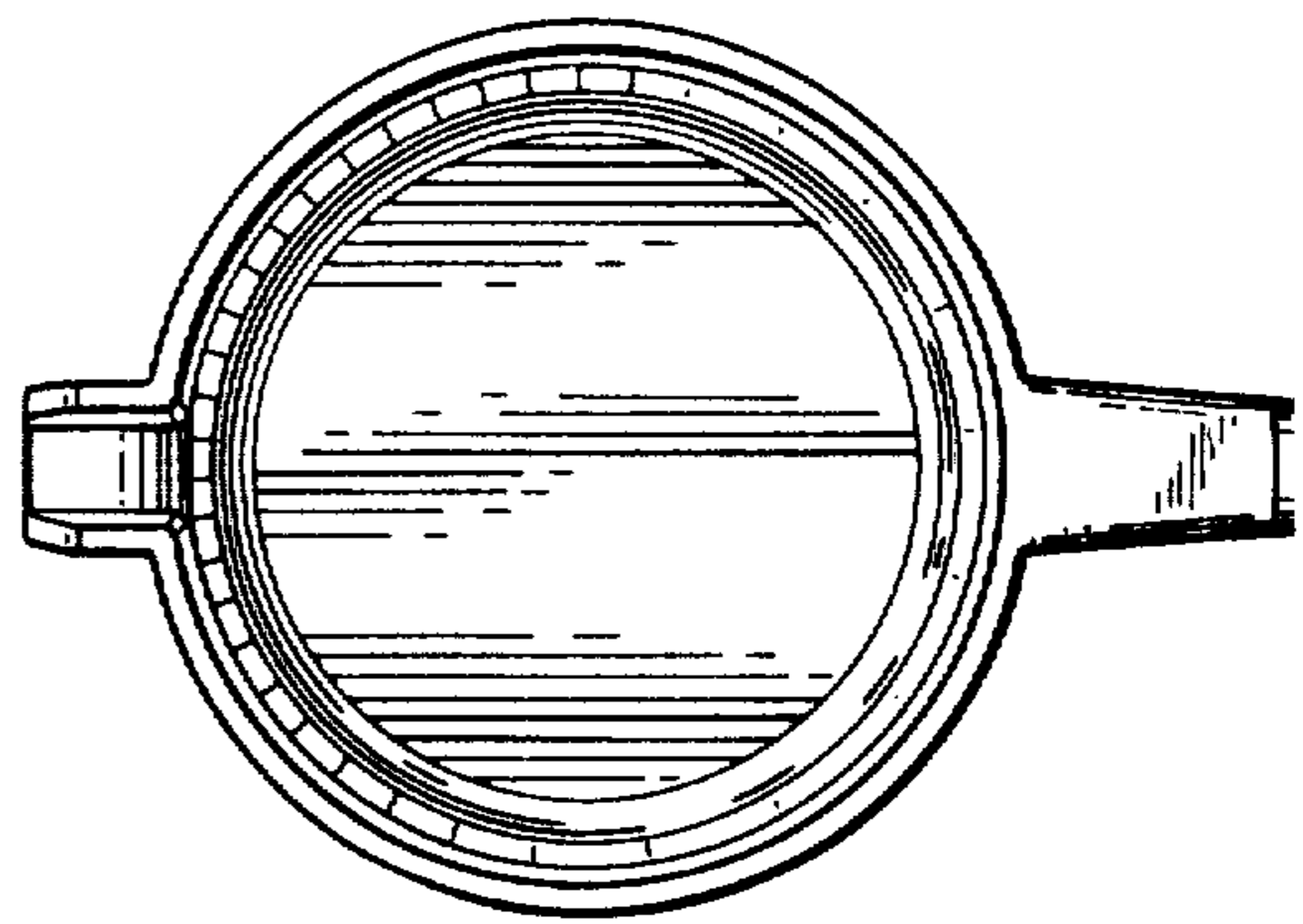

FIG. 17

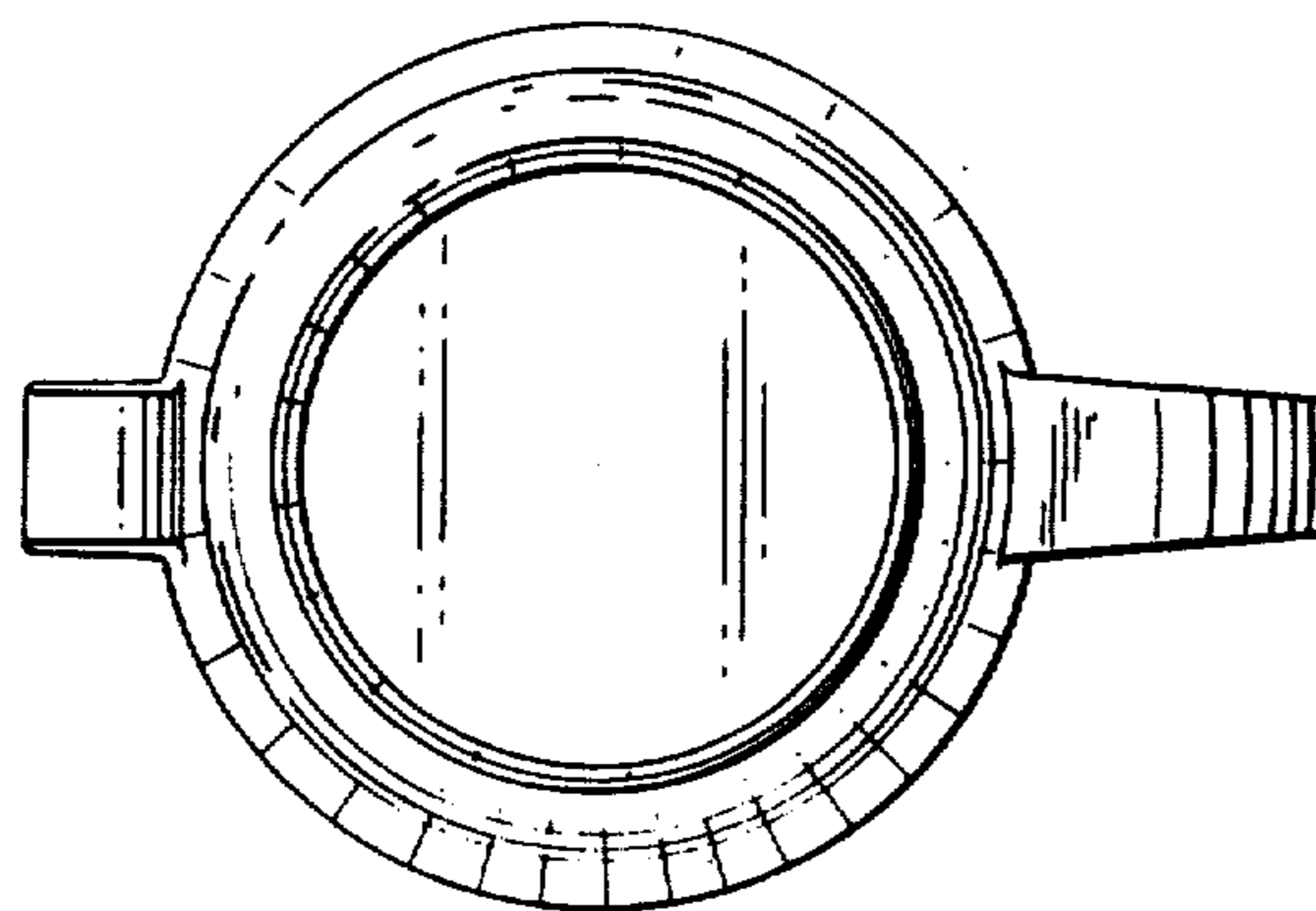

FIG. 13

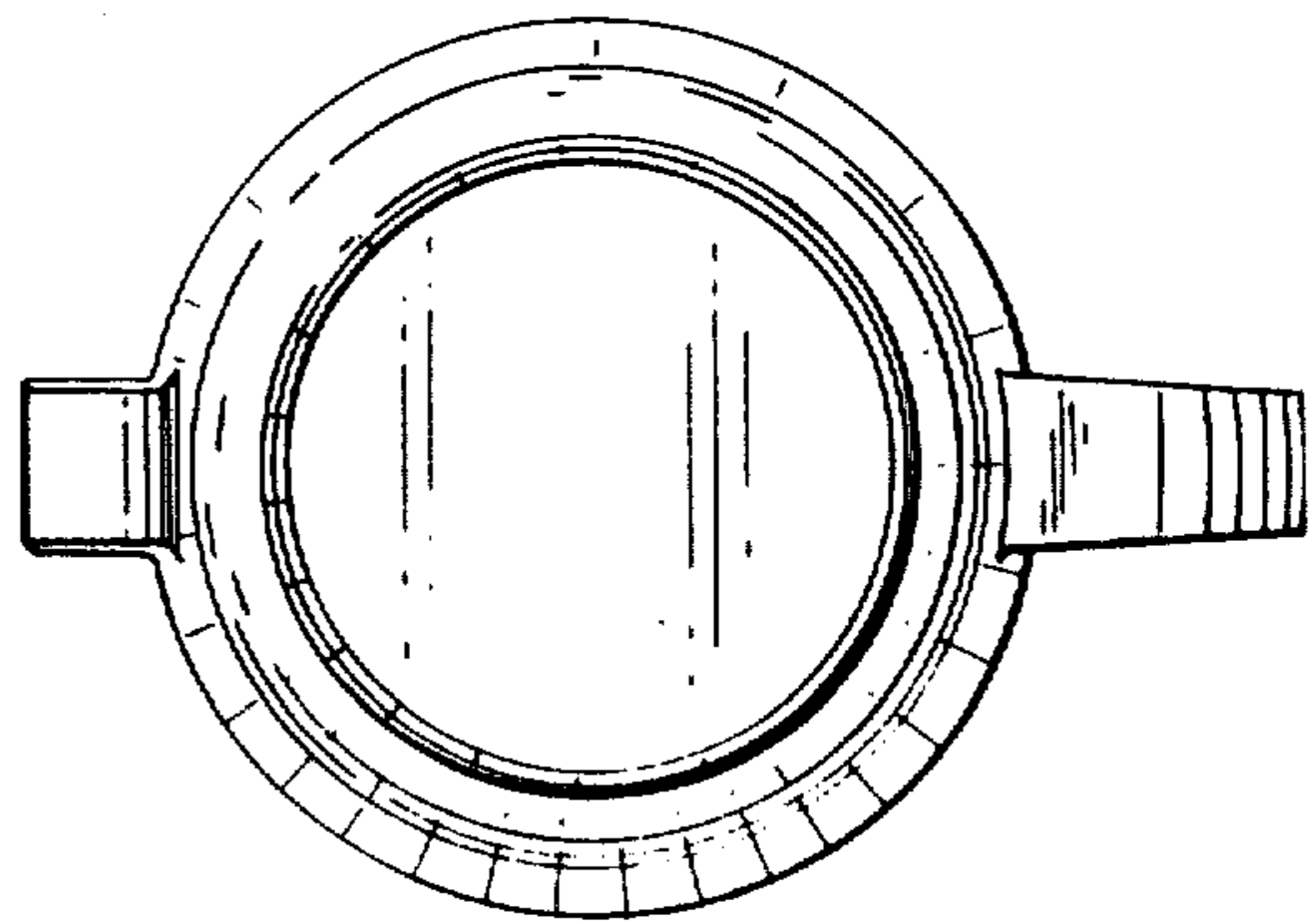

FIG. 18