

[54] **VACUUM CLEANER**

[75] Inventors: **Isao Ayukawa; Sachio Yamamoto; Akira Tsukada**, all of Osaka, Japan

[73] Assignee: **Sharp Corporation**, Osaka, Japan

[**] Term: 14 years

[21] Appl. No.: **319,027**

[22] Filed: **Jul. 27, 1981**

[30] **Foreign Application Priority Data**

Jan. 29, 1981 [JP] Japan 56-3292

[51] Int. Cl. **D15-05**

[52] U.S. Cl. **D32/21**

[58] Field of Search **D32/21; 15/327 R, 327 D, 15/327 E**

[56] **References Cited**

U.S. PATENT DOCUMENTS

- D. 259,882 7/1981 Yoshida et al. D32/21
- D. 261,266 10/1981 Yoshida et al. D32/21
- D. 261,267 10/1981 Hug D32/21

OTHER PUBLICATIONS

Electrical Merchandising Week, Jan. 4, 1963, p. 21 Eureka "Princess II".

Merchandising Week, Jun. 6, 1966, p. 36 First Power Vacuum Cleaner.

Primary Examiner—Wallace R. Burke

Assistant Examiner—Lynn Wilder

Attorney, Agent, or Firm—Flehr, Hohbach, Test, Albritton & Herbert

[57] **CLAIM**

The ornamental design for a vacuum cleaner, as shown and described.

DESCRIPTION

FIG. 1 is a perspective view of the vacuum cleaner showing our new design;

FIG. 2 is a perspective view of the vacuum cleaner with the dust box removed;

FIG. 3 is a bottom view thereof;

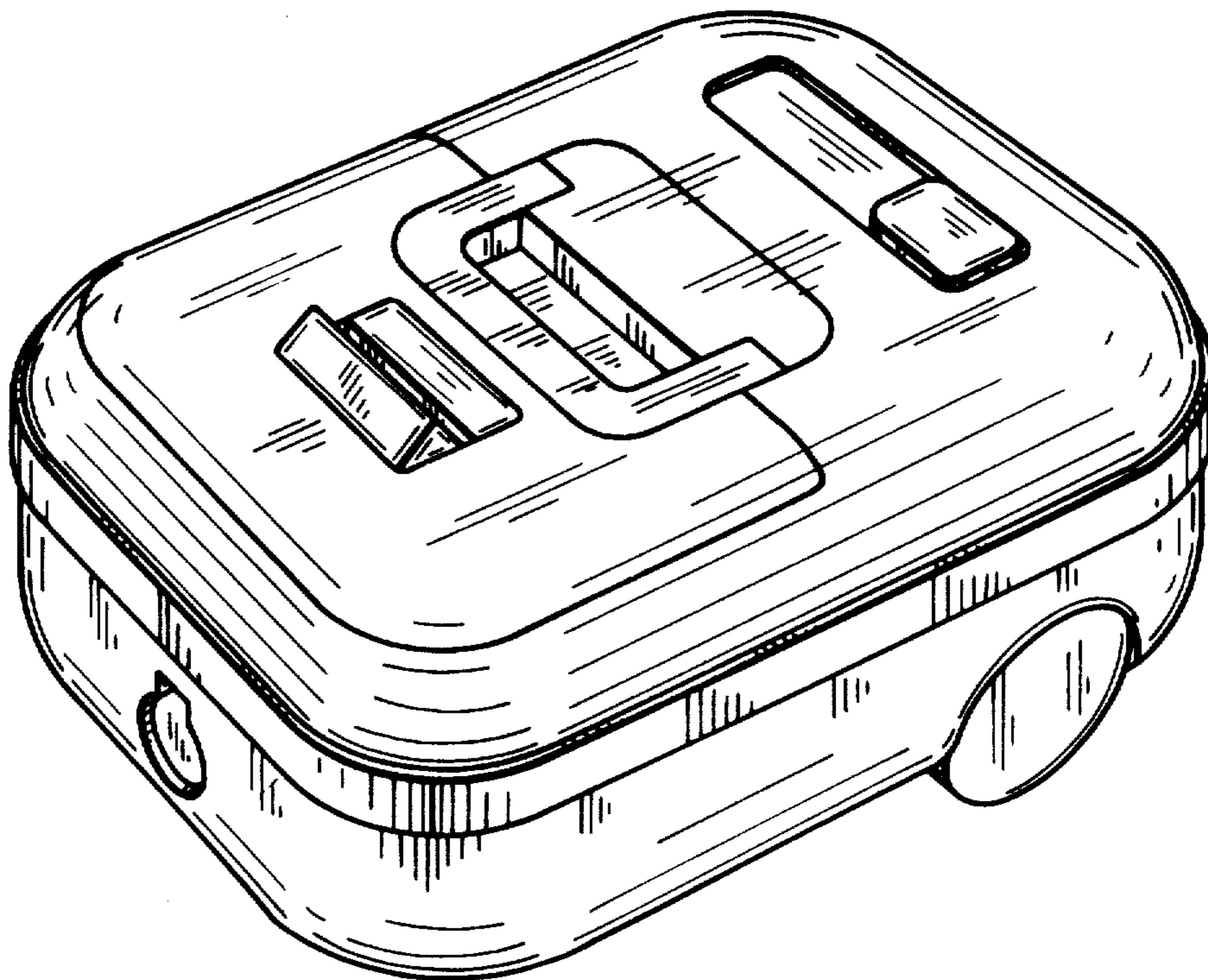
FIG. 4 is a top view thereof;

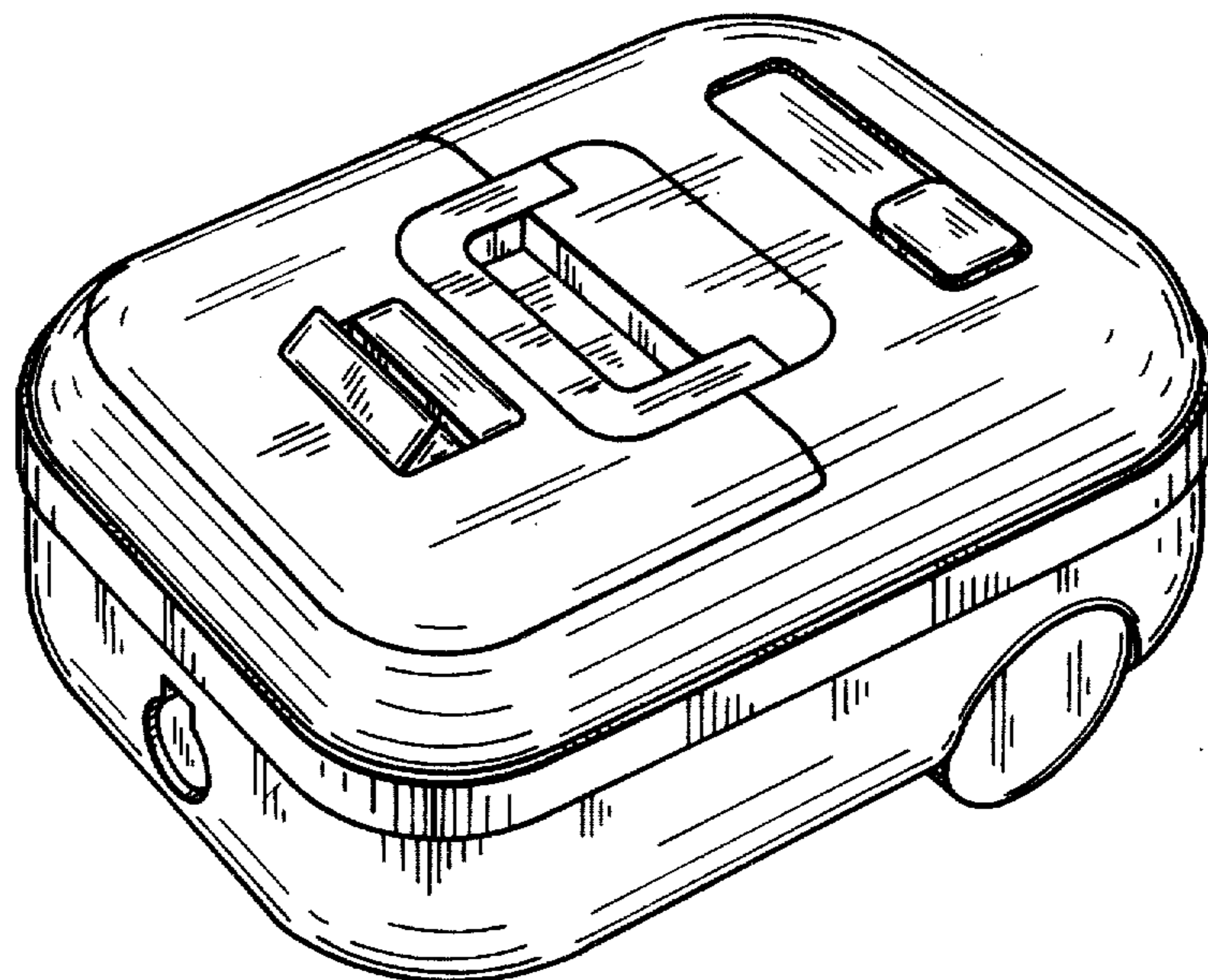
FIG. 5 is a left side elevational view thereof;

FIG. 6 is a right side elevational view thereof;

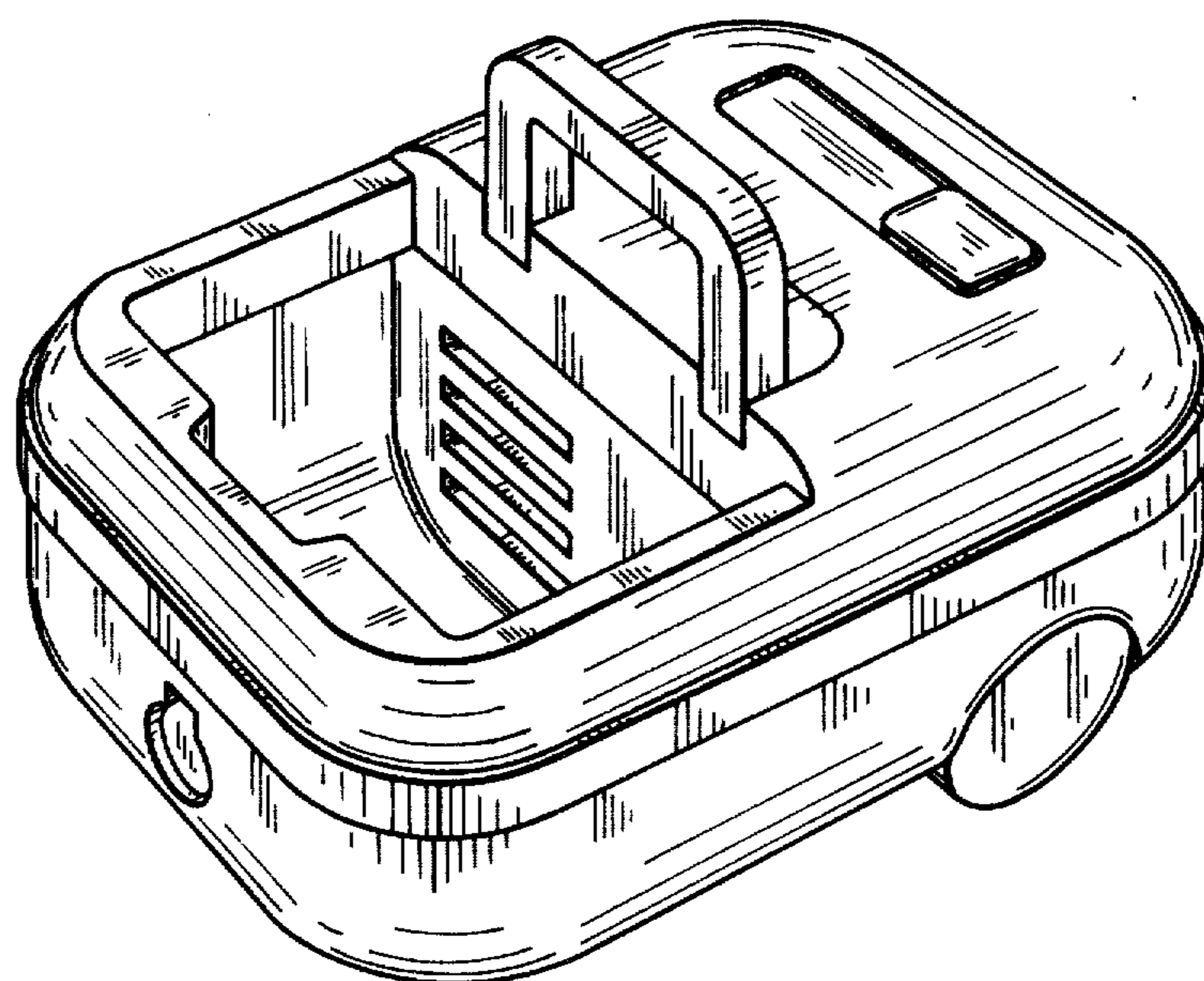
FIG. 7 is a rear view thereof; and

FIG. 8 is a front view thereof.

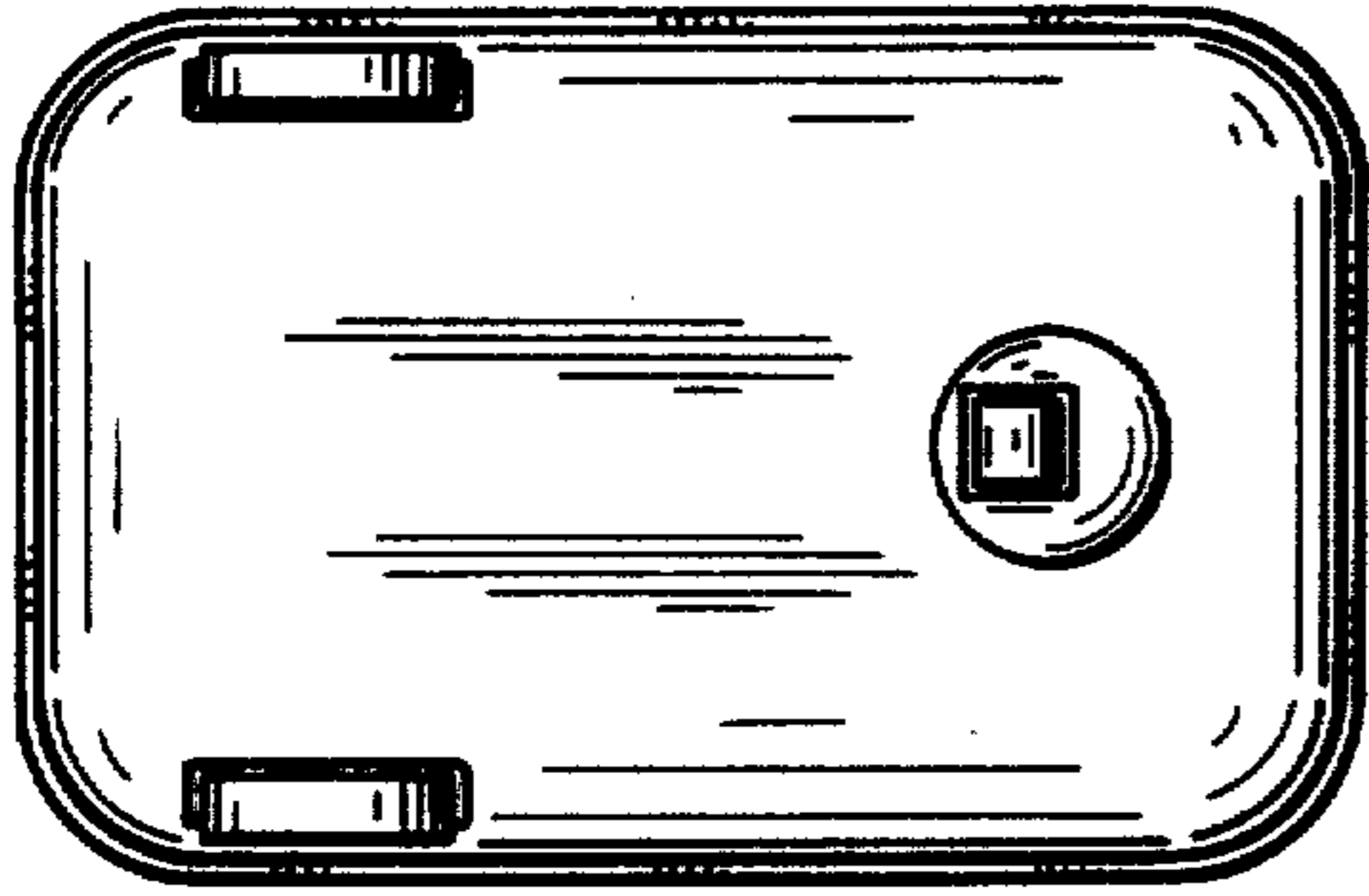




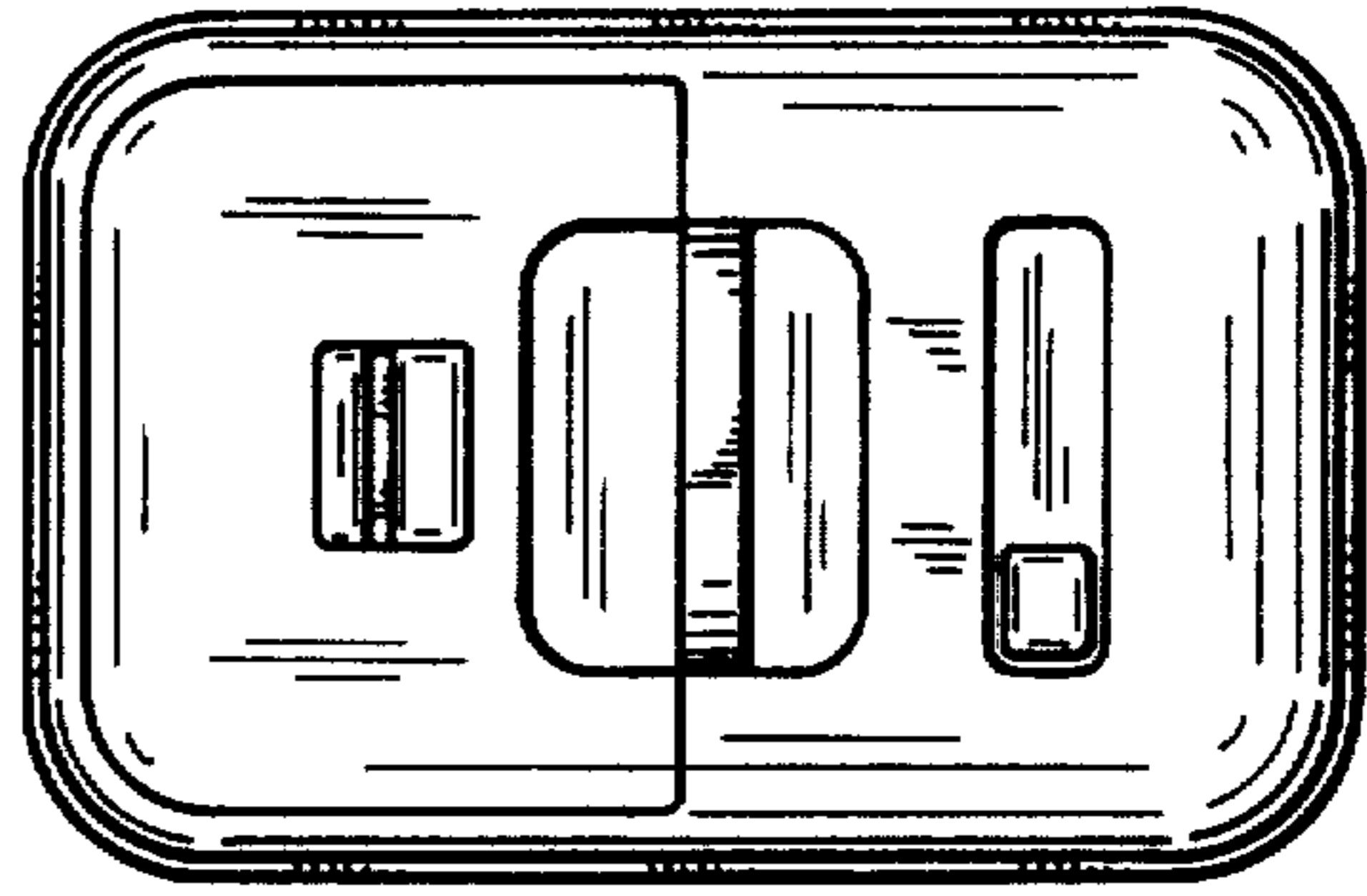
FIG_1



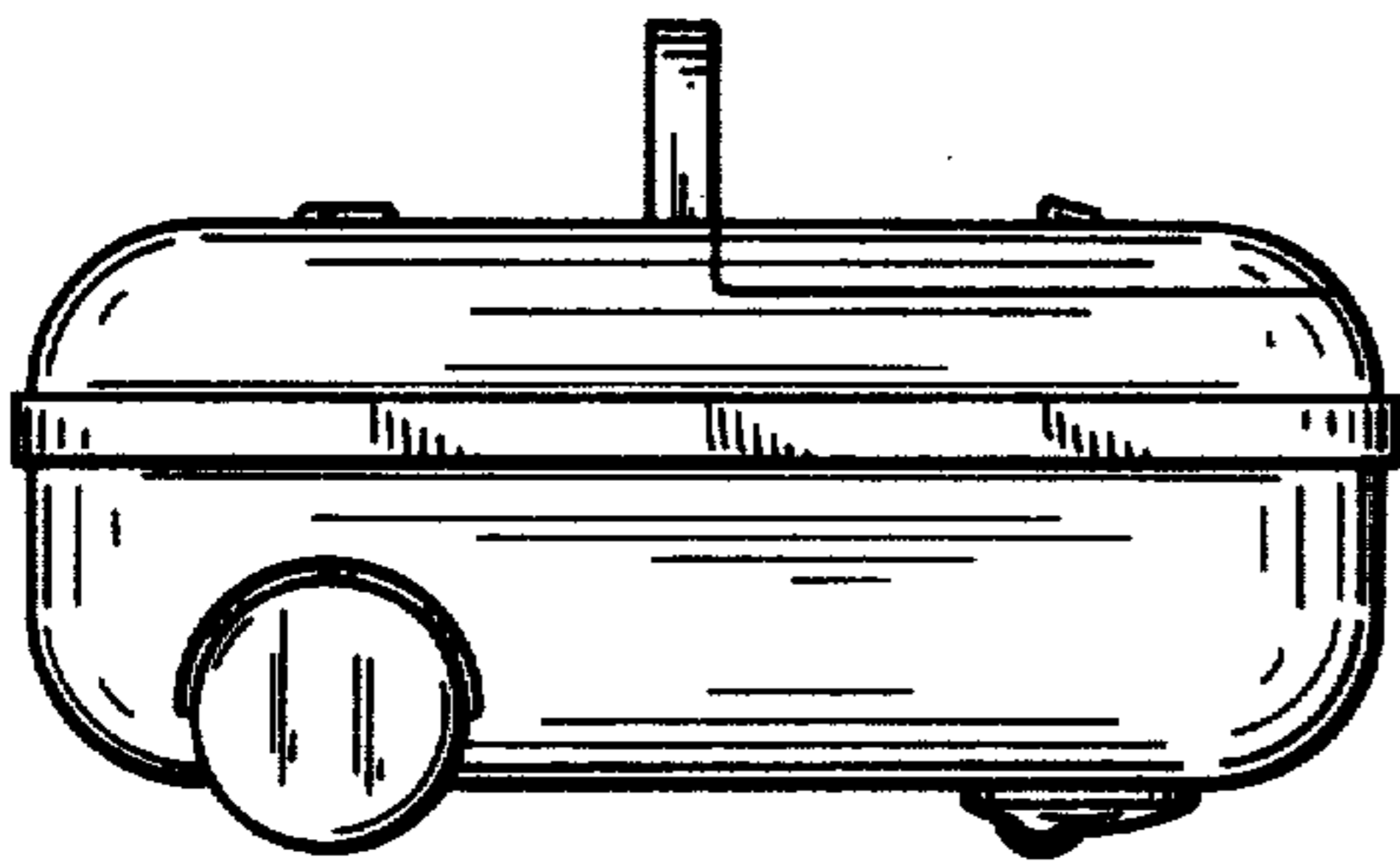
FIG_2



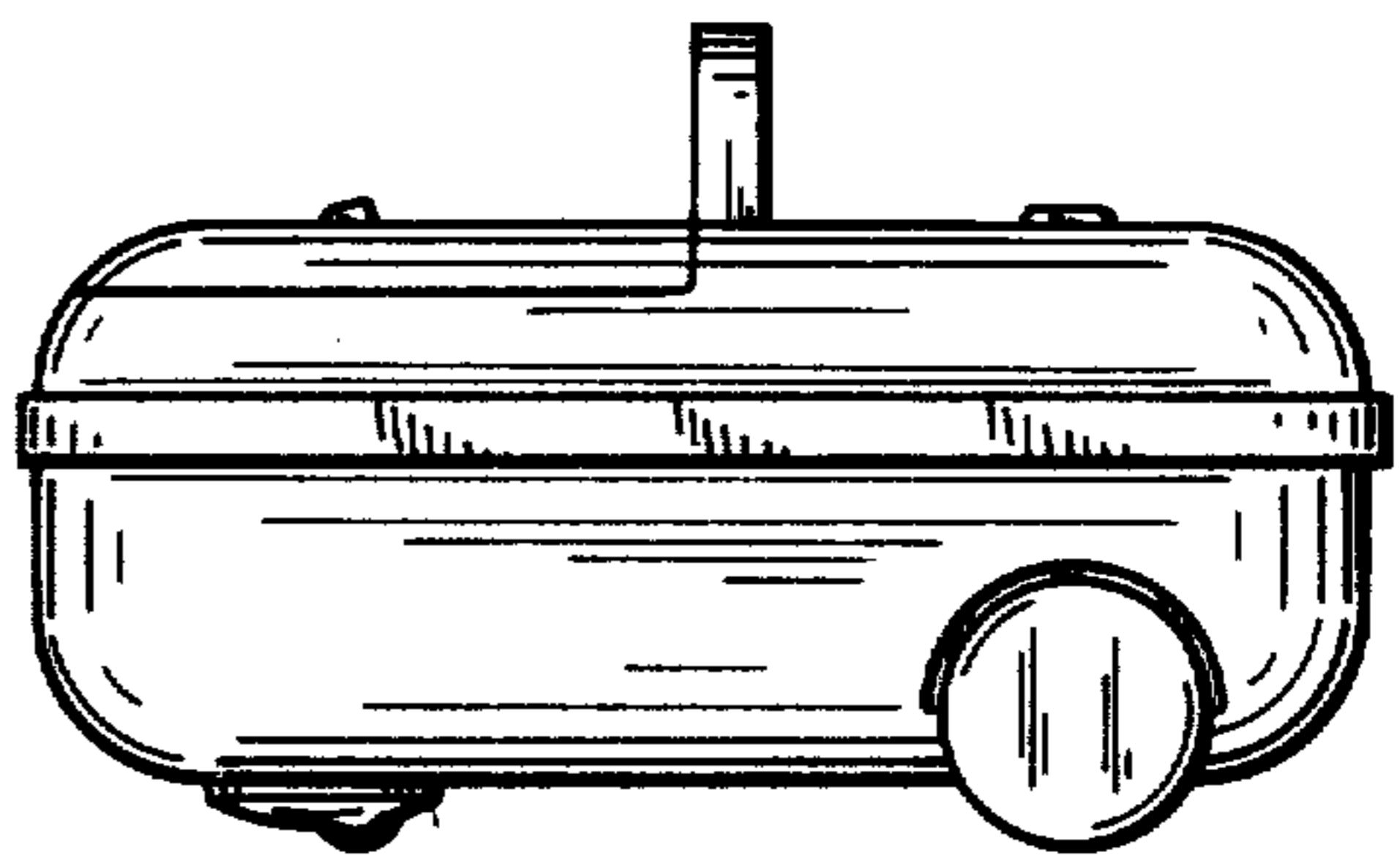
FIG_3



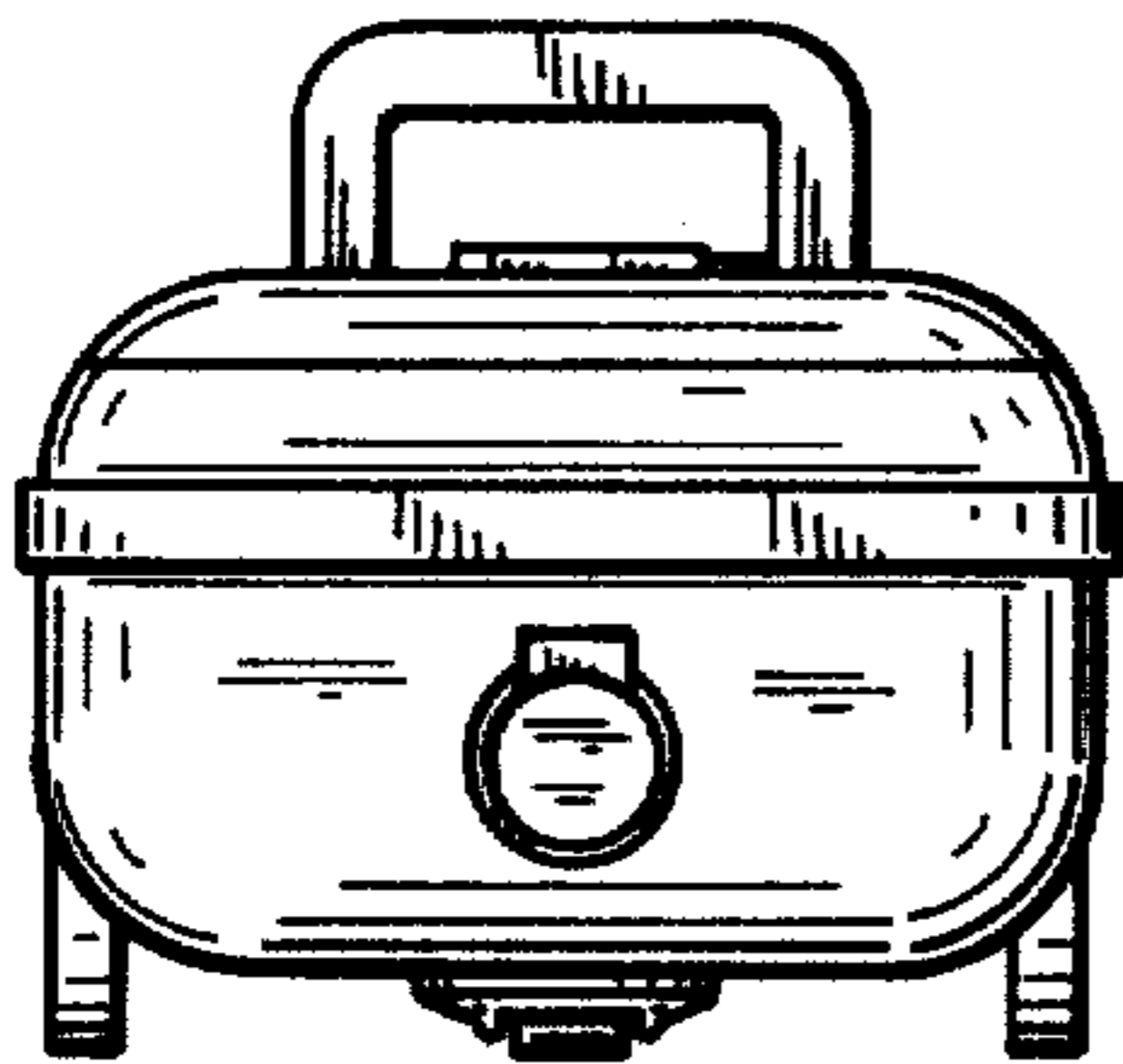
FIG_4



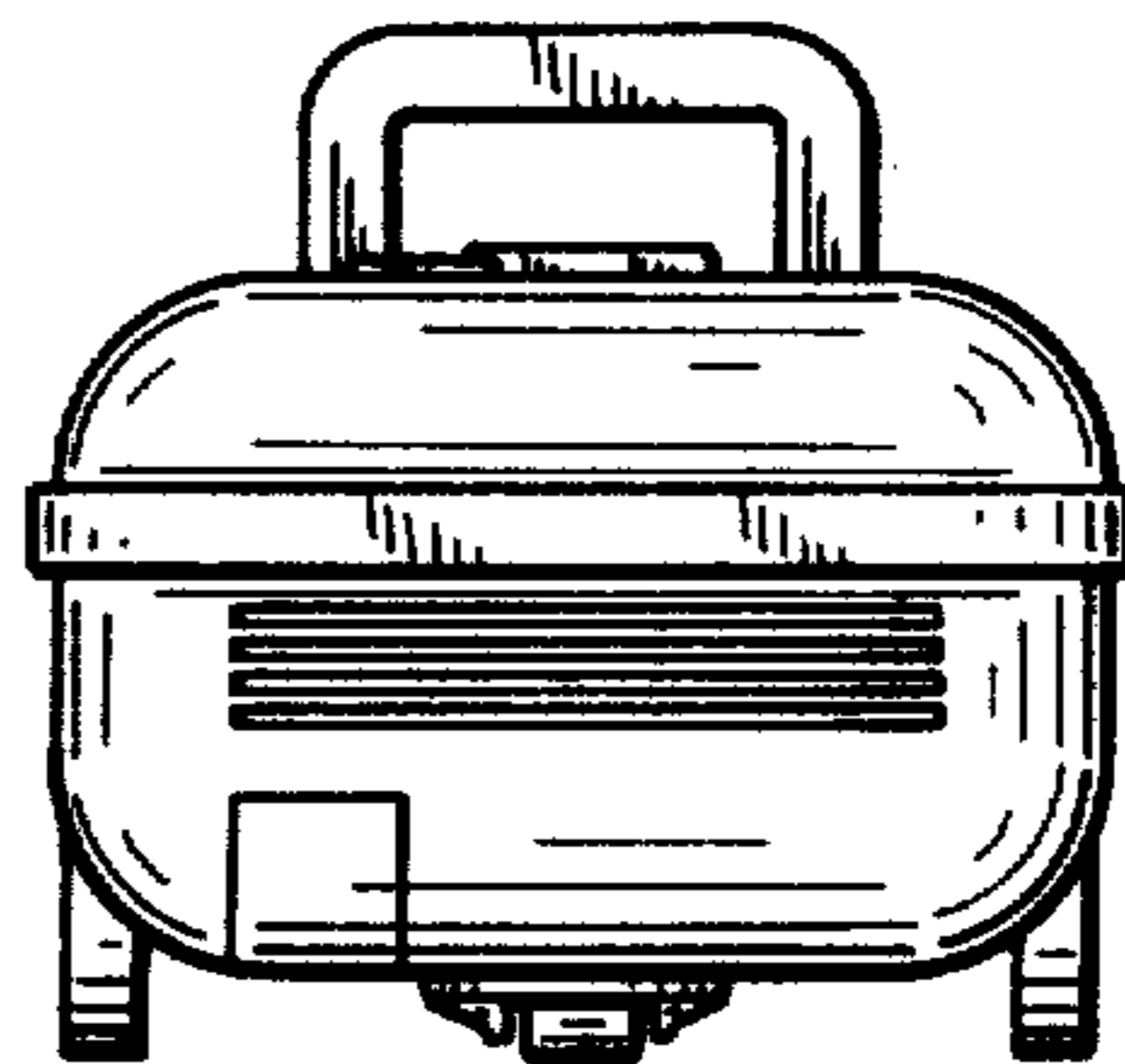
FIG_5



FIG_6



FIG_7



FIG_8