

[54] KIOSK FOR AUTOMATIC BANKING OR THE LIKE

[75] Inventors: **Randall L. Elliott; James A. Pickel,** both of Oklahoma City, Okla.

[73] Assignee: **Liberty National Bank & Trust Co.,** Oklahoma City, Okla.

[**] Term: **14 Years**

[21] Appl. No.: **297,144**

[22] Filed: **Aug. 28, 1981**

[51] Int. Cl. **D99-00**

[52] U.S. Cl. **D99/28**

[58] Field of Search **D99/28, 34, 99, 43; 109/10, 11, 12, 21, 1; 232/1 R, 1 E, 51; D25/1, 35, 16; 312/100, 211, 212**

[56] **References Cited**

U.S. PATENT DOCUMENTS

- D. 231,692 5/1974 Dattner D25/1
- D. 236,635 9/1975 Friedman D99/28

4,121,523 10/1978 Hastings 109/11

FOREIGN PATENT DOCUMENTS

86892 2/1956 Norway 312/100

Primary Examiner—Charles A. Rademaker
Attorney, Agent, or Firm—Robert M. Hessin

[57] **CLAIM**

The ornamental design for a kiosk for automatic banking or the like, substantially as shown and described.

DESCRIPTION

FIG. 1 is a side elevational view of the kiosk for automatic banking or the like;
 FIG. 2 is a front elevational view thereof;
 FIG. 3 is a top plan view thereof;
 FIG. 4 is a bottom plan view thereof;
 FIG. 5 is a side elevational view of the side opposite that shown in FIG. 1;
 FIG. 6 is a rear elevational view thereof; and
 FIG. 7 is a sectional view of the novel design as taken along lines 7—7 of FIG. 6.

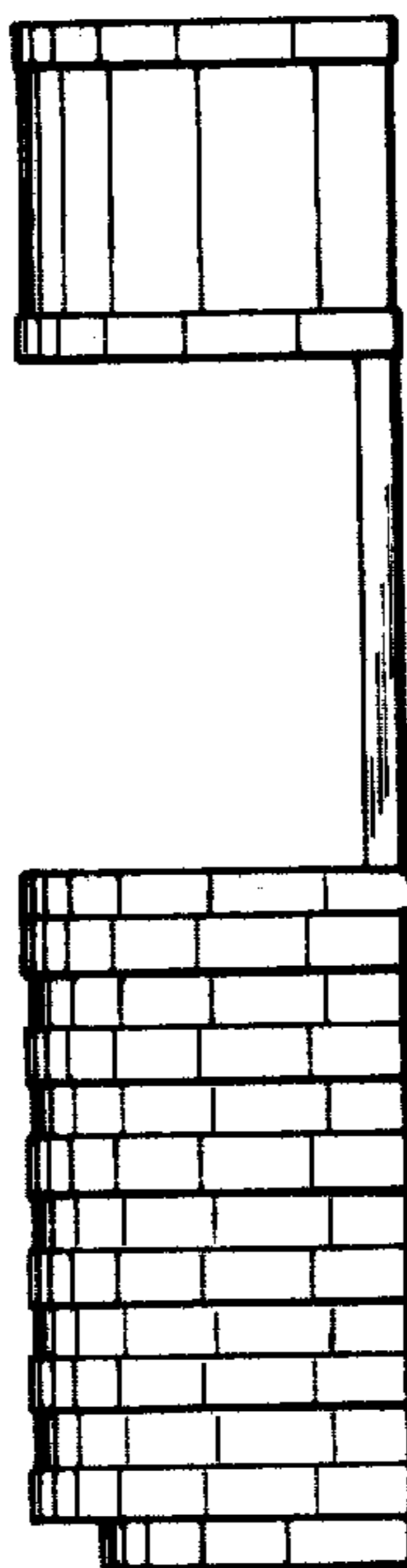

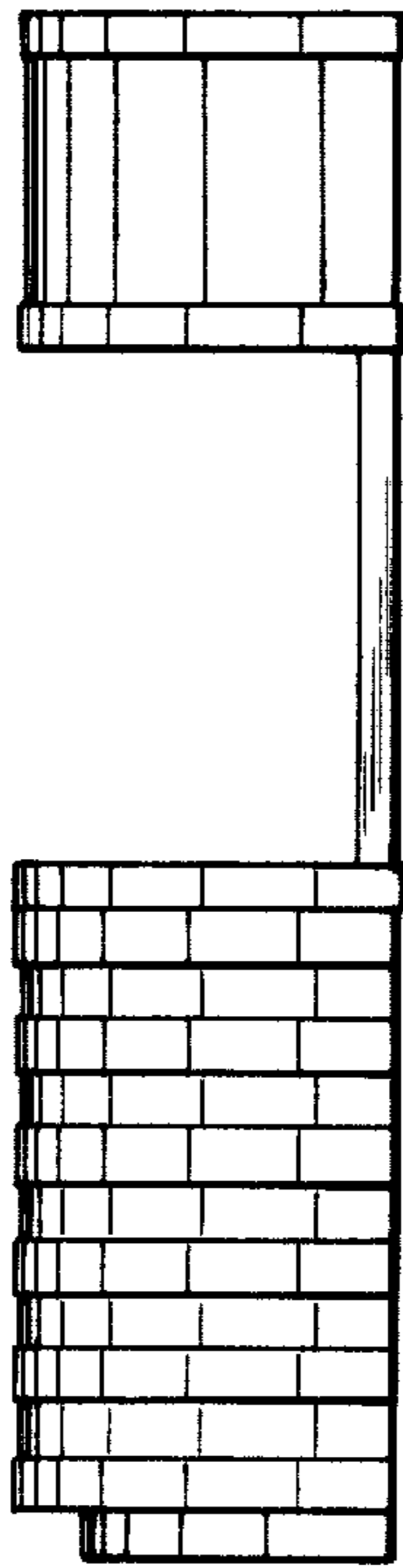

FIG. 1

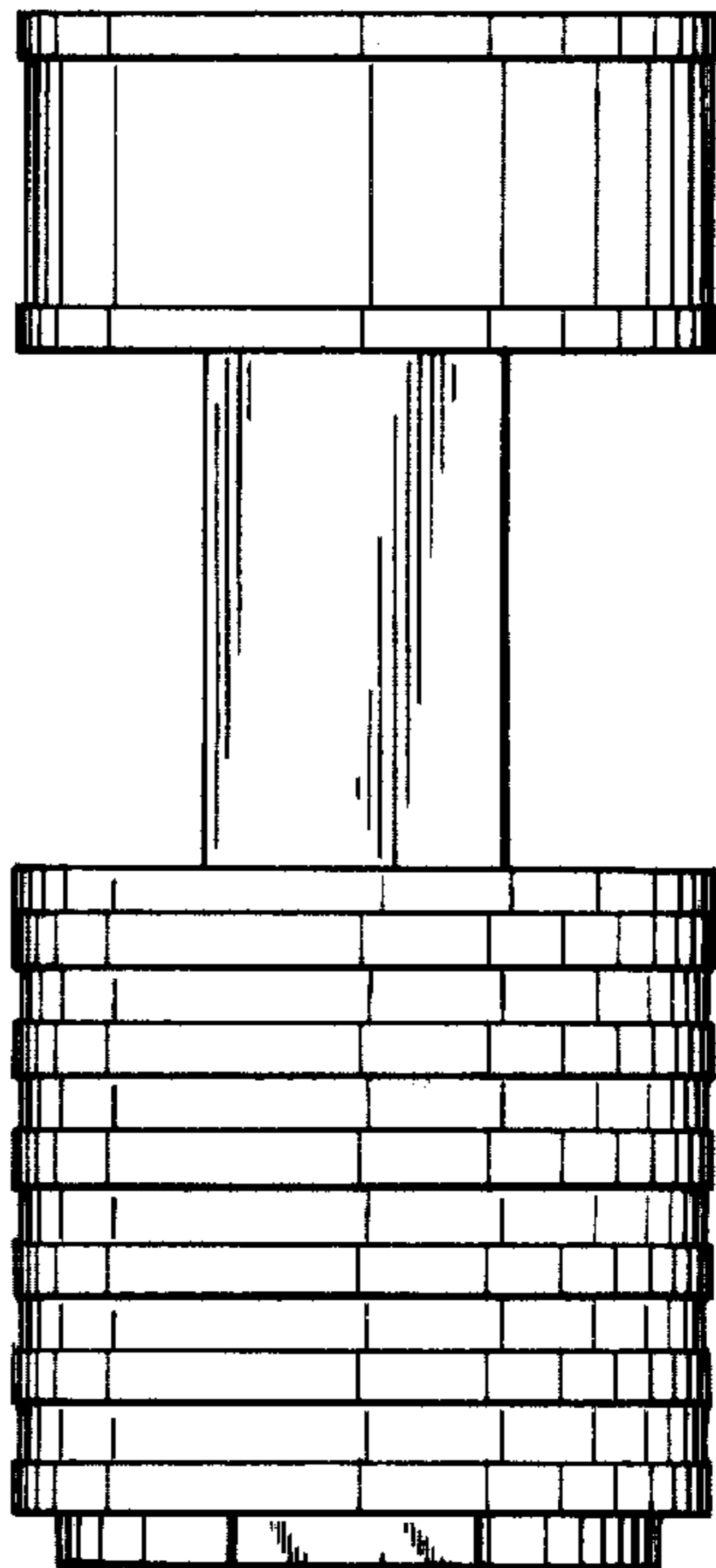

FIG. 2

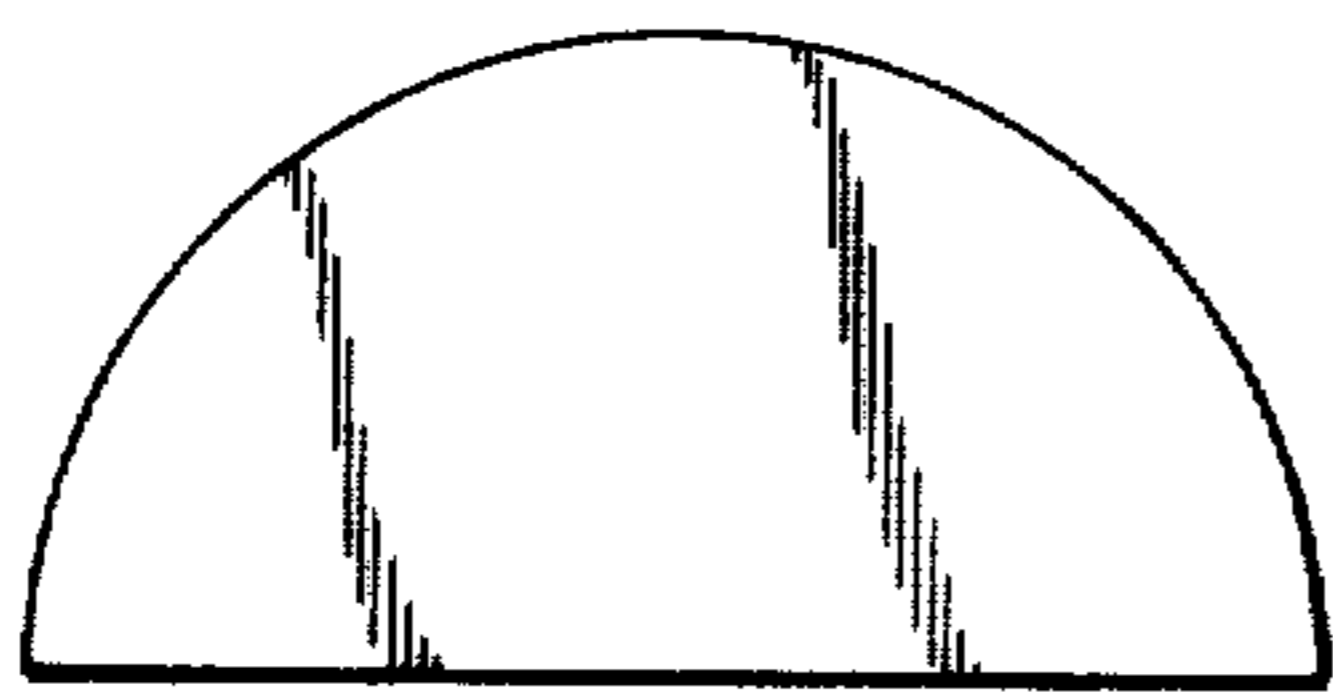

FIG. 3

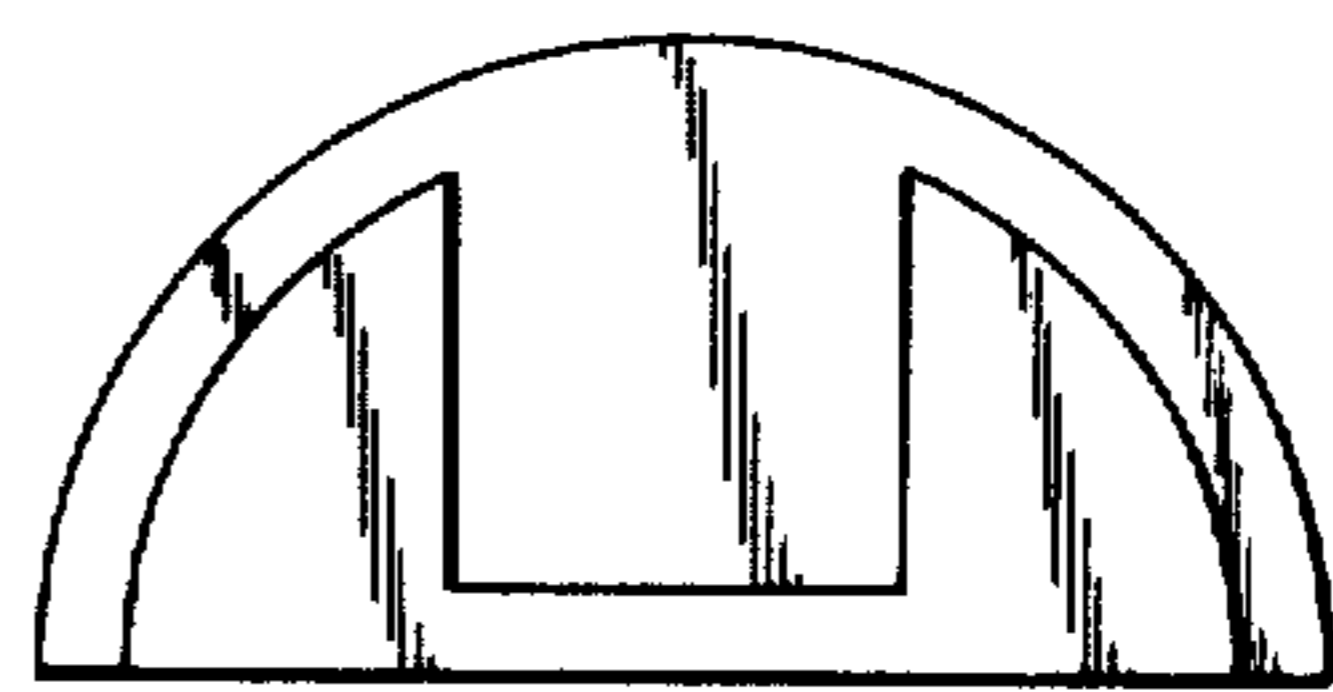

FIG. 4

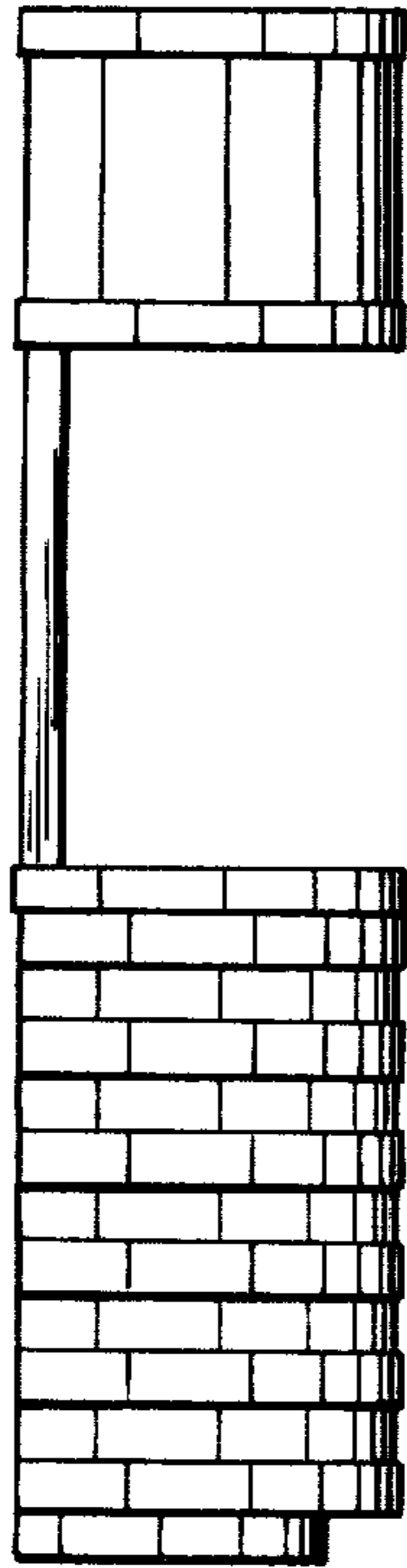

FIG. 5

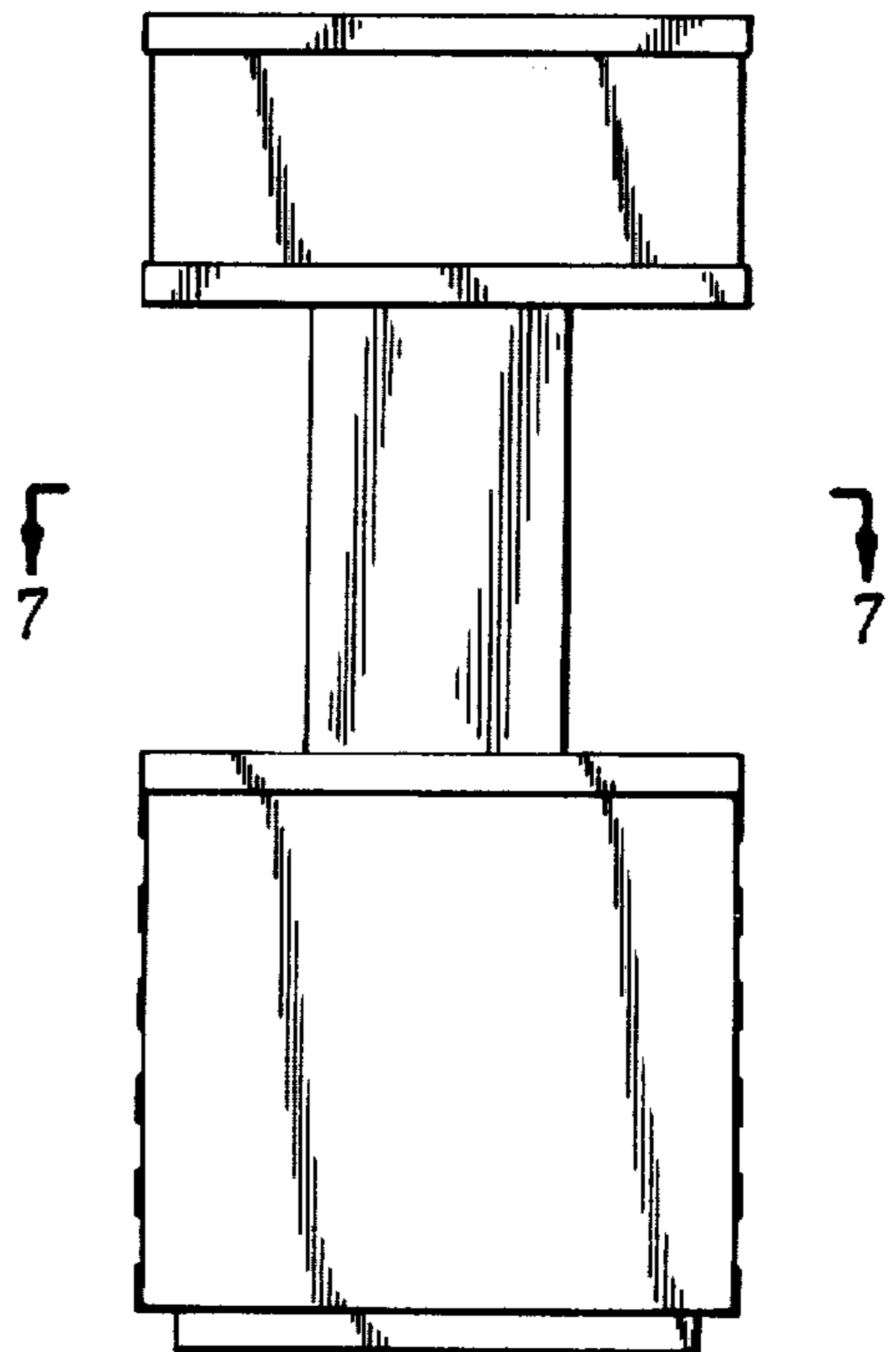

FIG. 6

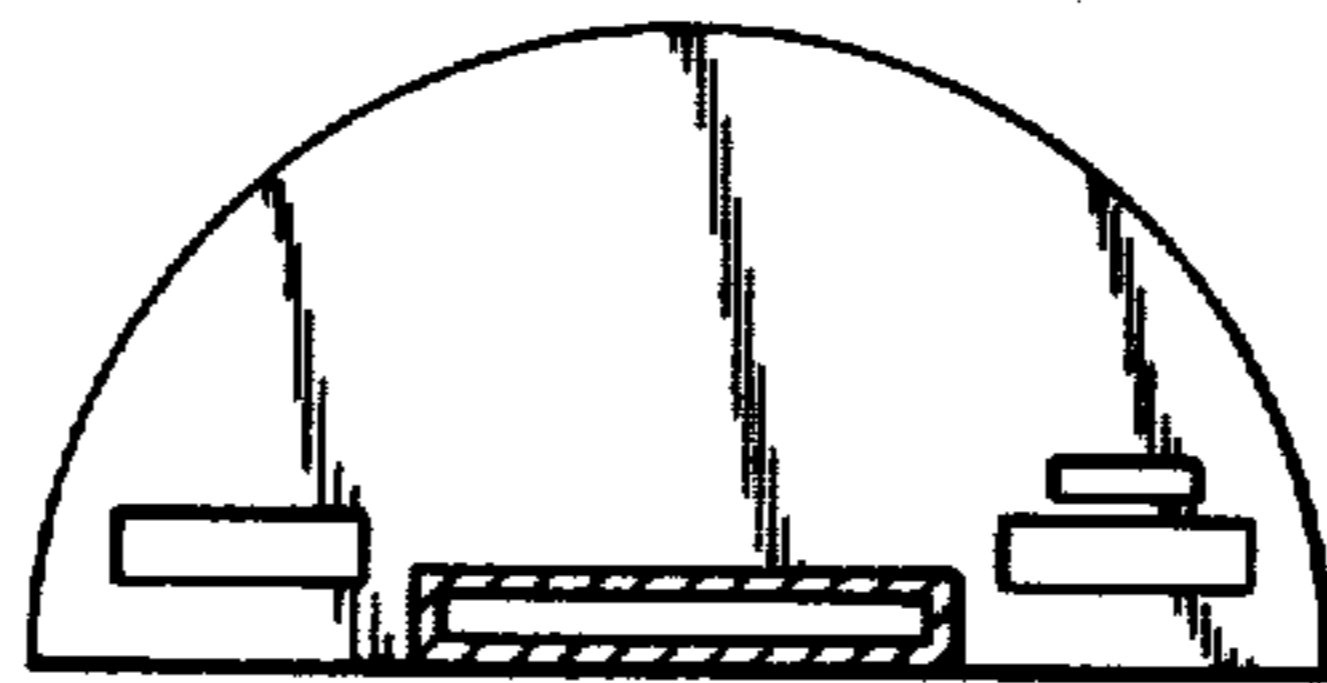

FIG. 7