

[54] TELEPHONE

[75] Inventor: Y. Shimizu, Ichihara, Japan

[73] Assignee: Arrow Trading Co., Inc., New York, N.Y.

[**] Term: 14 Years

[21] Appl. No.: 415,578

[22] Filed: Sep. 7, 1982

[51] Int. Cl. D14-03

[52] U.S. Cl. D14/56; D14/53

[58] Field of Search D14/53, 60, 56, 52; 179/100 R, 100 D, 100 C, 178, 179, 103, 2 TC

[56] References Cited

U.S. PATENT DOCUMENTS

D. 252,929	9/1979	Genaro et al.	D14/60
D. 259,043	4/1981	Feinberg	D14/53
D. 259,563	6/1981	Marshall	D14/60
D. 260,518	9/1981	Larson	D14/53
D. 265,401	7/1982	Genaro et al.	D14/60
D. 265,734	8/1982	Mahan	D14/60
3,911,446	10/1975	Albertini	179/2 TC X
3,982,072	9/1976	Dean	179/2 TC
4,107,477	8/1978	Morrison	179/179

FOREIGN PATENT DOCUMENTS

2636848 2/1978 Fed. Rep. of Germany ... 179/100 R
888997 6/1959 United Kingdom D14/56

OTHER PUBLICATIONS

Retail Home Furnishings (Supplement), Jan. 23, 1978, The World Talks on ITT, Telephones, Radio Telephone.

Primary Examiner—Bernard Ansher
Attorney, Agent, or Firm—Kirschstein, Kirschstein, Ottinger & Cobrin

[57] CLAIM

The ornamental design for a telephone, substantially as shown and described.

DESCRIPTION

FIG. 1 is a front elevation of a telephone showing my new design;
FIG. 2 is a left side elevation thereof;
FIG. 3 is a top plan view thereof;
FIG. 4 is a rear elevation thereof;
FIG. 5 is a bottom plan view thereof; and
FIG. 6 is a front elevation with the handset removed from the telephone base for clarity of illustration.

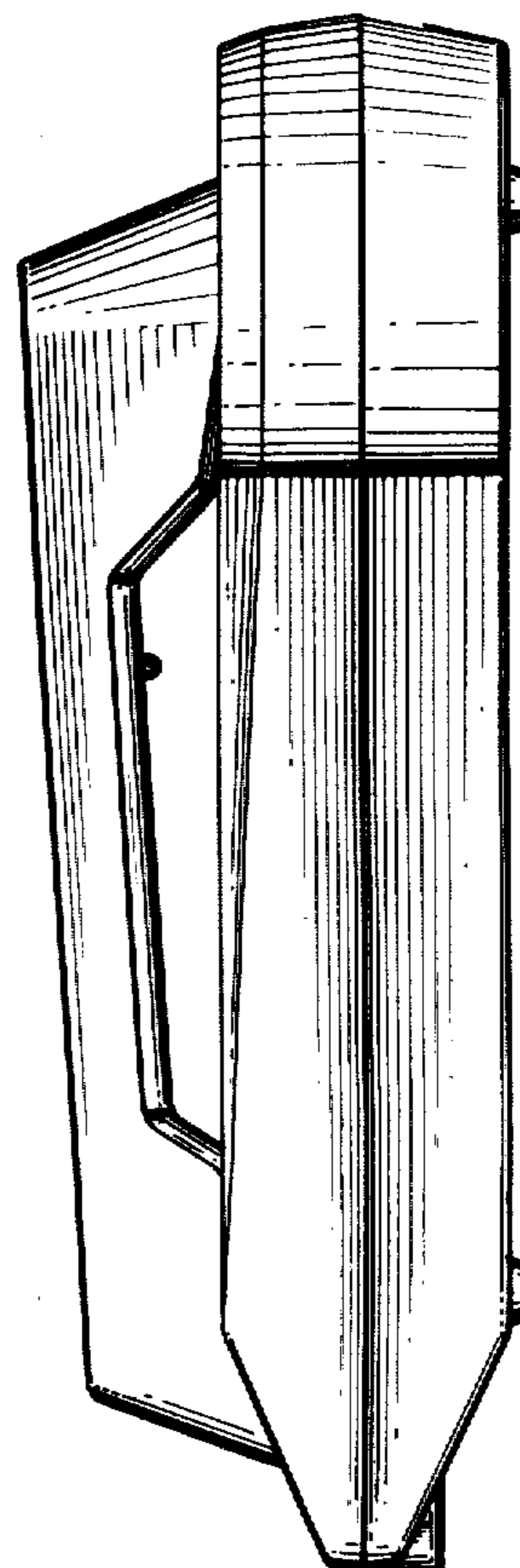
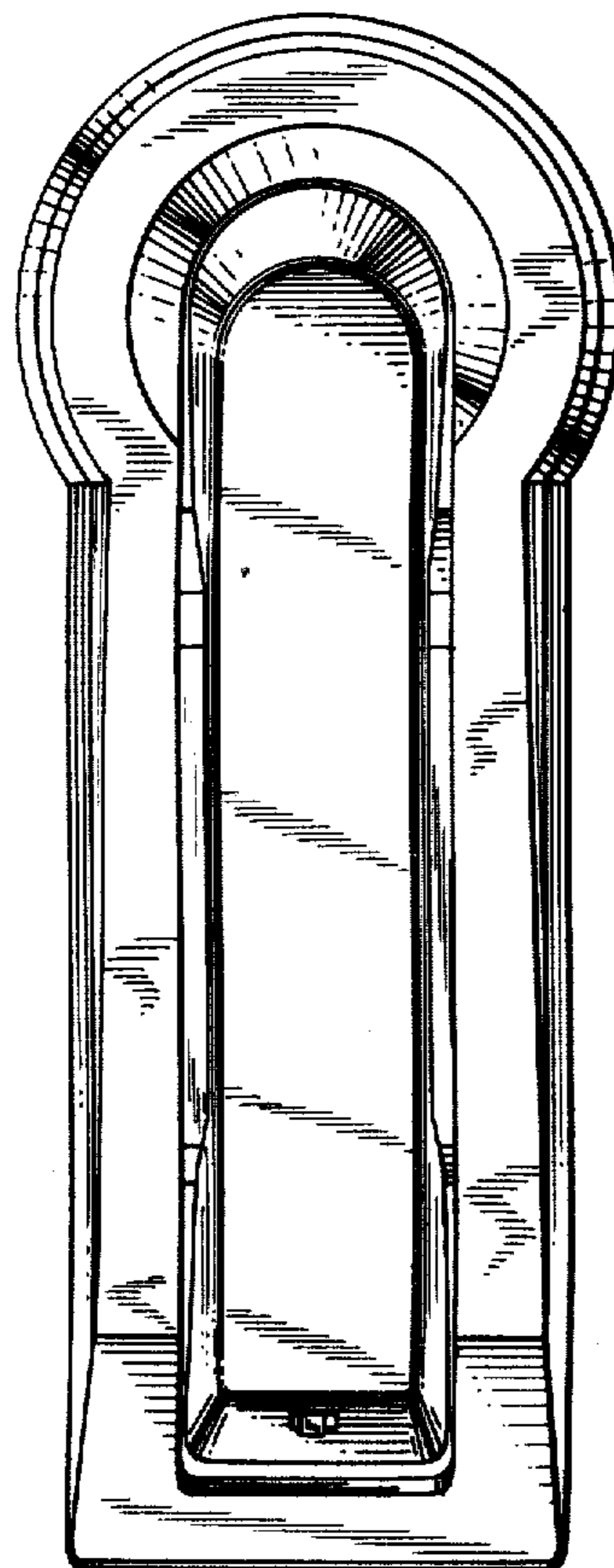

FIG. 1

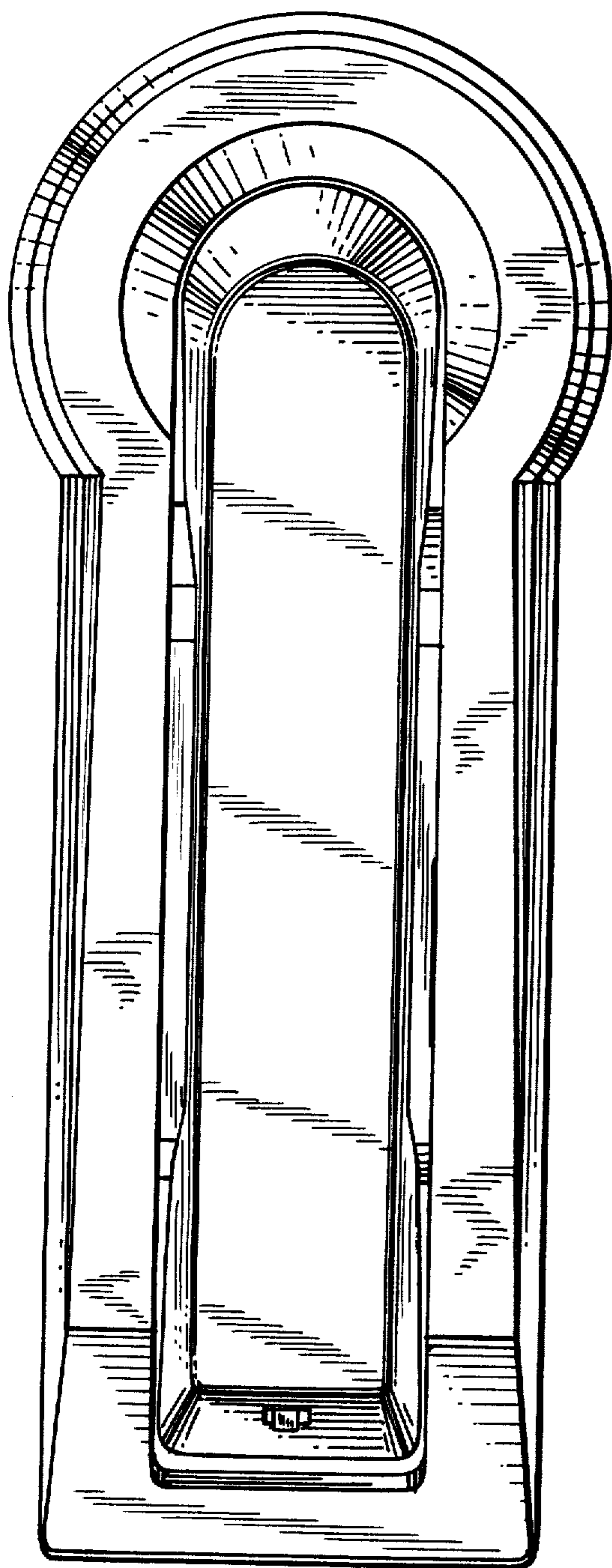

FIG. 2

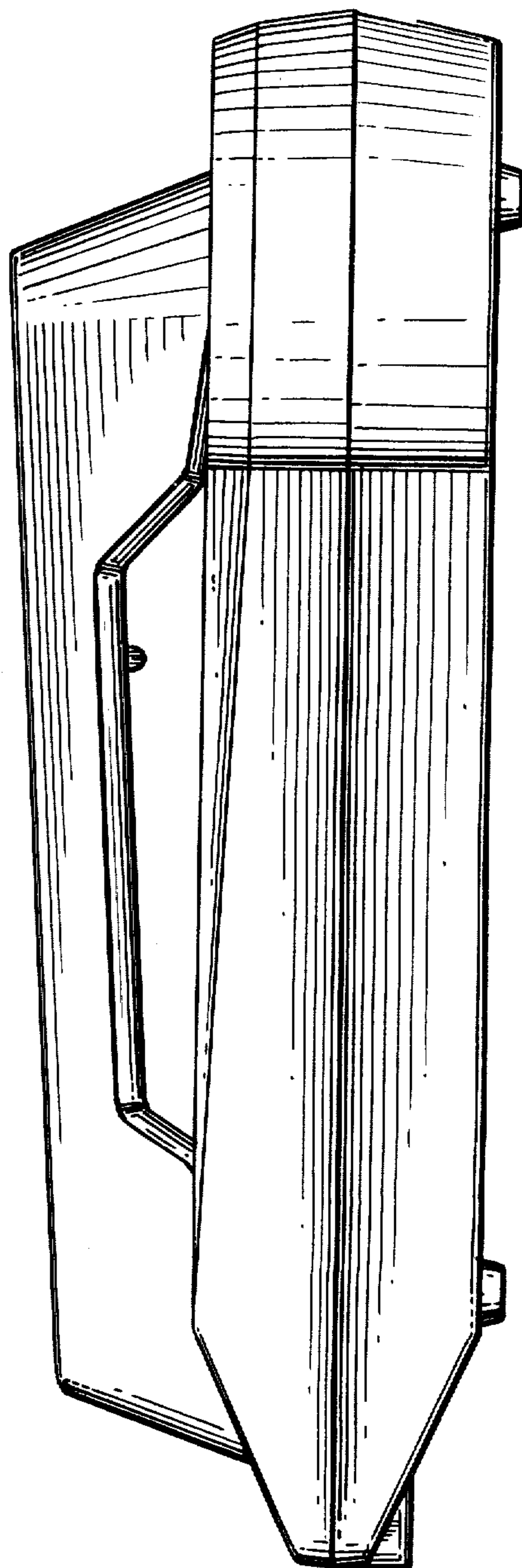

FIG. 3

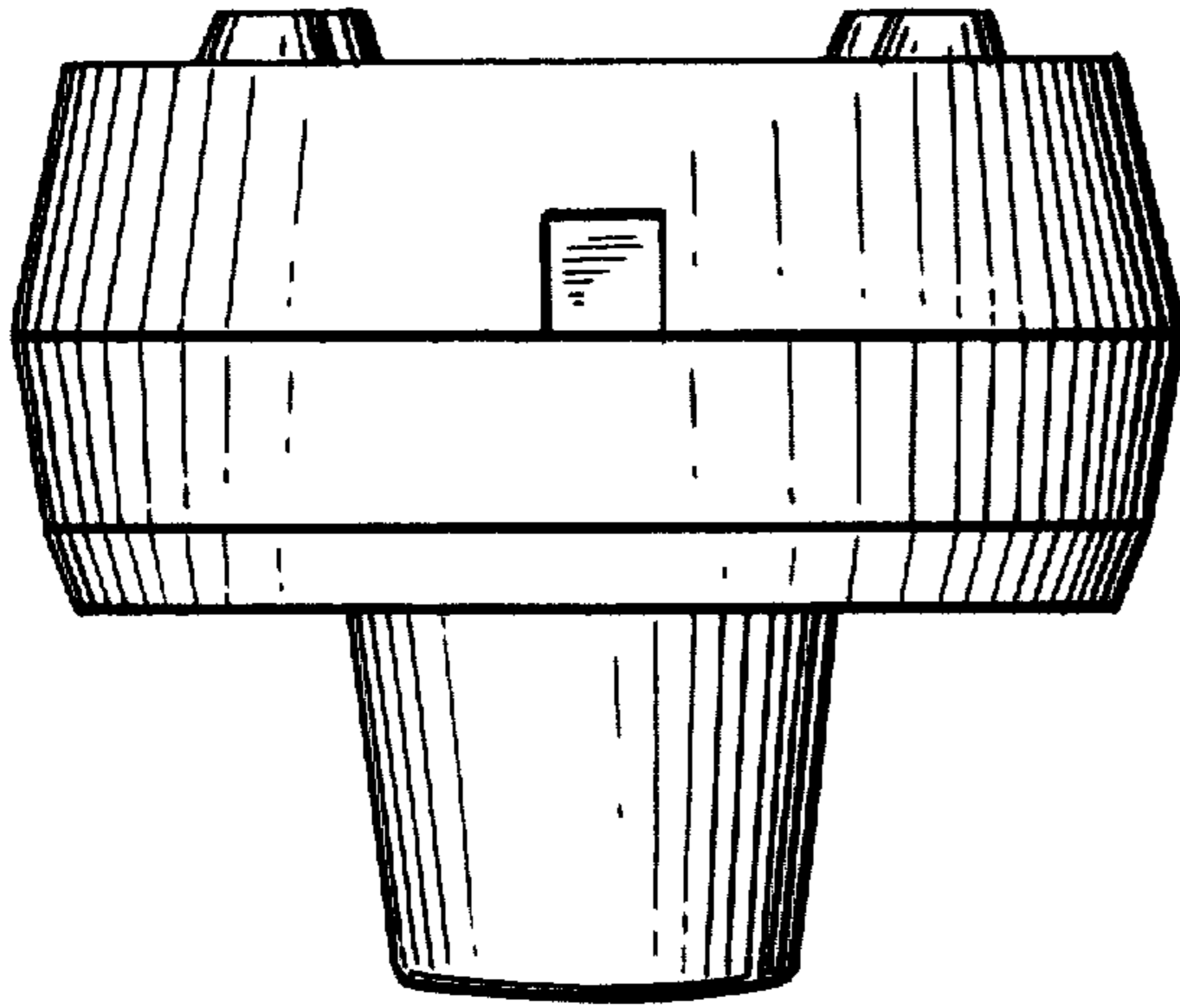

FIG. 4

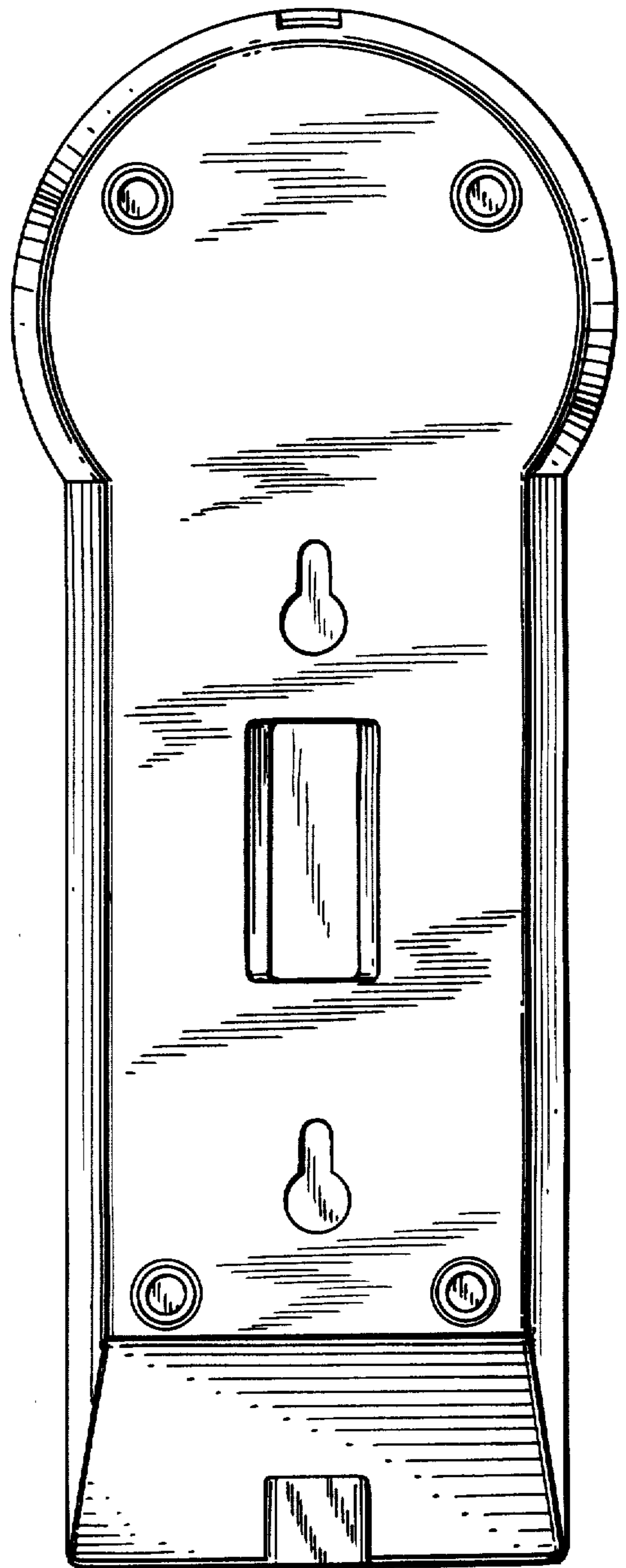

FIG. 5

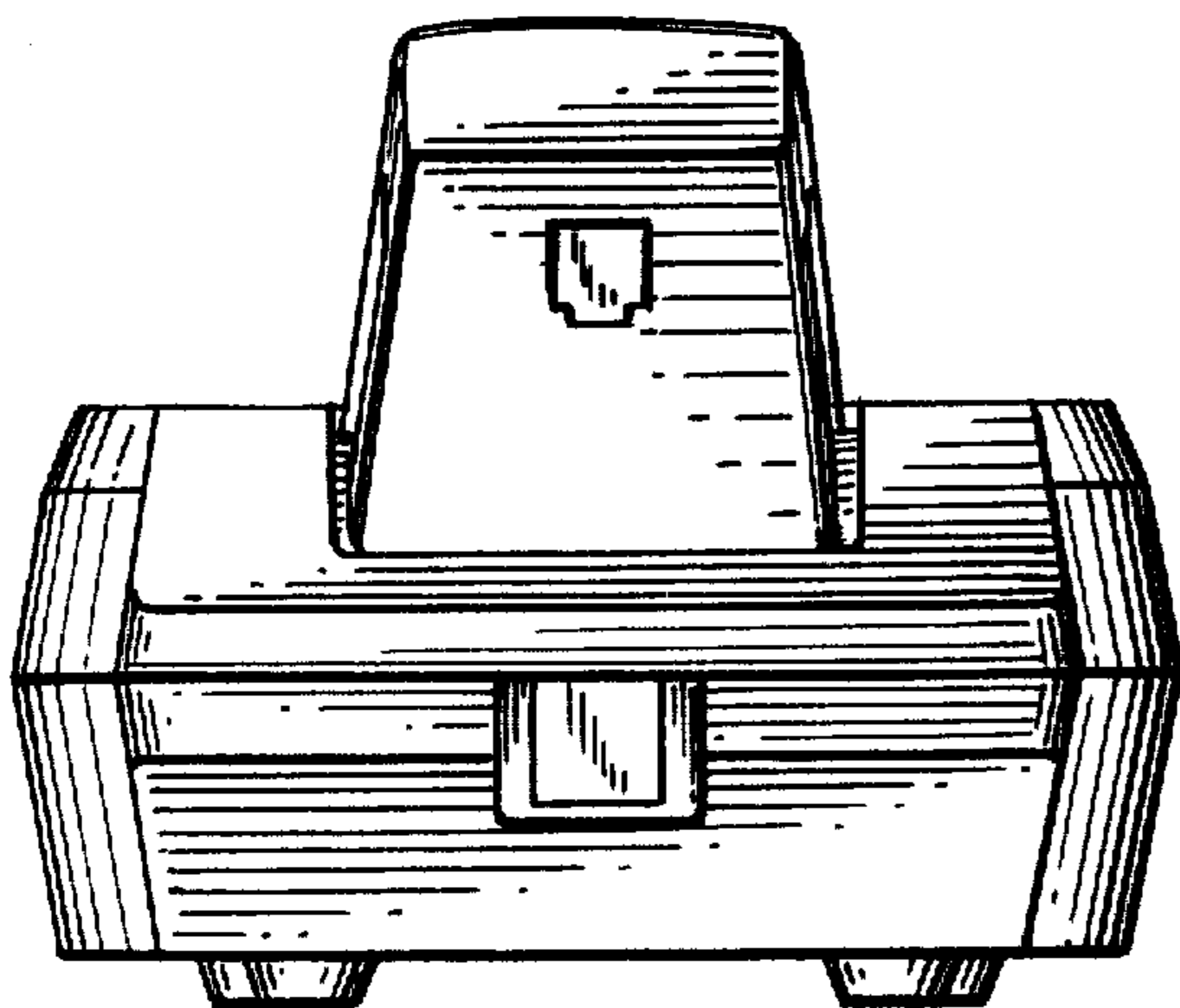

FIG. 6

