

[54] PHYSICAL EXERCISE SUPPORT

[76] Inventor: Thomas E. Beer, 9206 Holland Ave., Durham, Calif. 95938

[**] Term: 14 Years

[21] Appl. No.: 224,704

[22] Filed: Jan. 12, 1981

[51] Int. Cl. D21-02

[52] U.S. Cl. D21/191

[58] Field of Search 272/144, 138, 134, 116, 272/120, 142; D21/191-199

[56] References Cited

U.S. PATENT DOCUMENTS

2,673,736	3/1954	Fiumedoro	272/144
2,783,045	2/1957	Bosch	272/144
4,072,309	2/1978	Wilson	272/144

OTHER PUBLICATIONS

AMF Whitely Catalog, 1980, p. 27, "Wall Unit" Exerciser with Bench.

Primary Examiner—Charles A. Rademaker
Attorney, Agent, or Firm—Townsend & Townsend

[57] CLAIM

The ornamental design for a physical exercise support, as shown and described.

DESCRIPTION

FIG. 1 is a front perspective view of a physical exercise support showing my new design;
 FIG. 2 is a top plan view thereof;
 FIG. 3 is a front elevational view thereof;
 FIG. 4 is a right side elevational view thereof;
 FIG. 5 is a left side elevational view thereof;
 FIG. 6 is a rear elevational view thereof;
 FIG. 7 is a bottom plan view thereof;
 FIG. 8 is a front perspective view of the design shown in FIGS. 1 through 7 in an alternate condition;
 FIG. 9 is a top plan view thereof;
 FIG. 10 is a front elevational view thereof;
 FIG. 11 is a left side elevational view thereof;
 FIG. 12 is a rear elevational view thereof;
 FIG. 13 is a bottom plan view thereof; and,
 FIG. 14 is a right side elevational view thereof.

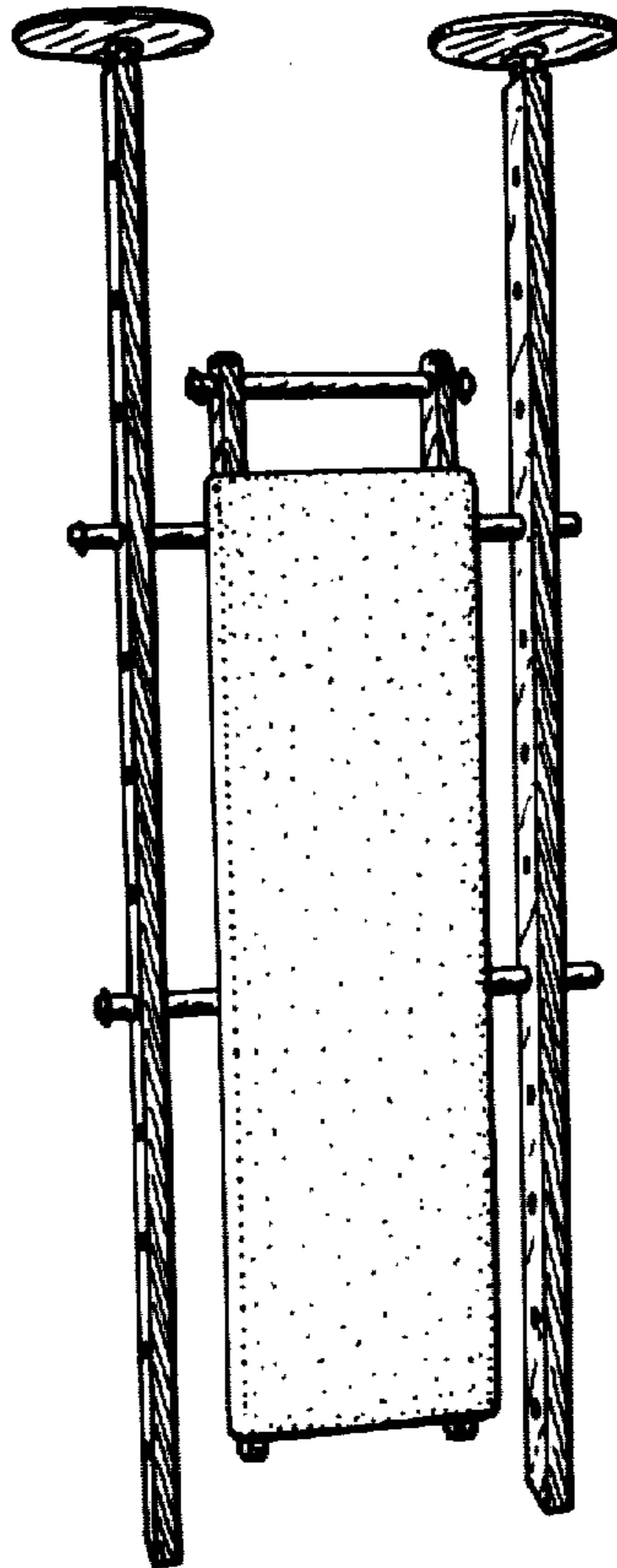

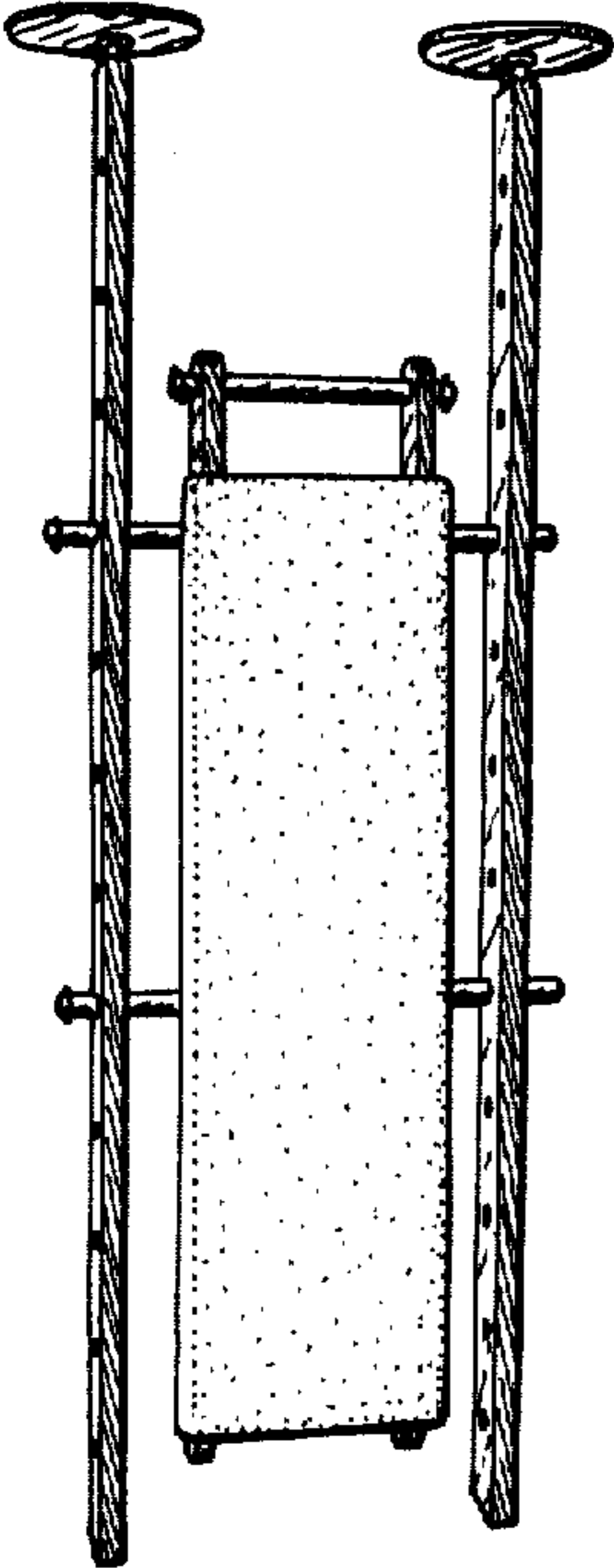

FIG. 1.

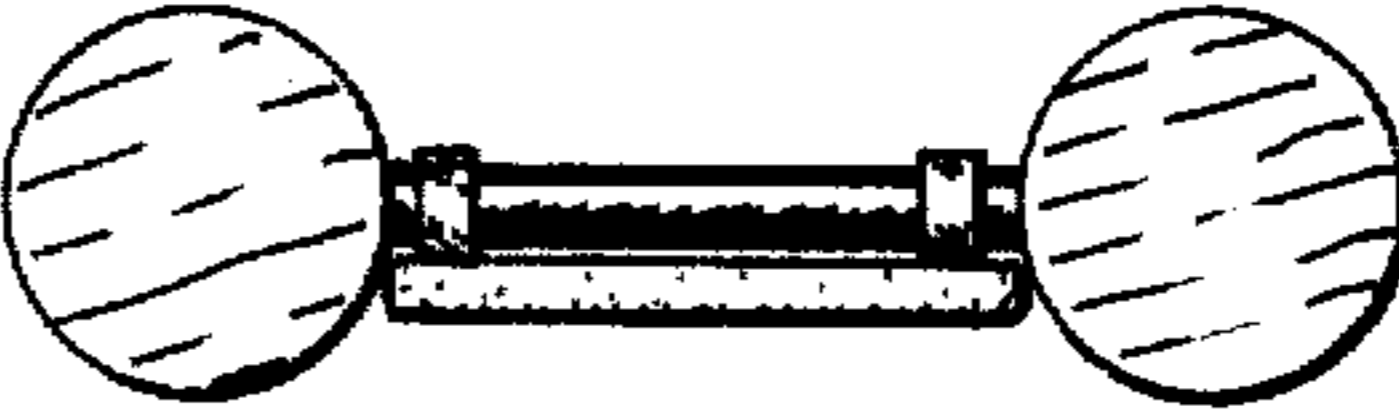

FIG. 2.

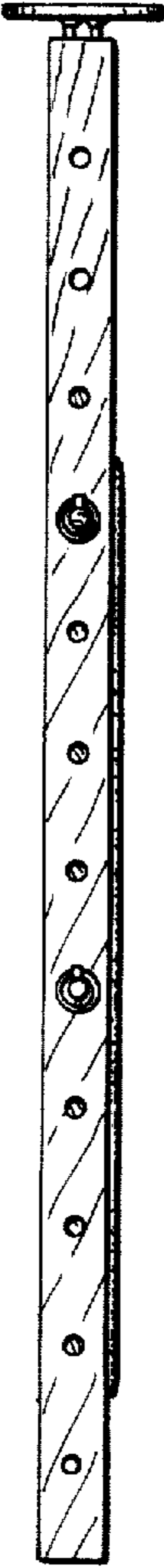

FIG. 5.

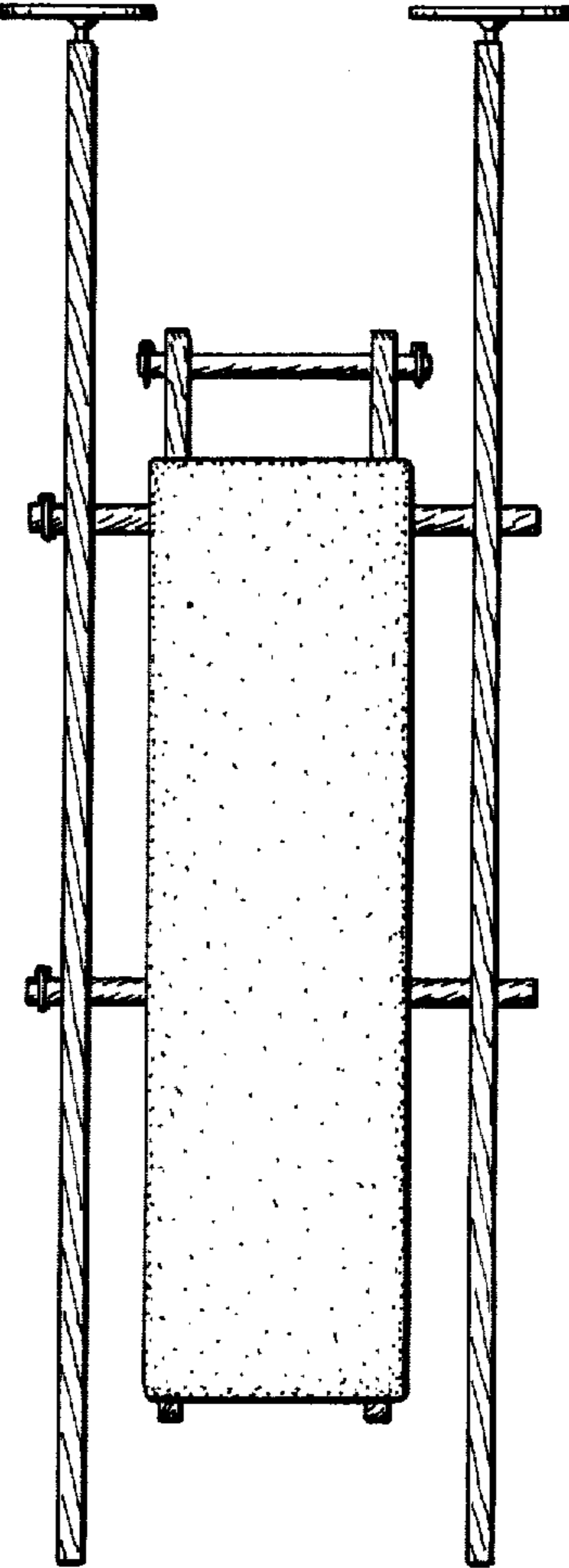

FIG. 3.

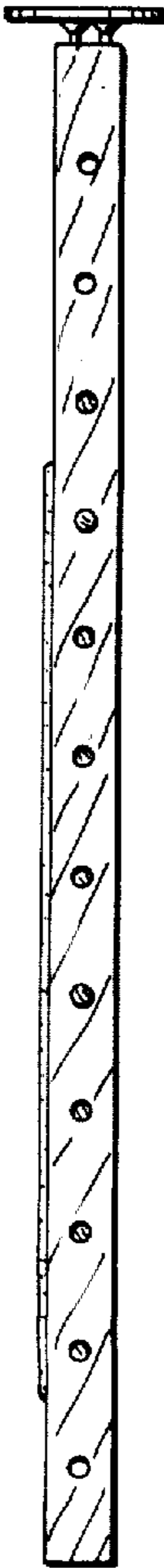

FIG. 4.



FIG. 7.

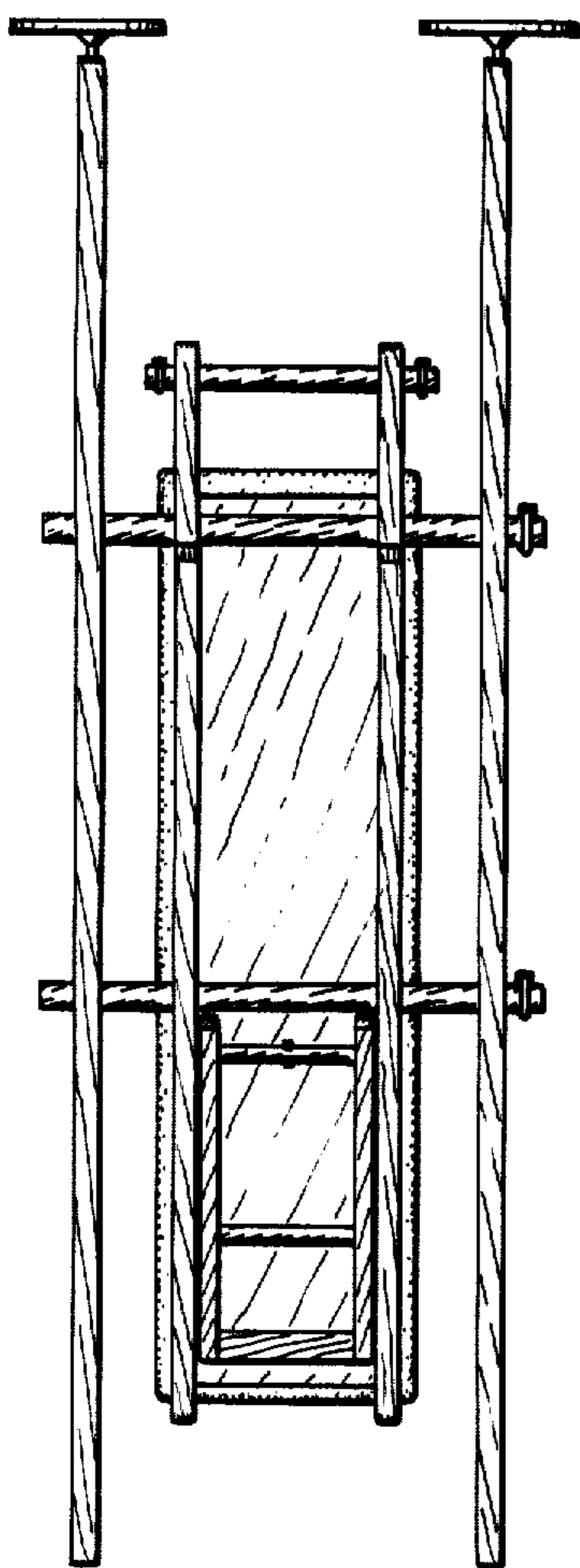

FIG. 6.

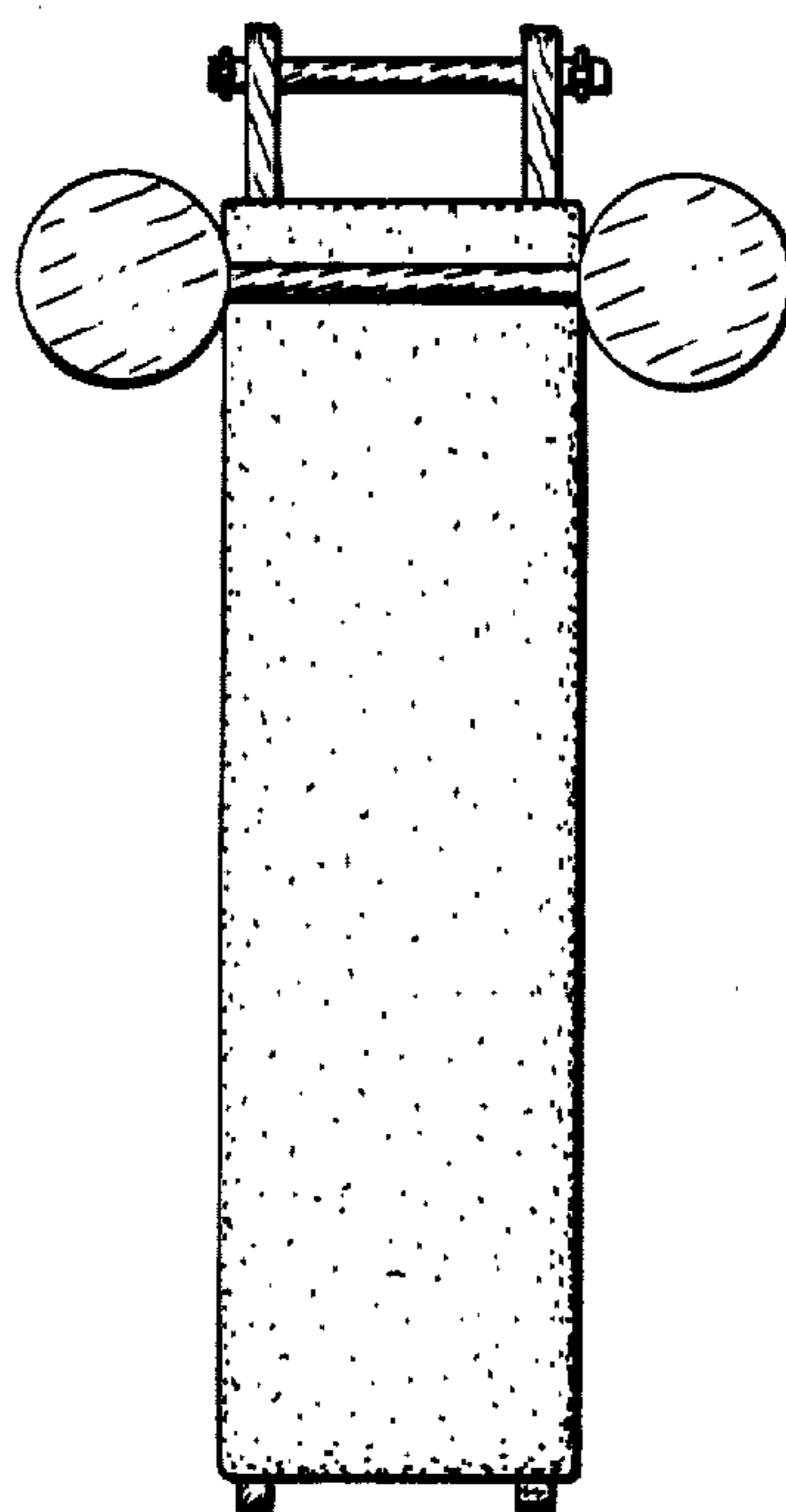

FIG. 9.

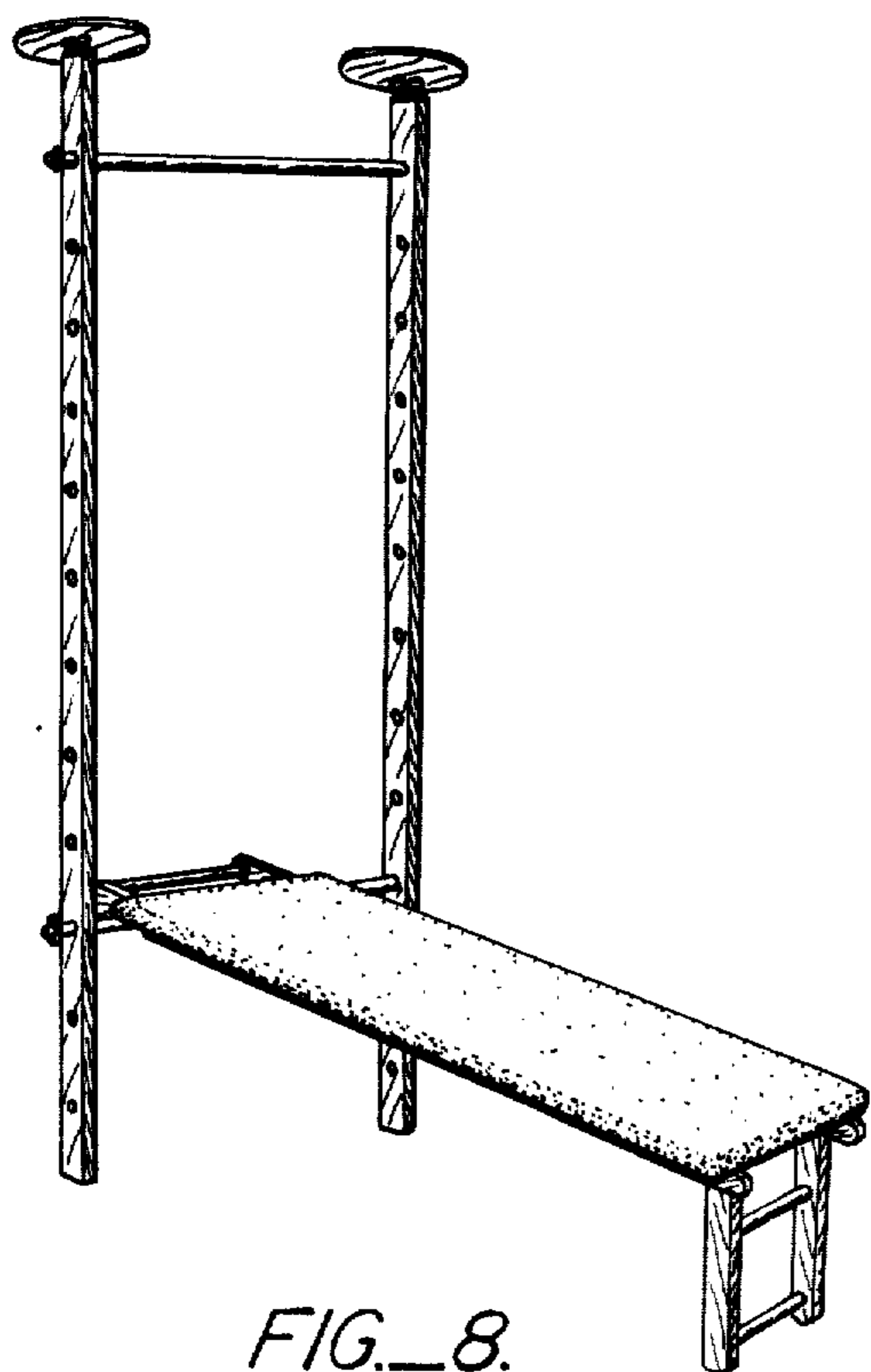

FIG. 8.

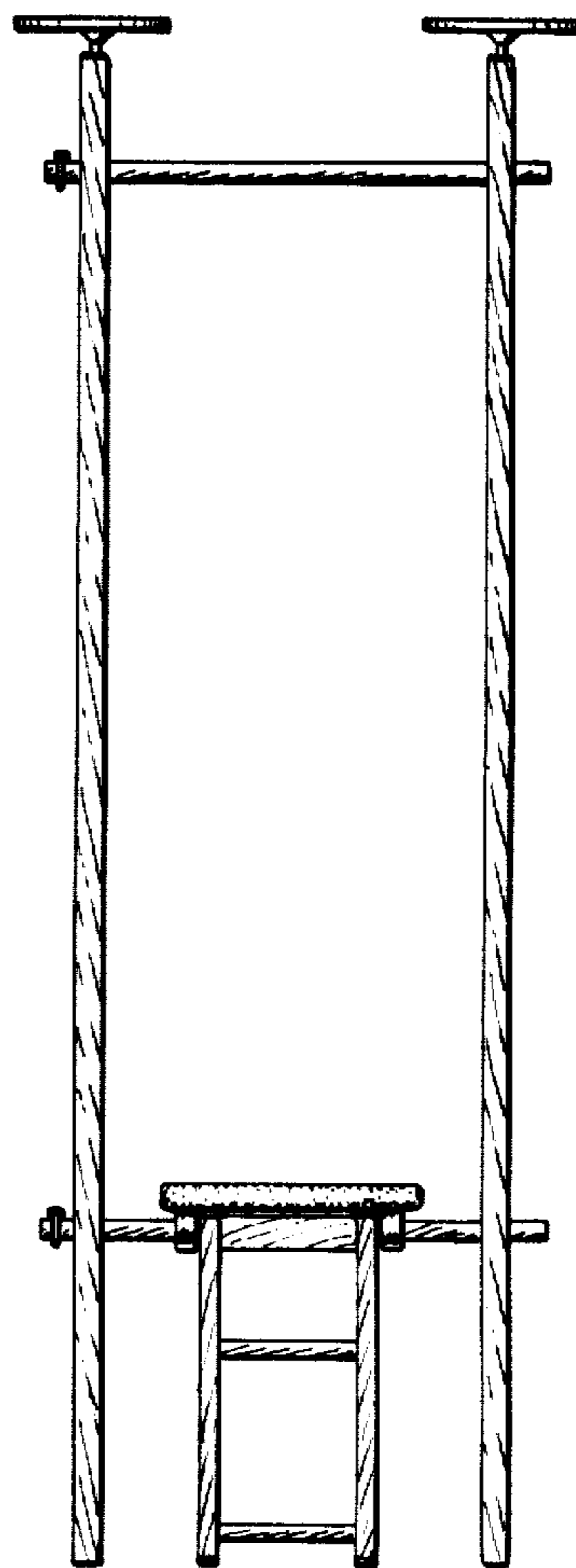

FIG. 10.

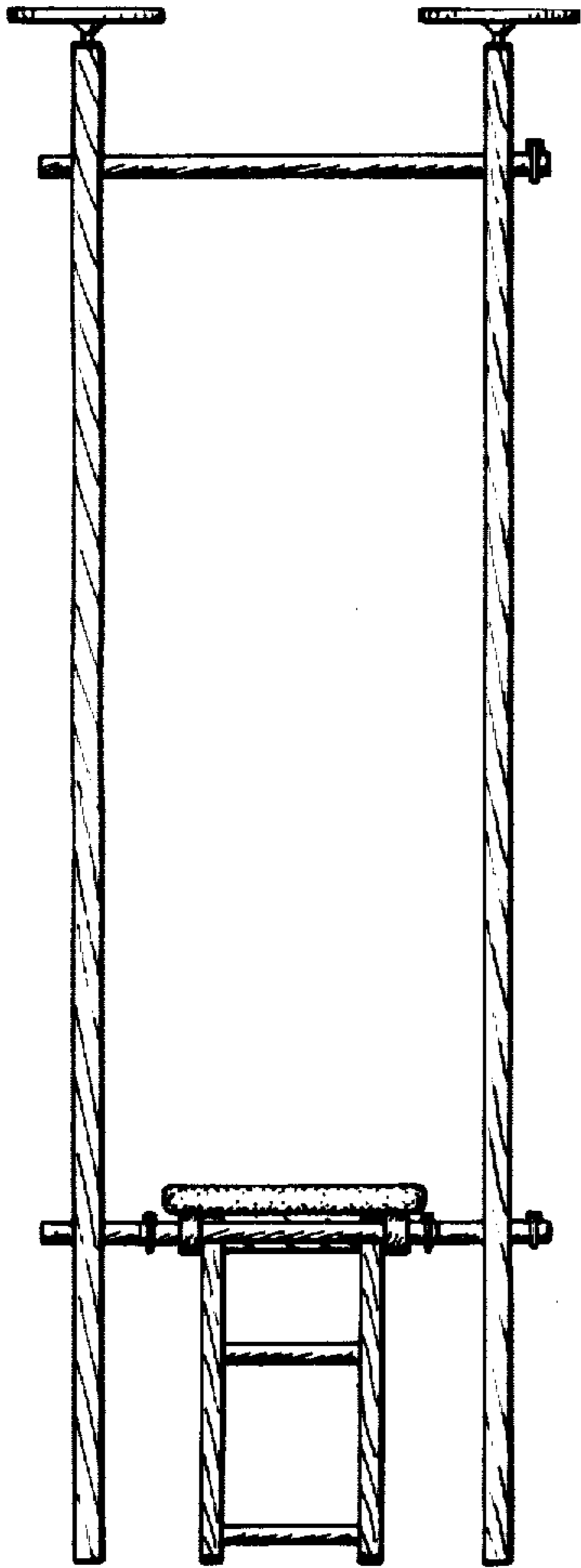

FIG. 12.

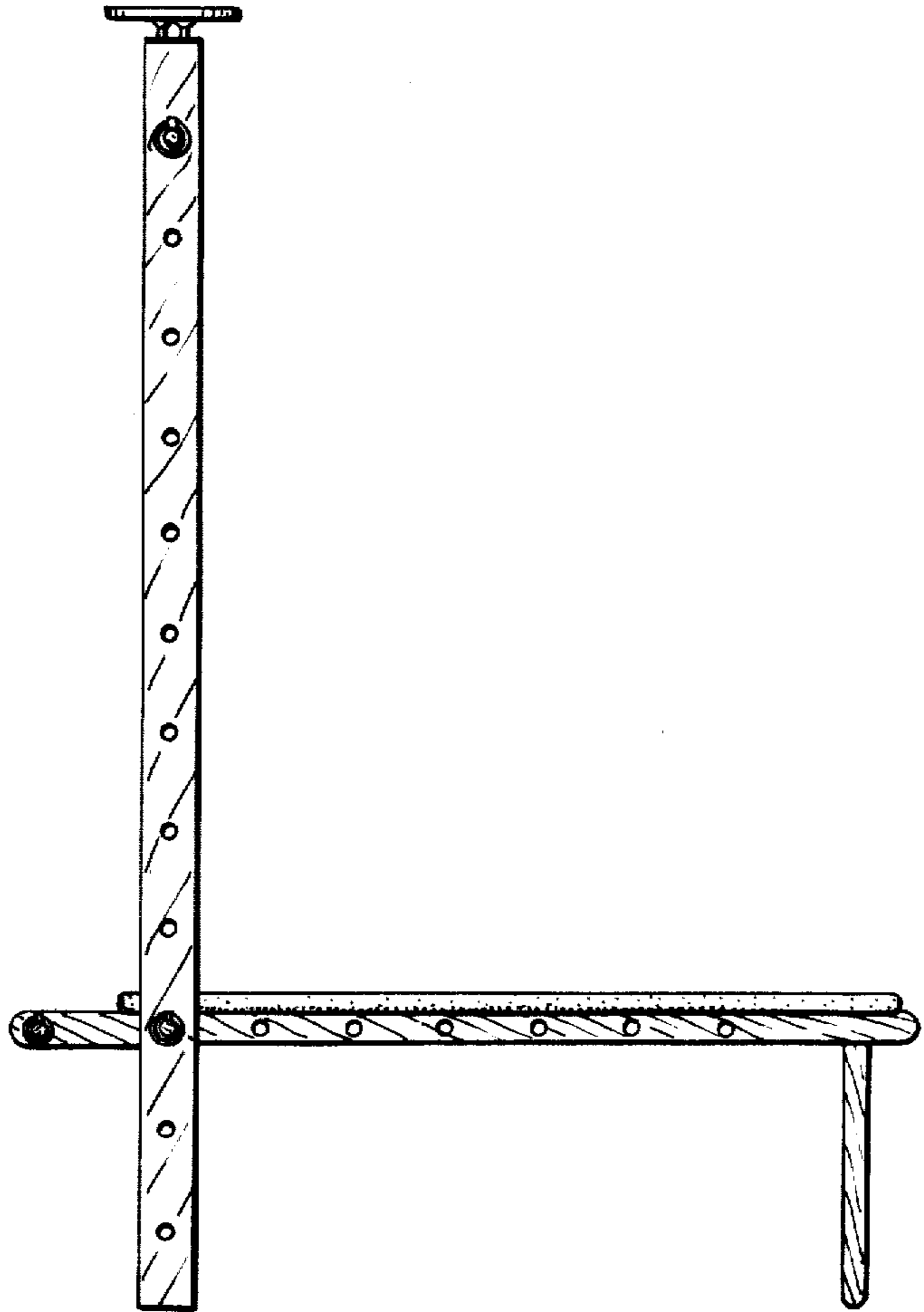

FIG. 11.

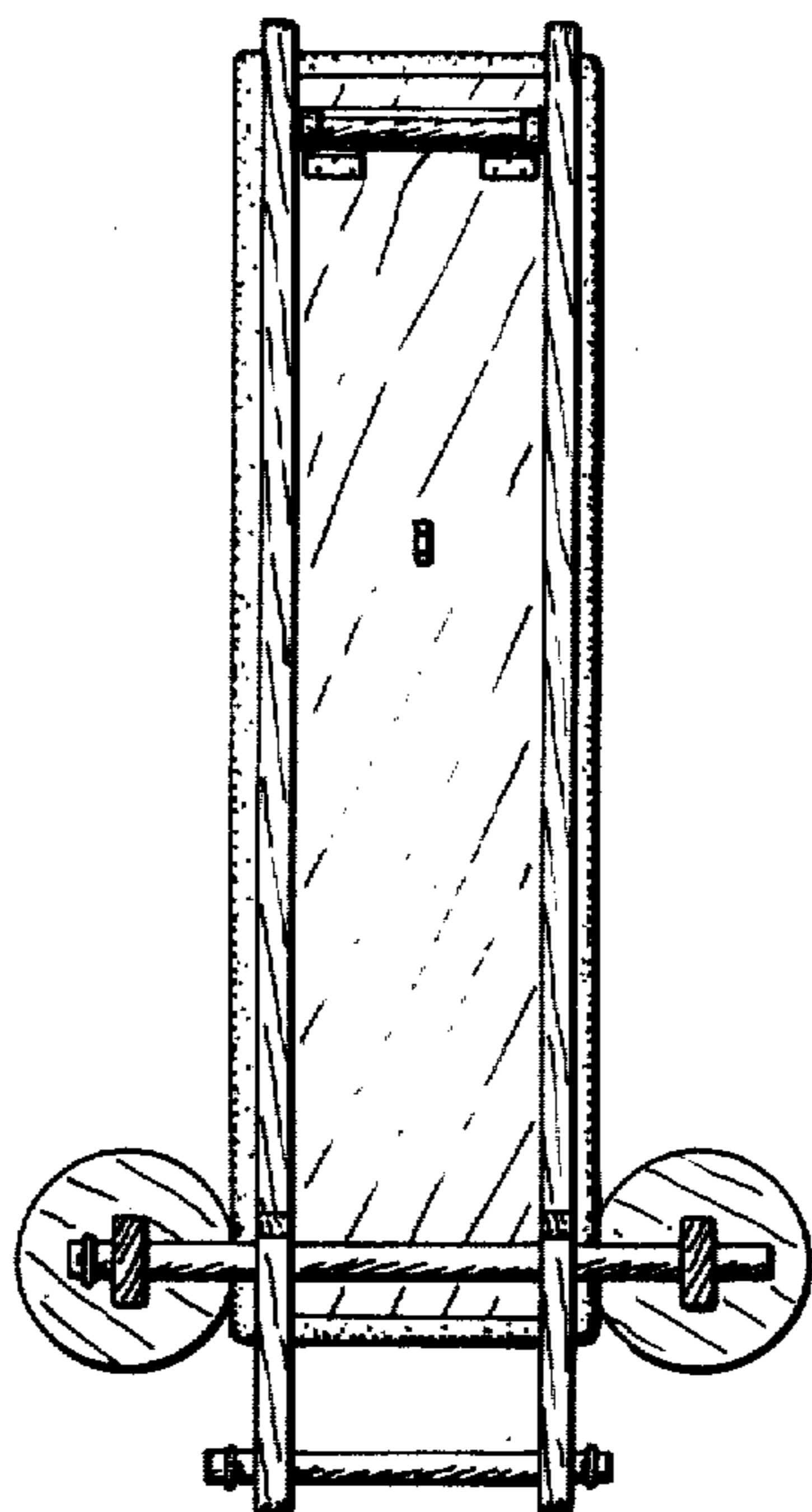

FIG. 13.

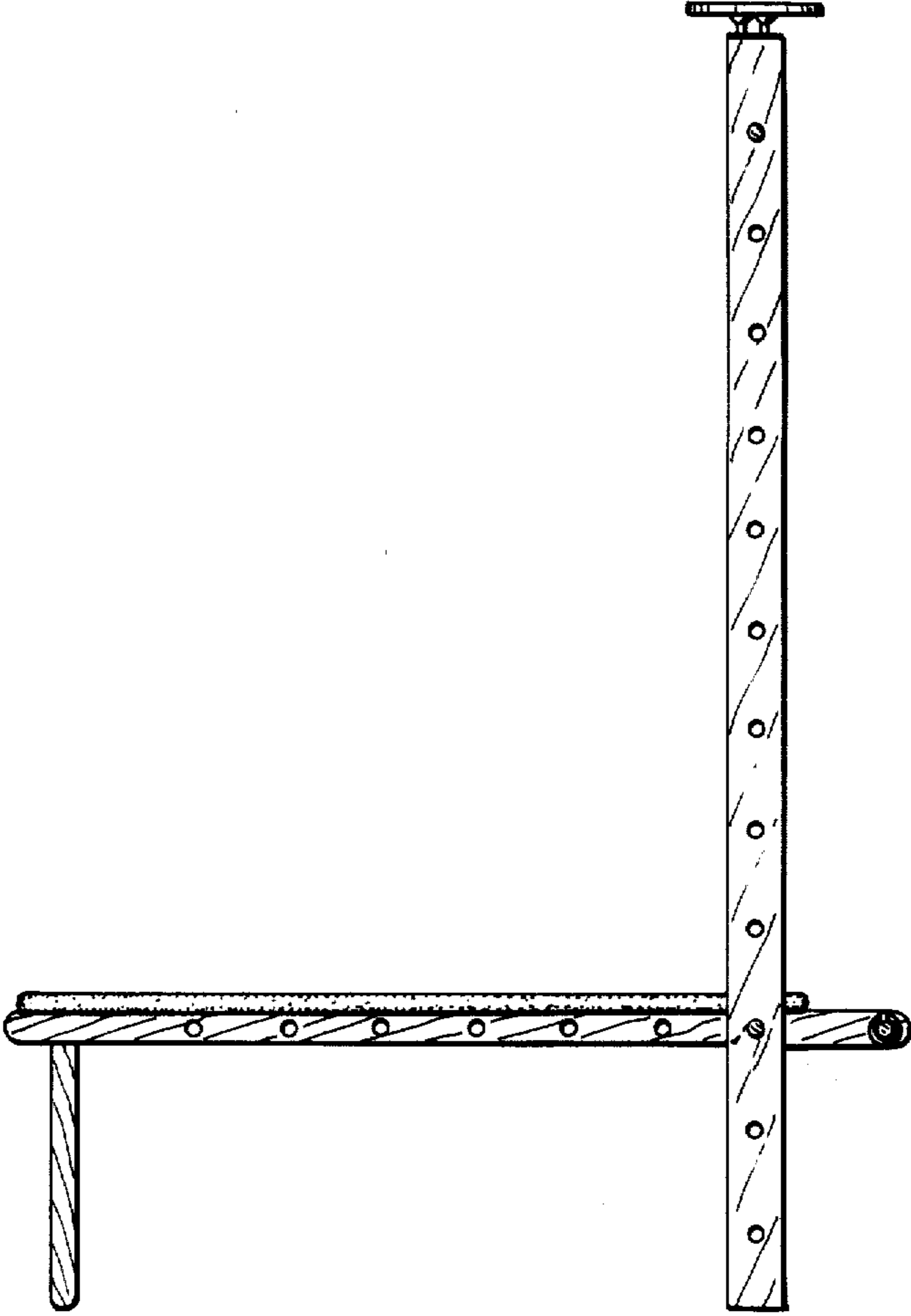

FIG. 14.