

[54] LUGGAGE

[75] Inventor: Ted Stark, Montclair, N.J.

[73] Assignee: M/M Verdi International, Inc.,
Jersey City, N.J.

[**] Term: 14 Years

[21] Appl. No.: 366,405

[22] Filed: Apr. 7, 1982

[51] Int. Cl. D3-01

[52] U.S. Cl. D3/71; D3/53;
D3/77

[58] Field of Search D3/30.1, 48, 71, 76,
D3/77, 53; 190/41 Z, 41 R, 48, 52, 53

[56] References Cited

U.S. PATENT DOCUMENTS

- D. 163,552 6/1951 Adams D3/71
- D. 264,023 4/1982 Stark D3/71

OTHER PUBLICATIONS

Luggage & Travelware 7/76, p. 5, Item "A".
Luggage & Travelware 10/81, p. 34, Item "A".

Primary Examiner—George P. Word
Attorney, Agent, or Firm—Hubbell, Cohen, Stiefel &
Gross

[57] CLAIM

The ornamental design for luggage, substantially as shown and described.

DESCRIPTION

FIG. 1 is a perspective view of luggage showing my new design;
 FIG. 2 is a right side elevational view thereof;
 FIG. 3 is a left side elevational view thereof;
 FIG. 4 is a top plan view thereof;
 FIG. 5 is a bottom plan view thereof;
 FIG. 6 is a front elevational view thereof;
 FIG. 7 is a rear elevational view thereof;
 FIG. 8 is a front perspective view of an alternate embodiment of the luggage; and
 FIG. 9 is a bottom rear perspective view of FIG. 8.

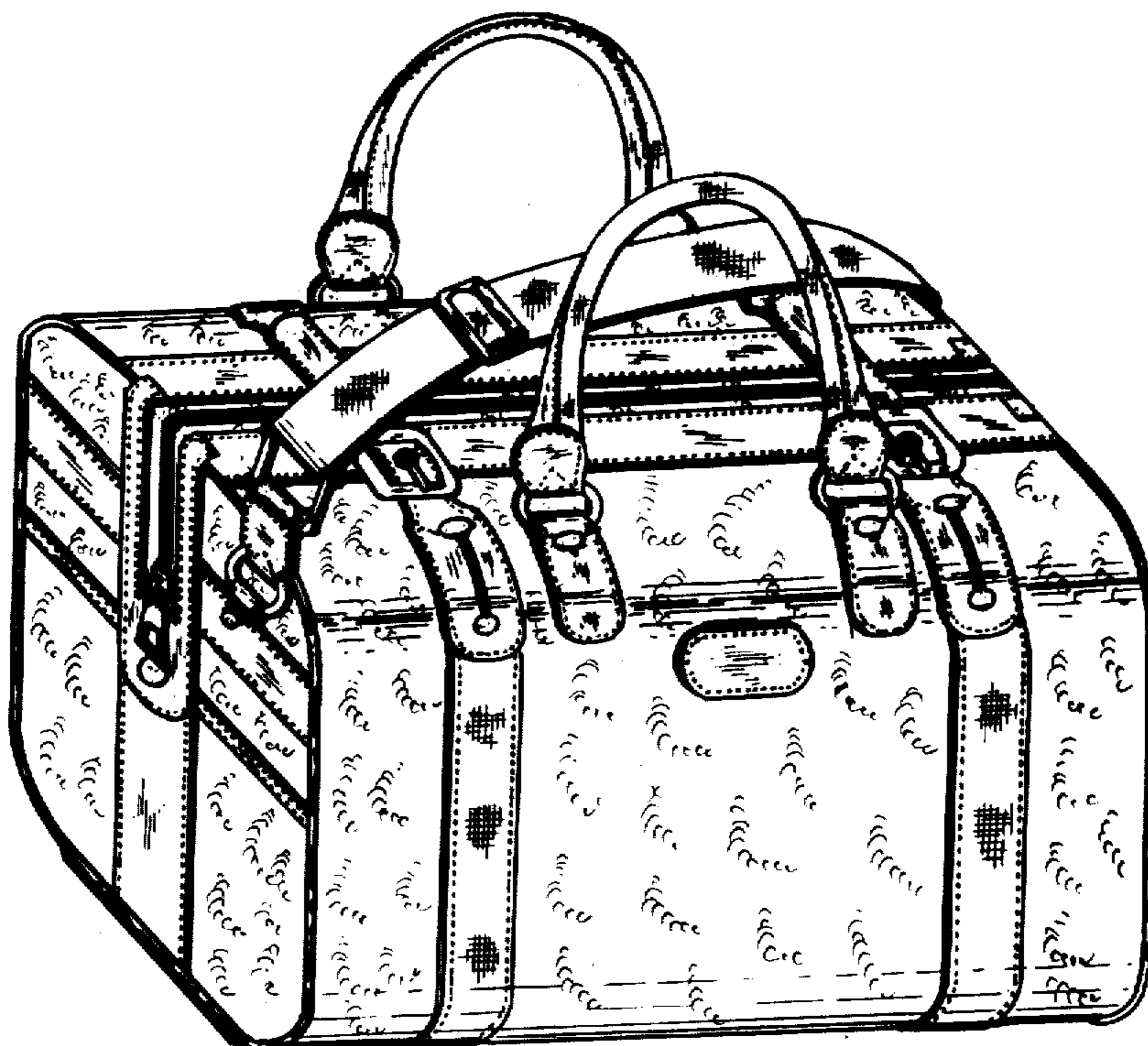

FIG. 2.

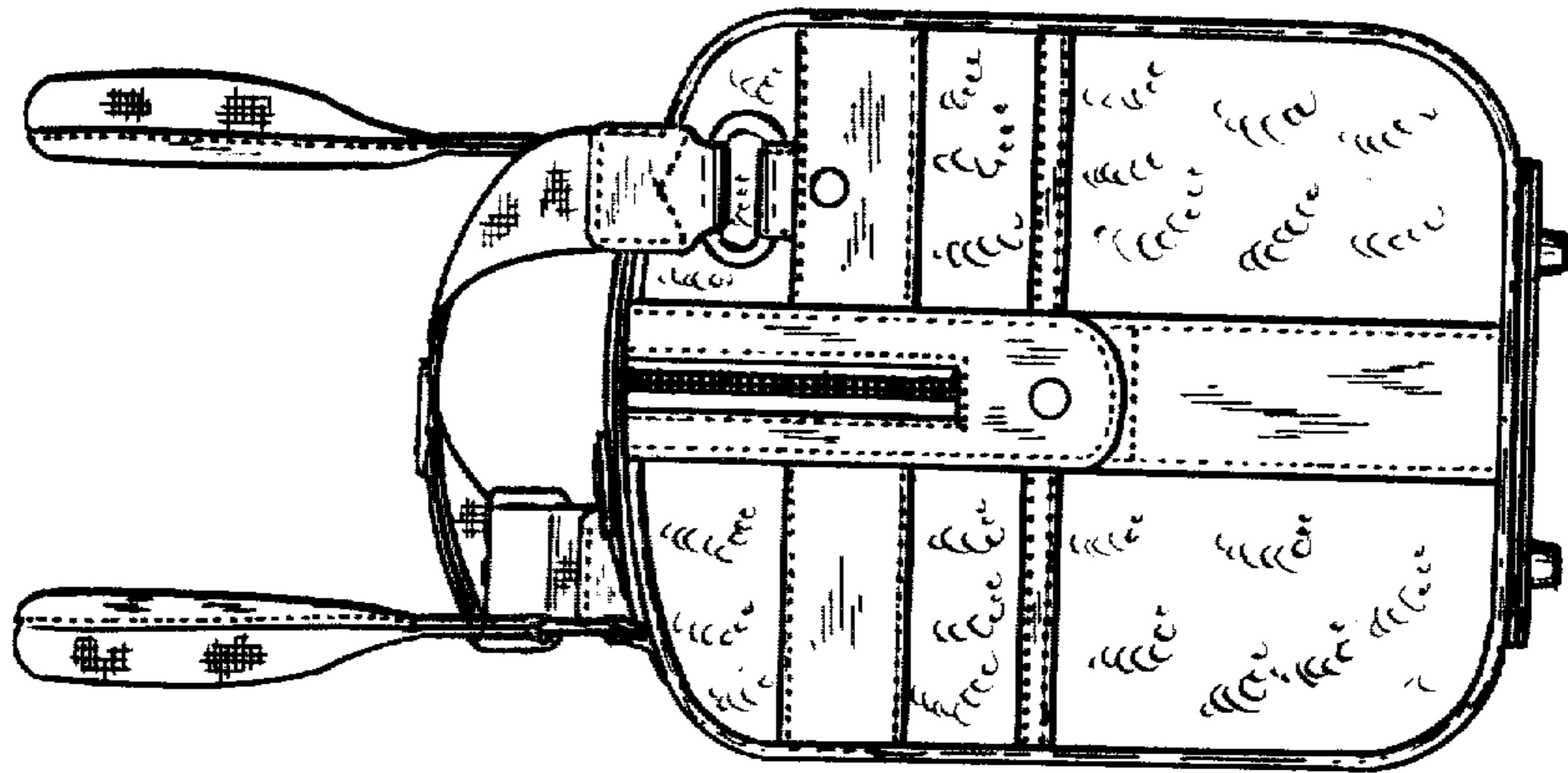

FIG. 1.

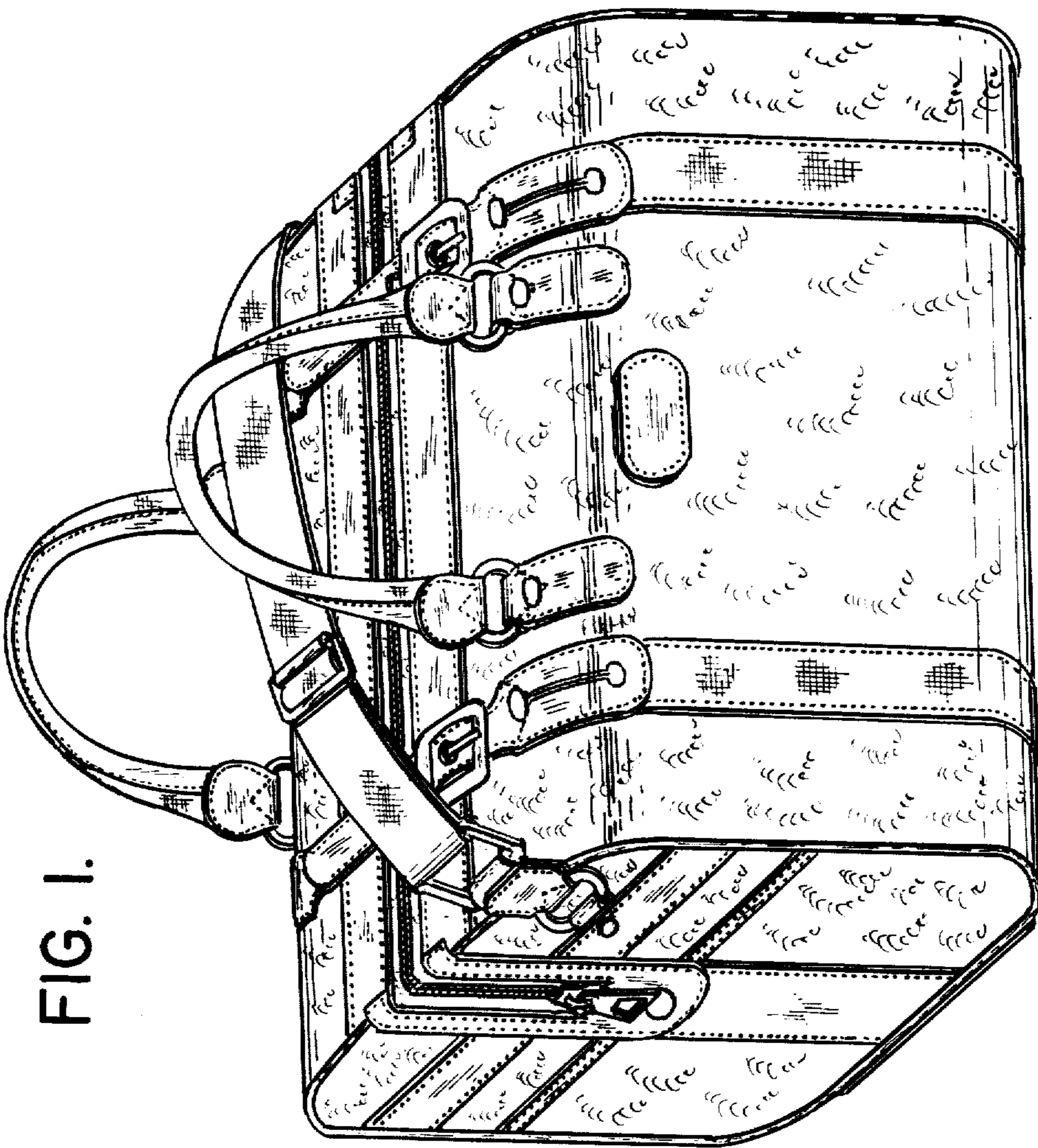

FIG. 3.

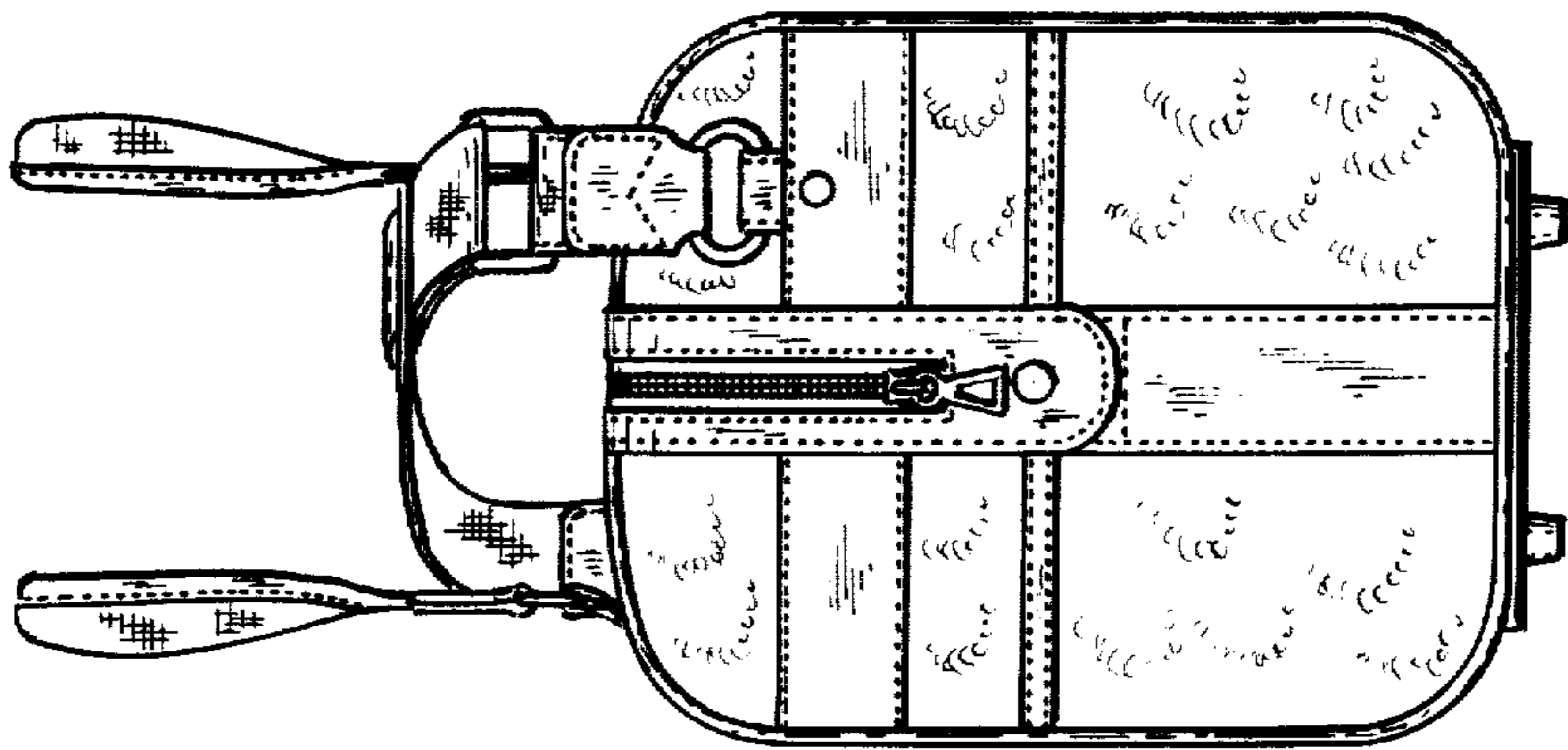

FIG. 4.

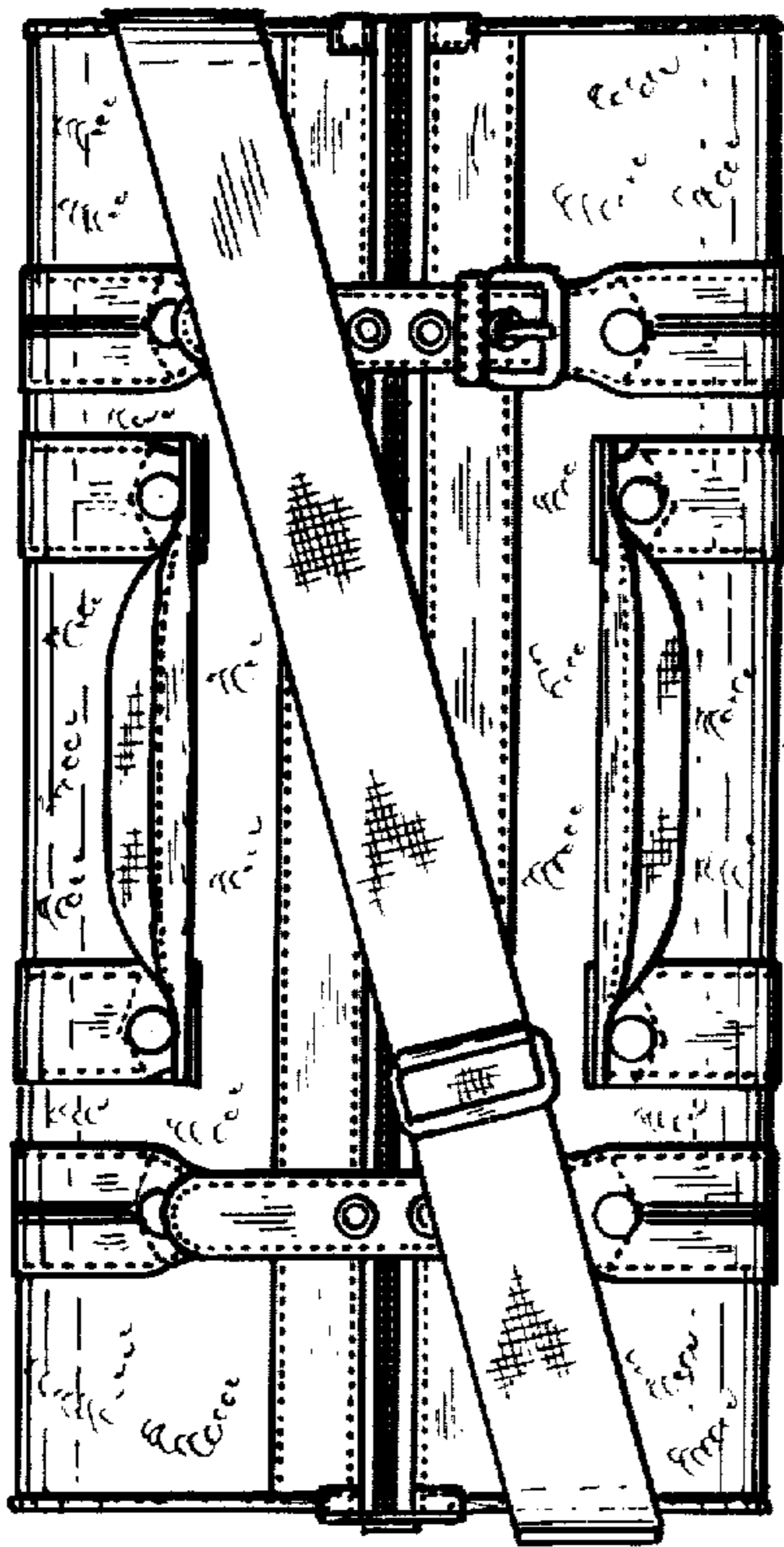

FIG. 5.

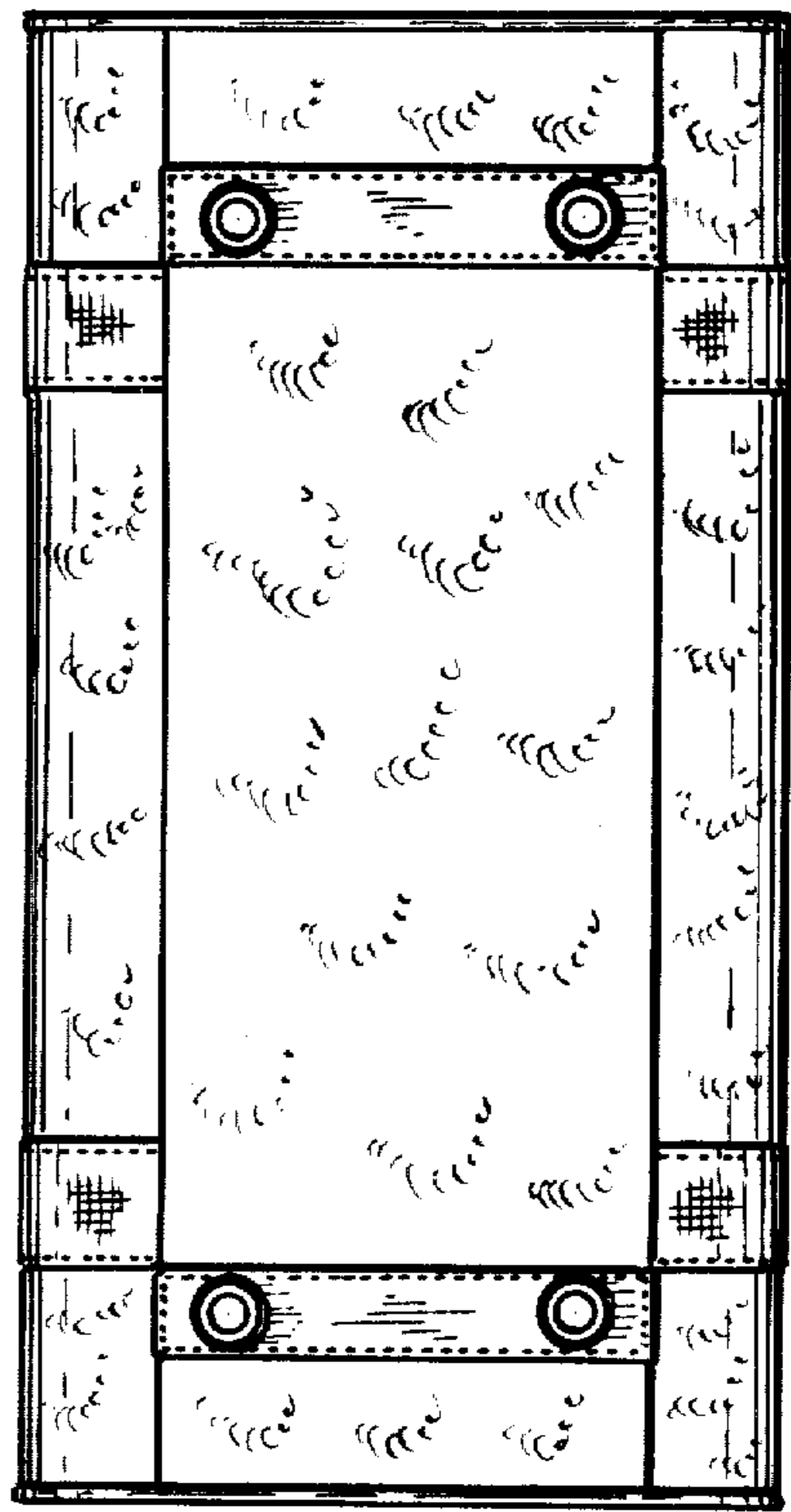

FIG. 7.

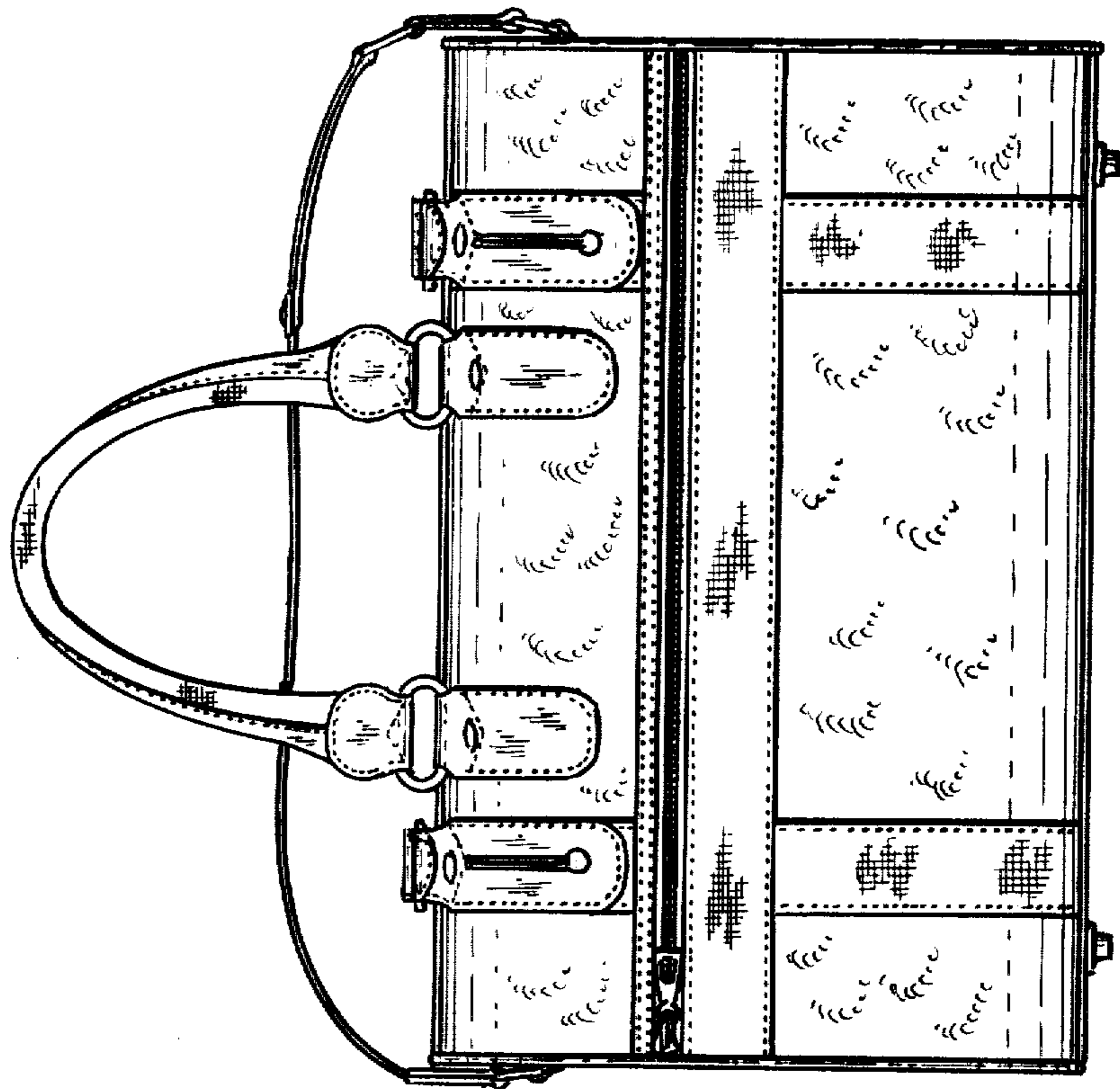

FIG. 6.

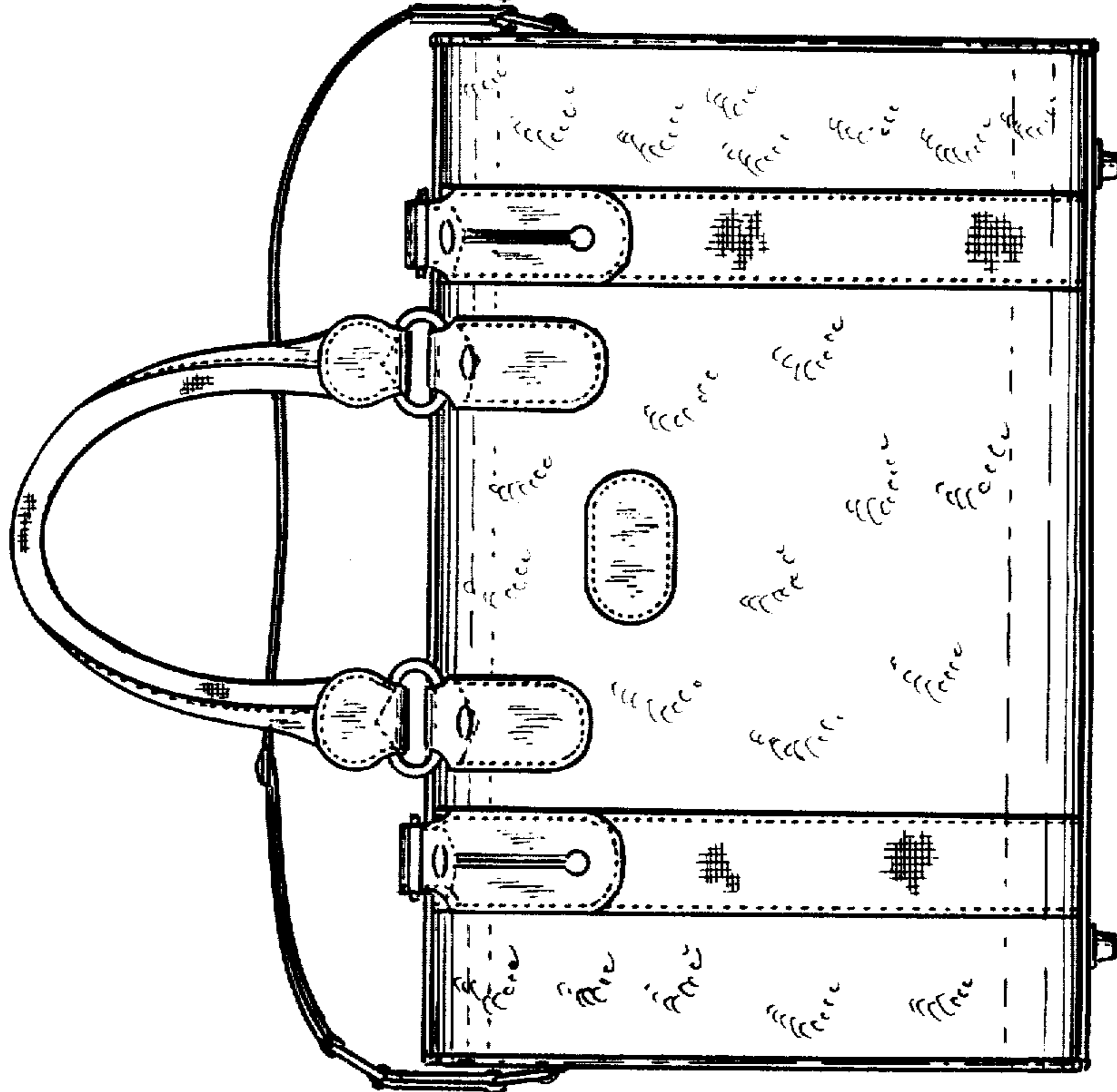

FIG. 8.

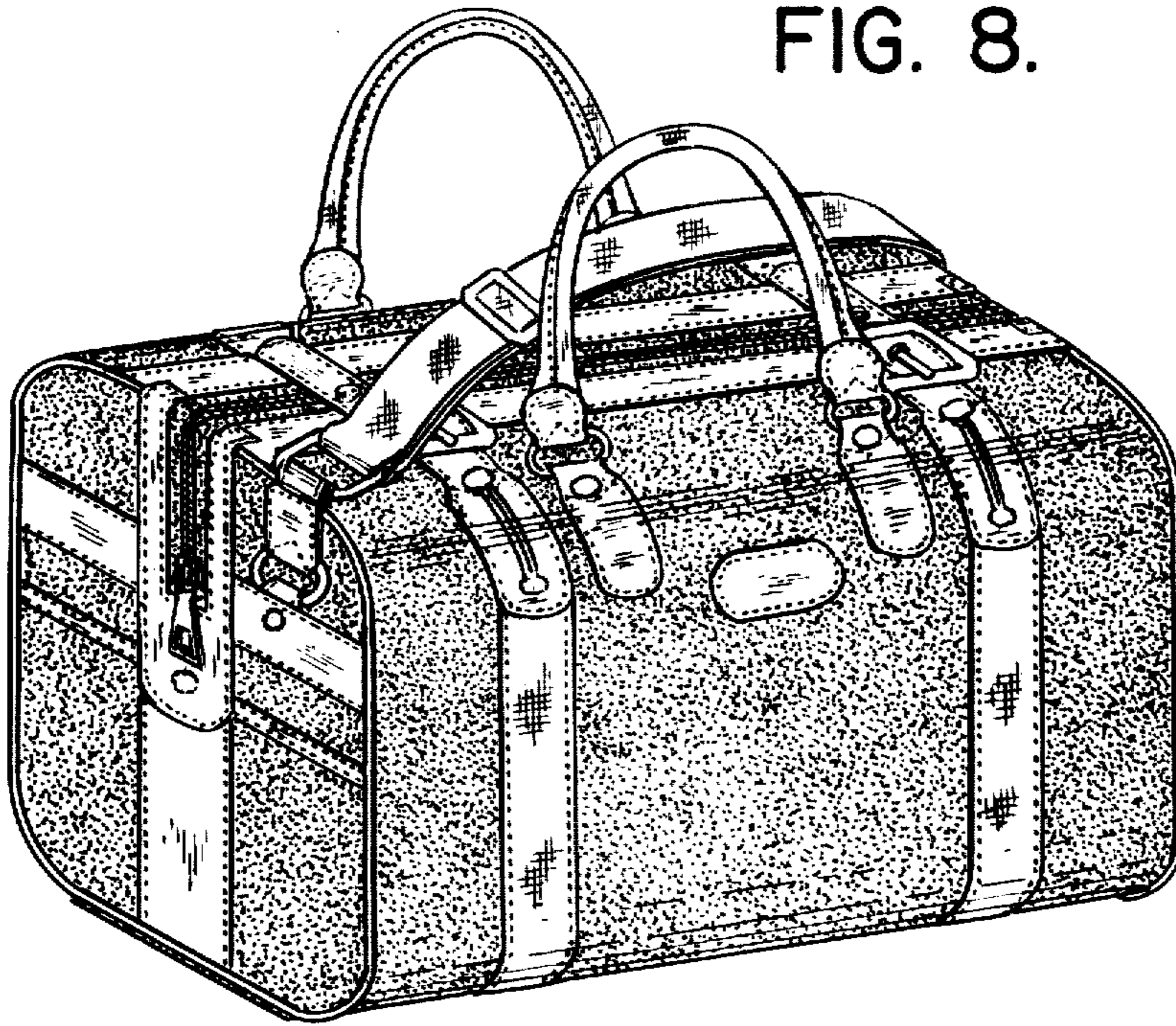

FIG. 9.

