

[54] **ARTICULATE KNEE BRACE**
 [75] **Inventor:** Gary R. Bledsoe, Arlington, Tex.
 [73] **Assignee:** Medical Designs, Inc., Arlington, Tex.
 [**] **Term:** 14 Years
 [21] **Appl. No.:** 222,027
 [22] **Filed:** Jan. 2, 1981
 [51] **Int. Cl.** D24-03
 [52] **U.S. Cl.** D24/64
 [58] **Field of Search** 128/80 C, 87, 88; D24/64

3,742,517 7/1973 Bednarczuk 128/80 C
 4,090,508 5/1978 Gaylord, Jr. 128/80 C
 4,312,335 1/1982 Daniell, Jr. 128/80 C
 4,340,041 7/1982 Frank .

Primary Examiner—Bernard Ansher
Attorney, Agent, or Firm—Charles W. McHugh

[57] **CLAIM**

The ornamental design for an articulate knee brace, as shown and described.

DESCRIPTION

FIG. 1 is a side perspective view of an articulate knee brace showing my new design;
 FIG. 2 is a top plan view thereof;
 FIG. 3 is a bottom plan view thereof;
 FIG. 4 is a front elevation thereof;
 FIG. 5 is a left side elevation thereof;
 FIG. 6 is a rear elevation thereof; and
 FIG. 7 is a right side elevation thereof.

[56] **References Cited**
U.S. PATENT DOCUMENTS
 D. 259,058 4/1981 Marshall D24/64
 D. 265,248 6/1982 Grigorieff D24/64

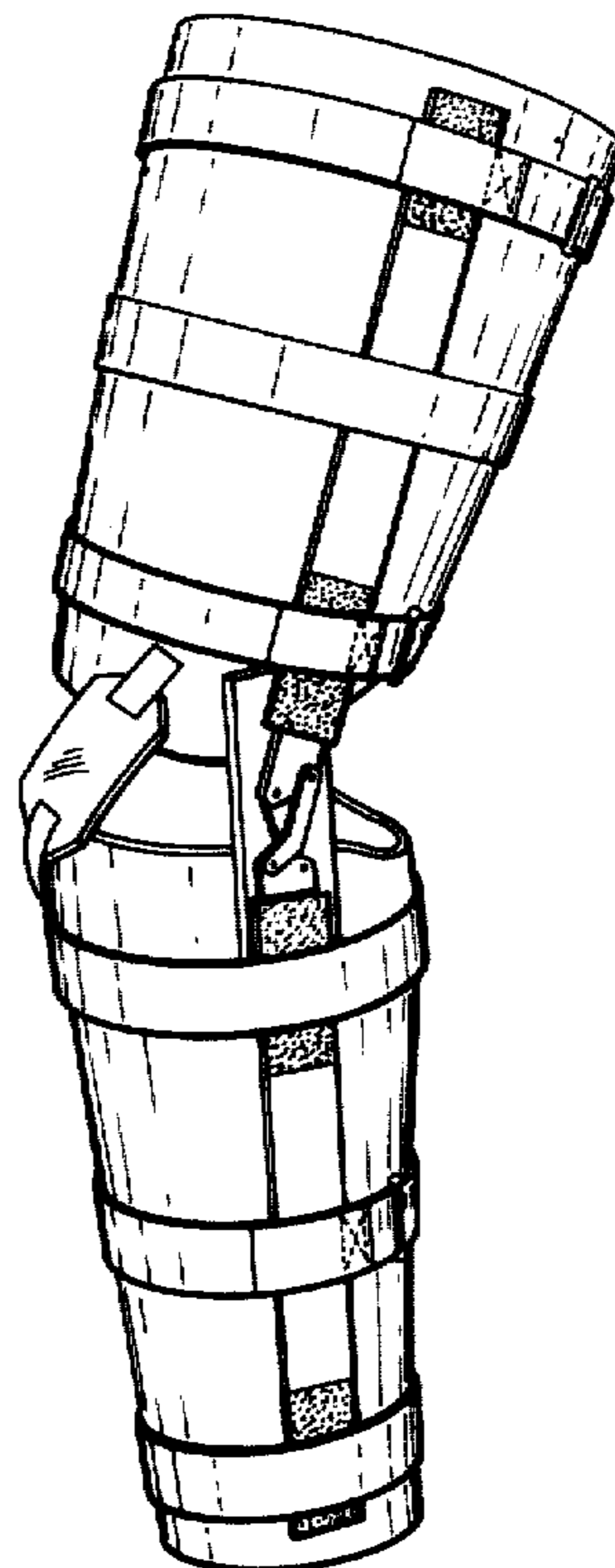

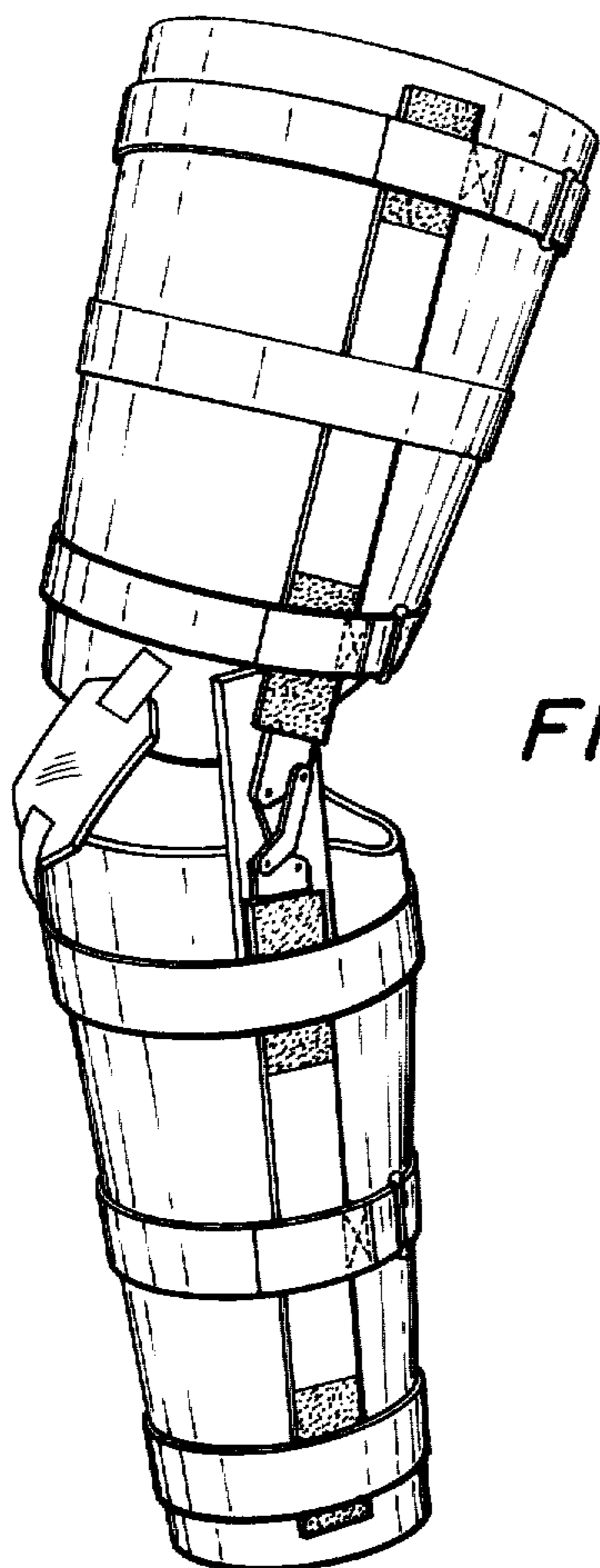

FIG. 1

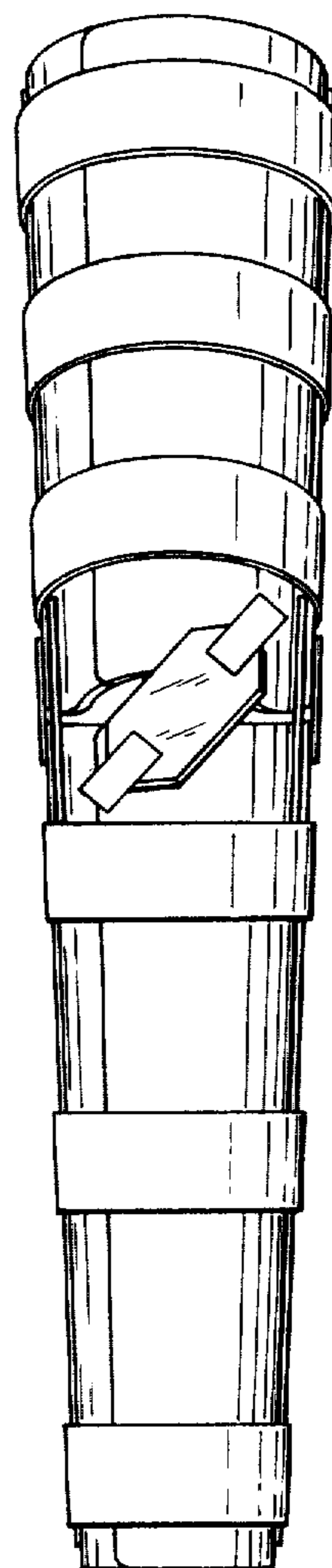

FIG. 4

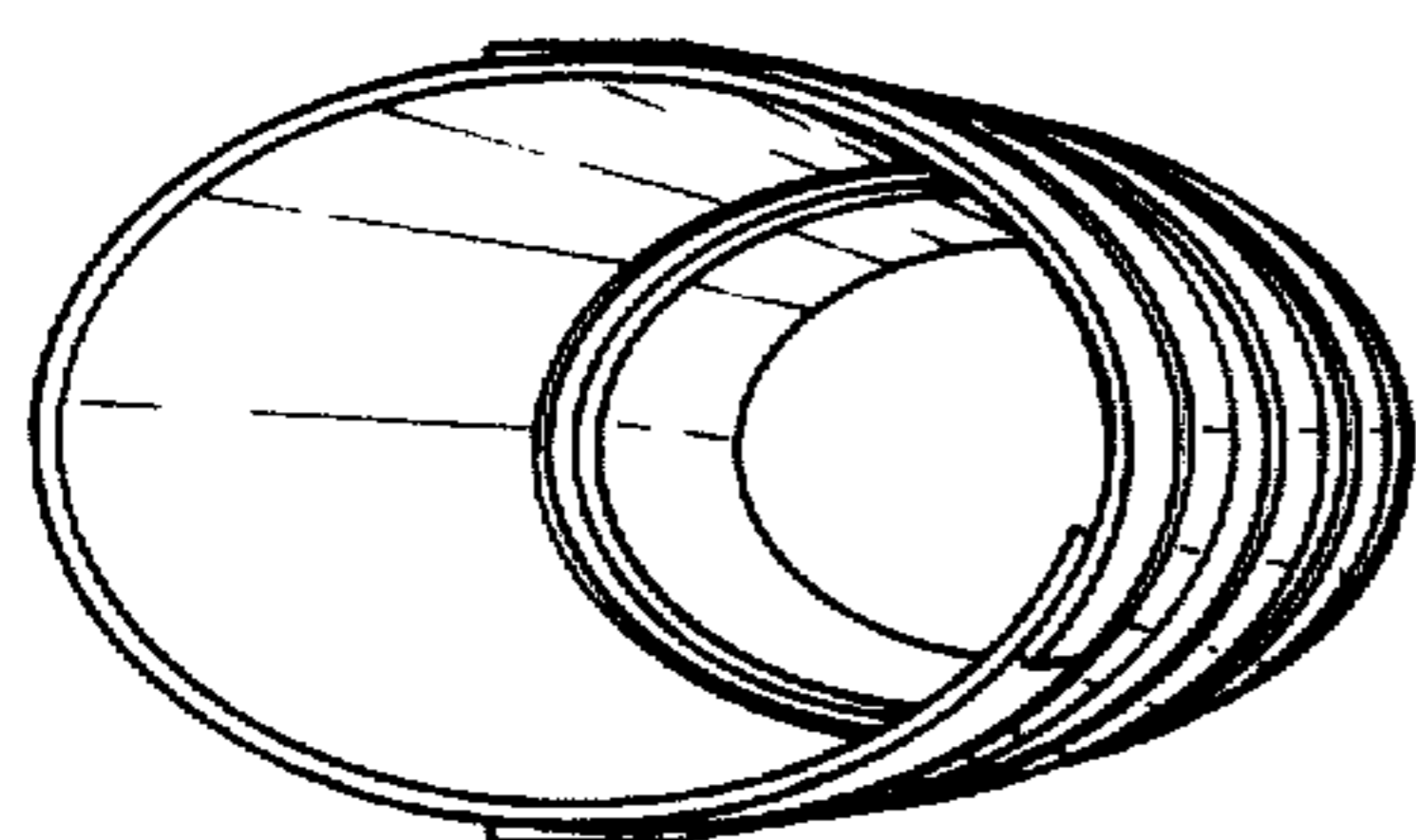

FIG. 2

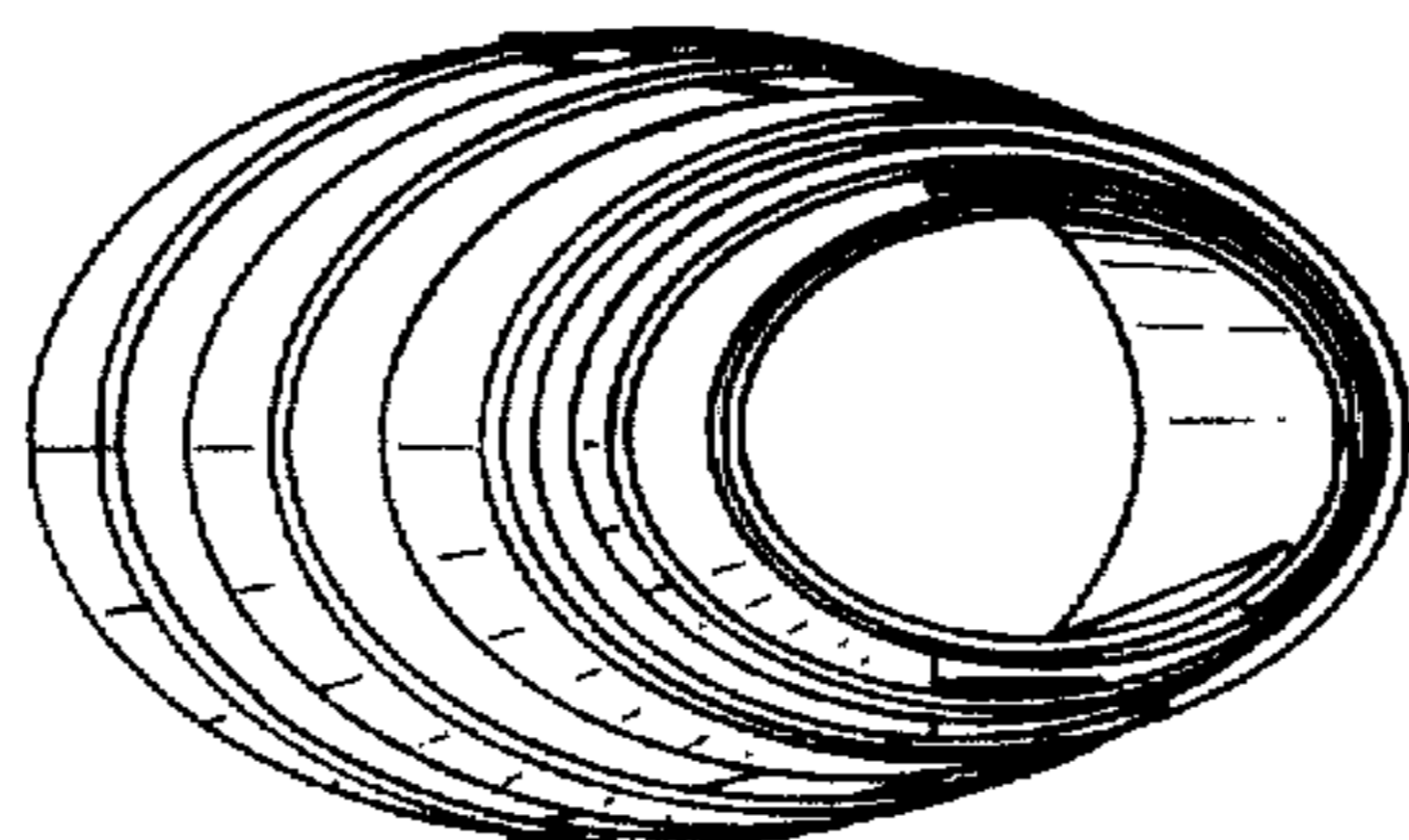

FIG. 3

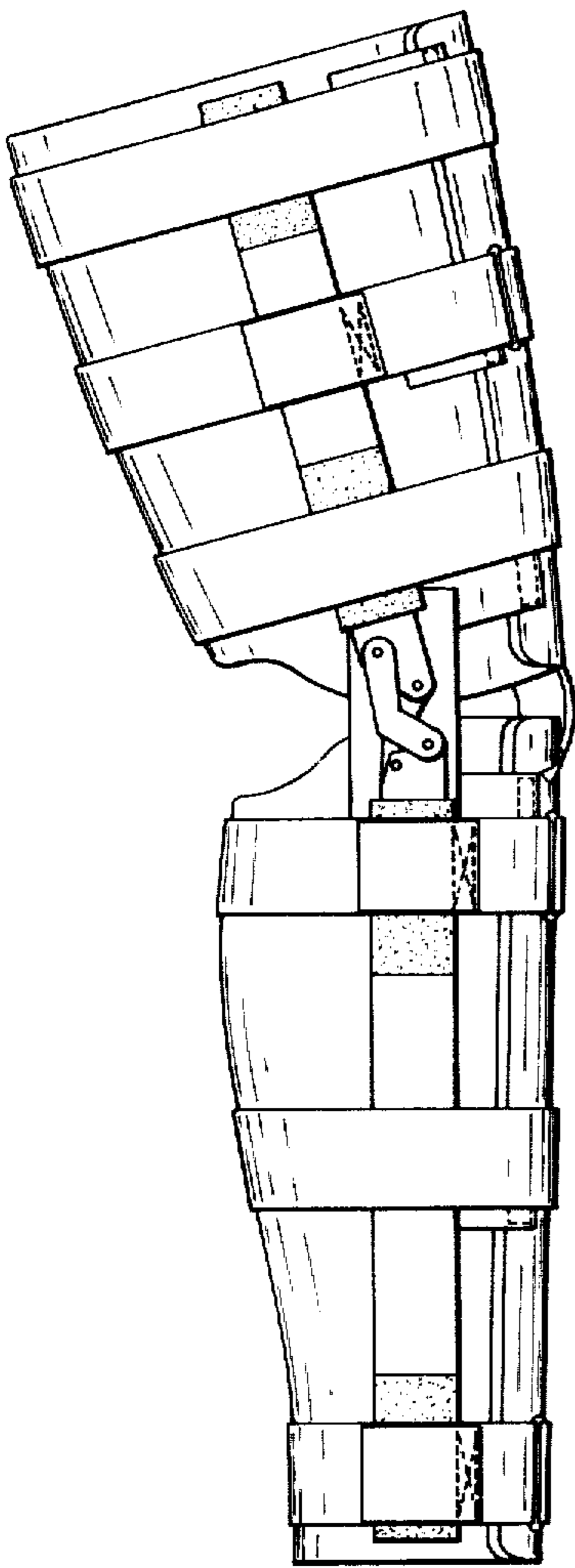

FIG. 5

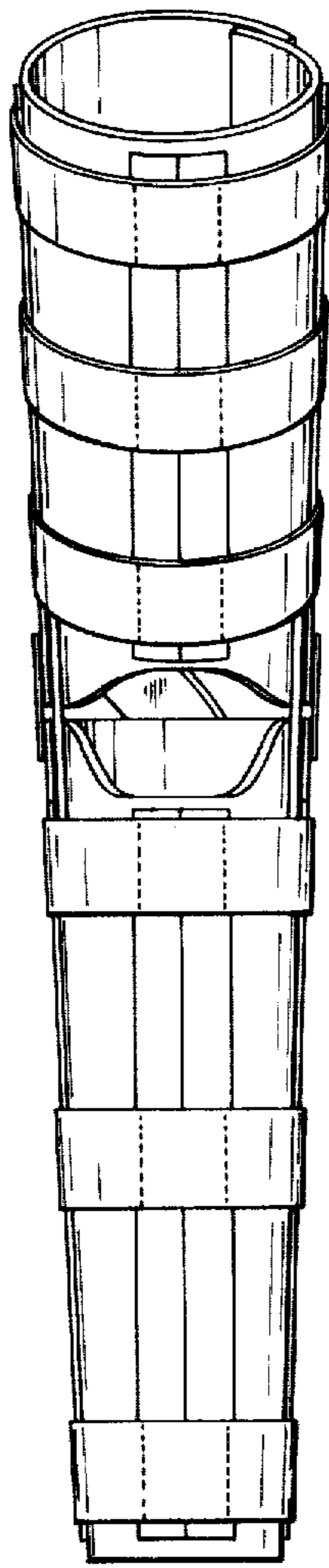

FIG. 6

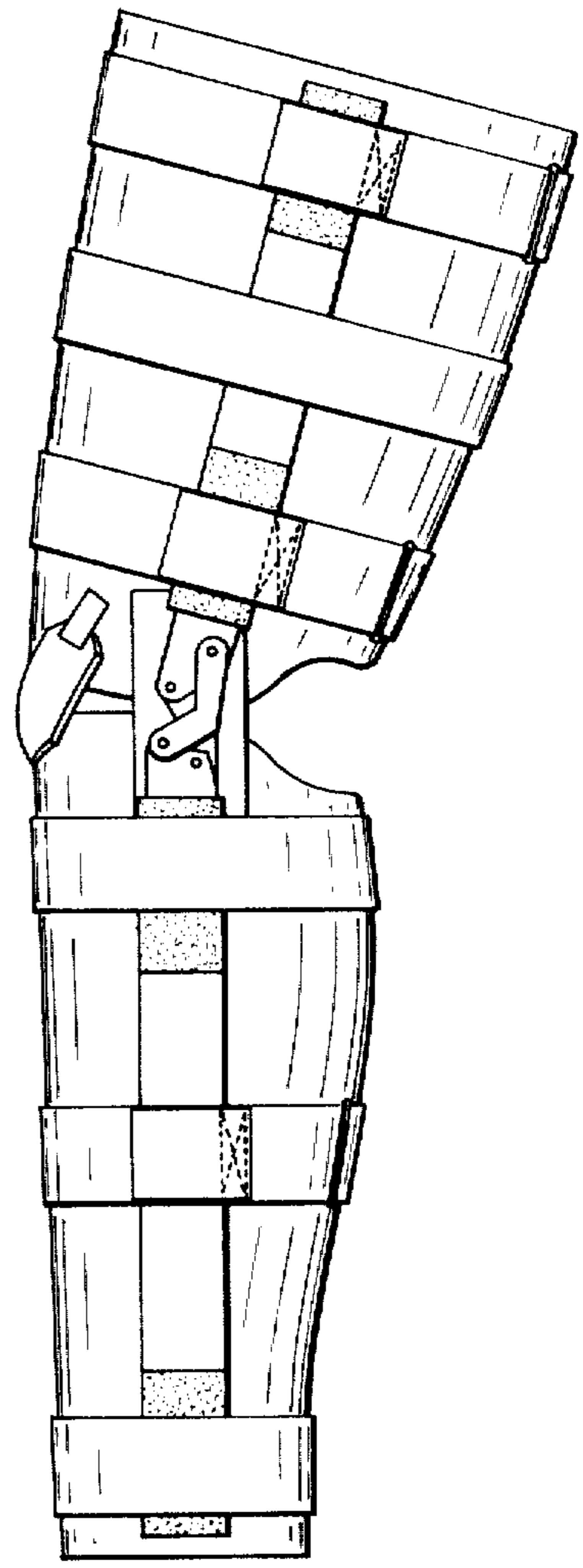

FIG. 7