

[54] HAIR CURLING IRON

[75] Inventor: Robert Oberheim, Liederbach, Fed. Rep. of Germany

[73] Assignee: Braun Aktiengesellschaft, Kronberg, Fed. Rep. of Germany

[\*\*] Term: 14 Years

[21] Appl. No.: 274,012

[22] Filed: Jun. 15, 1981

[30] Foreign Application Priority Data

Jan. 8, 1981 [DE] Fed. Rep. of Germany ..... 73 MR 8939

[51] Int. Cl. .... D28-03

[52] U.S. Cl. .... D28/35; D28/26

[58] Field of Search ..... D28/9, 10, 26, 35, 99, D28/37; 219/222, 225; 132/31 R, 32 R, 39 R, 37 A

[56] References Cited

U.S. PATENT DOCUMENTS

D. 240,466 7/1976 Rinaldi ..... D28/35

D. 257,595 12/1980 Bullock ..... D28/37

OTHER PUBLICATIONS

*HFD-Retailing Home Furnishings*, 10/20/80, Section One, p. 77-Curling Brushes at center. *Modern Salon*, 6/1980, inside front cover-Helene Curtis Shaping Iron at bottom.

Primary Examiner—Louis S. Zarfes  
Attorney, Agent, or Firm—Raymond J. De Vellis

[57] CLAIM

The ornamental design for a hair curling iron, substantially as shown and described.

DESCRIPTION

FIG. 1 is a front elevational view of a hair curling iron showing my new design;  
FIG. 2 is a rear elevational view thereof;  
FIG. 3 is a left side elevational view thereof;  
FIG. 4 is a right side elevational view thereof;  
FIG. 5 is a top plan view thereof;  
FIG. 6 is a bottom plan thereof;  
FIG. 7 is a right front perspective view of the hair curling iron shown in FIG. 1.

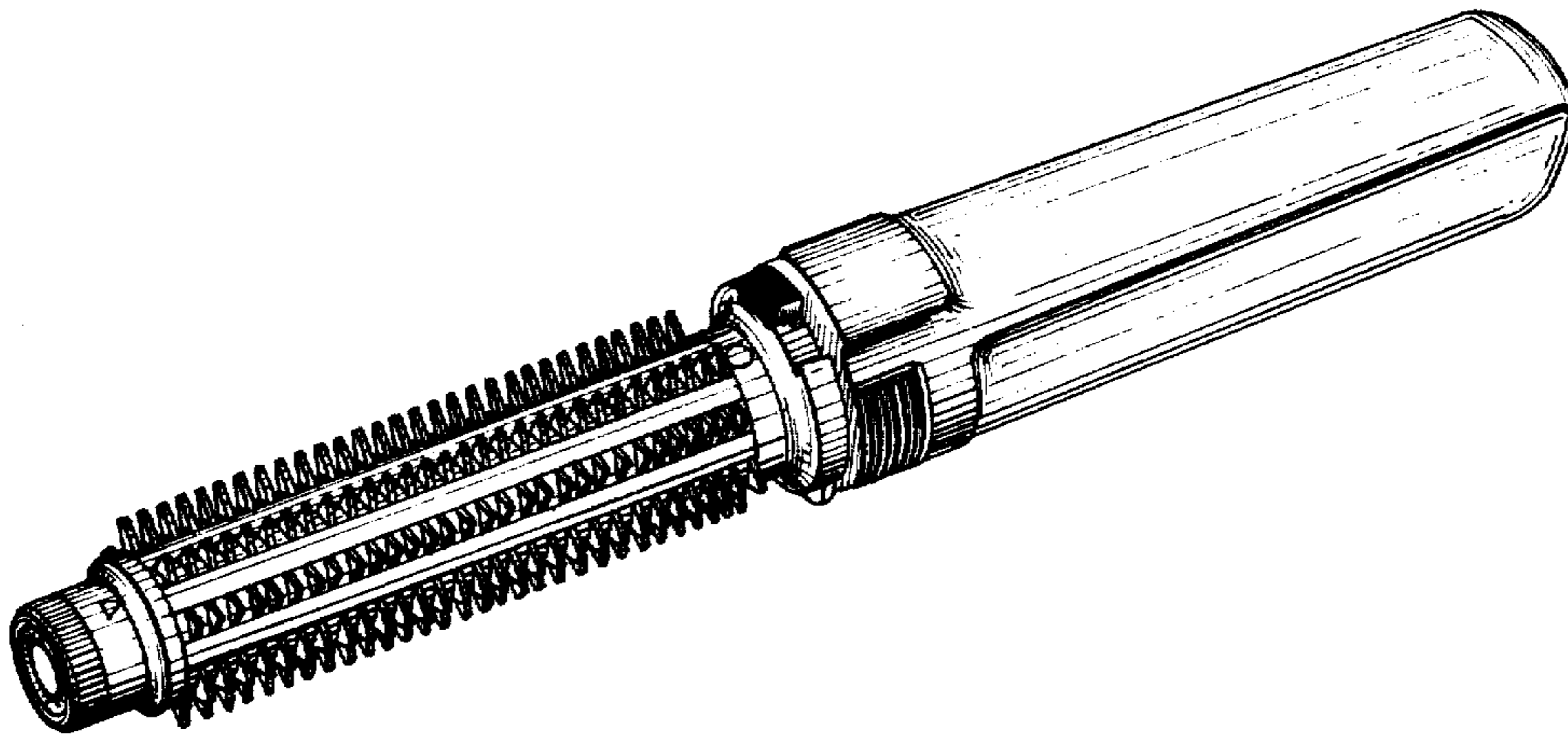

*Fig. 1*

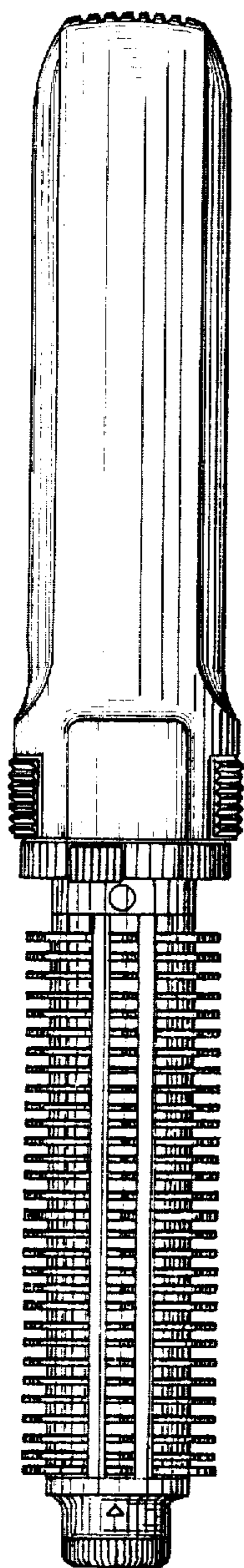

*Fig. 2*

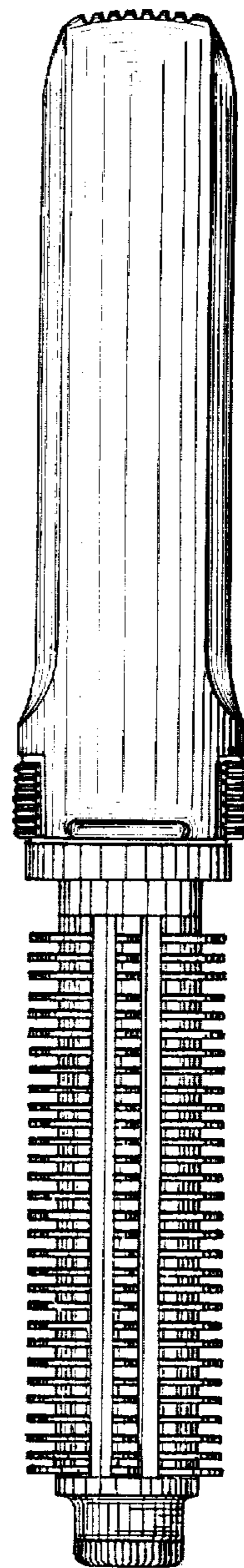

Fig. 3

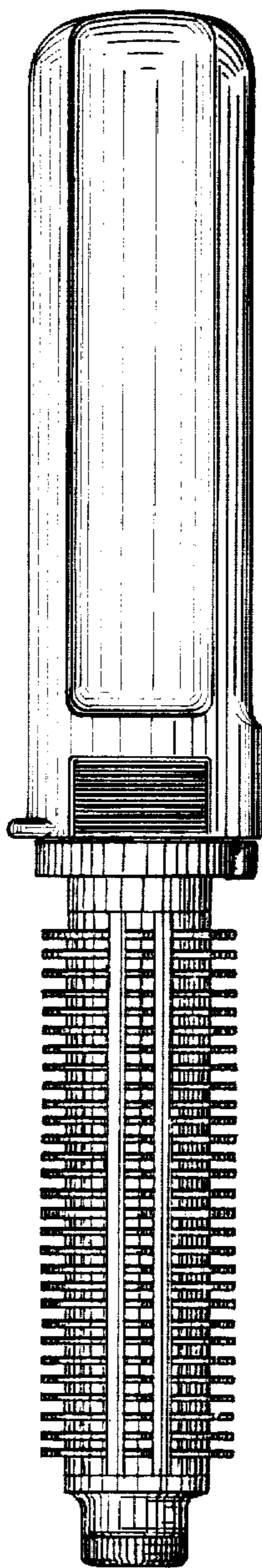

Fig. 4

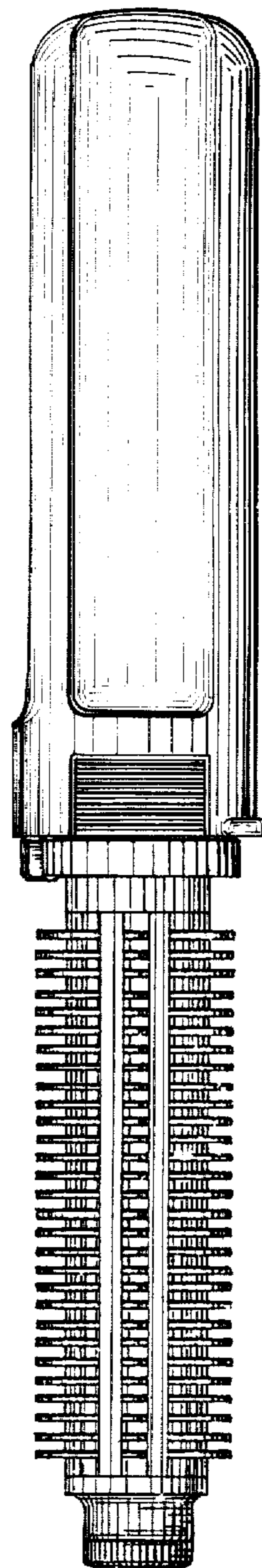

Fig. 5

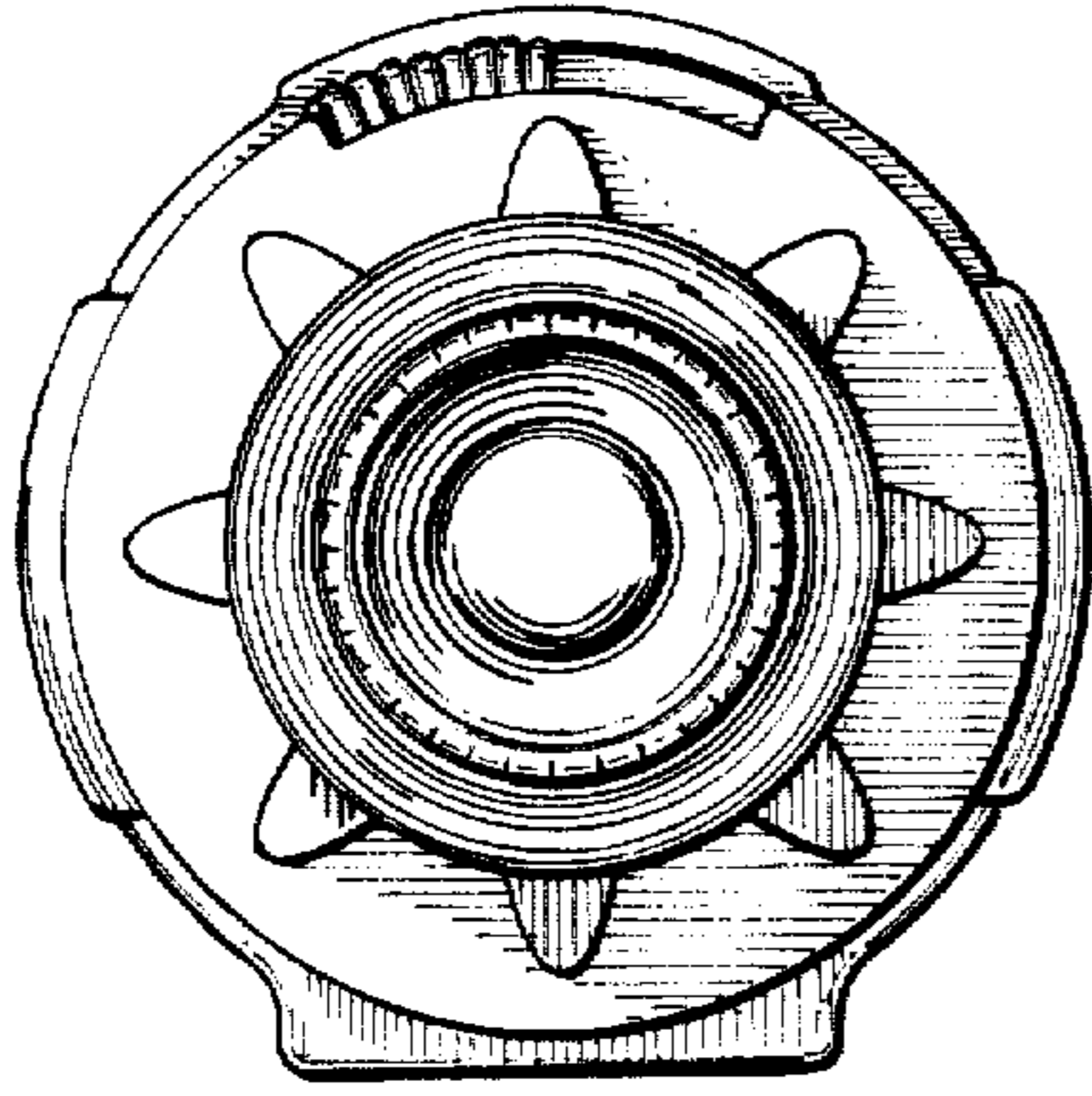

Fig. 6

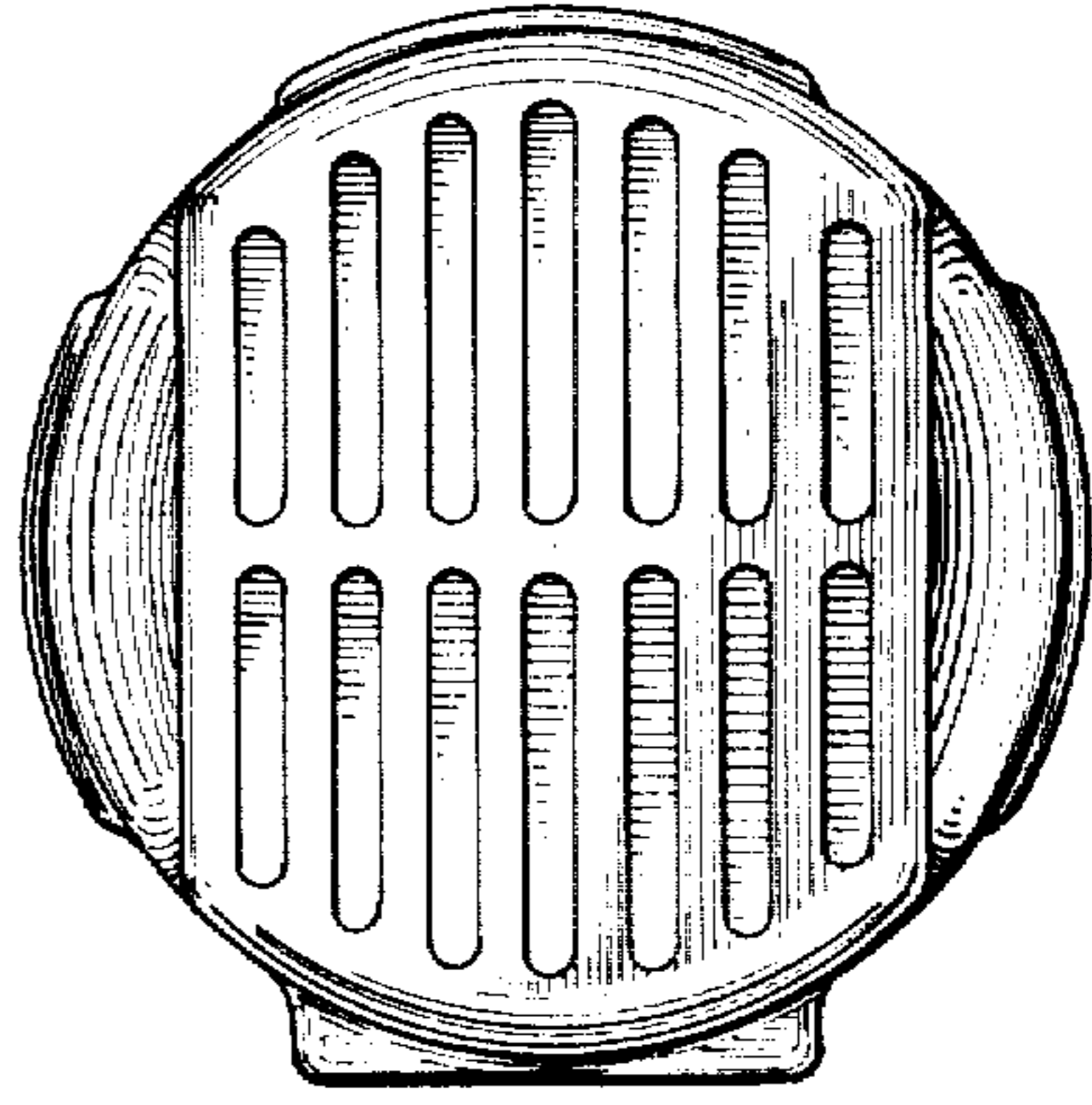

Fig. 7

