

[54] ELECTRONIC DIGITAL CONTROL PANEL AND DISPLAY UNIT

[75] Inventor: Ettore Sottsass, Milan, Italy
[73] Assignee: Mandelli S.p.A., Piacenza, Italy
[**] Term: 14 Years

[21] Appl. No.: 248,367
[22] Filed: Mar. 27, 1981

[30] Foreign Application Priority Data
Oct. 2, 1980 [IT] Italy 22978/80[U]

[51] Int. Cl. D13-02; D14-02
[52] U.S. Cl. D14/106; D13/12
[58] Field of Search D15/138; D13/12, 32, D13/40, 41; D14/100, 102, 103, 106, 107, 114, 115; 340/365 R; 361/331, 332, 334, 346, 381, 380, 384, 390-395, 399; 200/5 R, 5 A

[56] References Cited
U.S. PATENT DOCUMENTS
D. 210,284 2/1968 Kerwin D14/103 X

D. 247,173 2/1978 Peter et al. D14/106

Primary Examiner—Susan J. Lucas
Attorney, Agent, or Firm—Young & Thompson

[57] CLAIM

The ornamental design for an electronic digital control panel and display unit, as shown and described.

DESCRIPTION

FIG. 1 is a perspective view of a combined electronic digital control panel and display unit showing my new design;
FIG. 2 is a front view of the panel and display unit of FIG. 1 on an enlarged scale;
FIG. 3 is a rear view of the panel and display unit of FIG. 1 on an enlarged scale;
FIG. 4 is a left side view of the panel and display unit of FIG. 1 on an enlarged scale;
FIG. 5 is a right side view of the panel and display unit of FIG. 1 on an enlarged scale;
FIG. 6 is a top plan view of the panel and display unit of FIG. 1 on an enlarged scale; and
FIG. 7 is a bottom plan view of the panel and display unit of FIG. 1 on an enlarged scale.

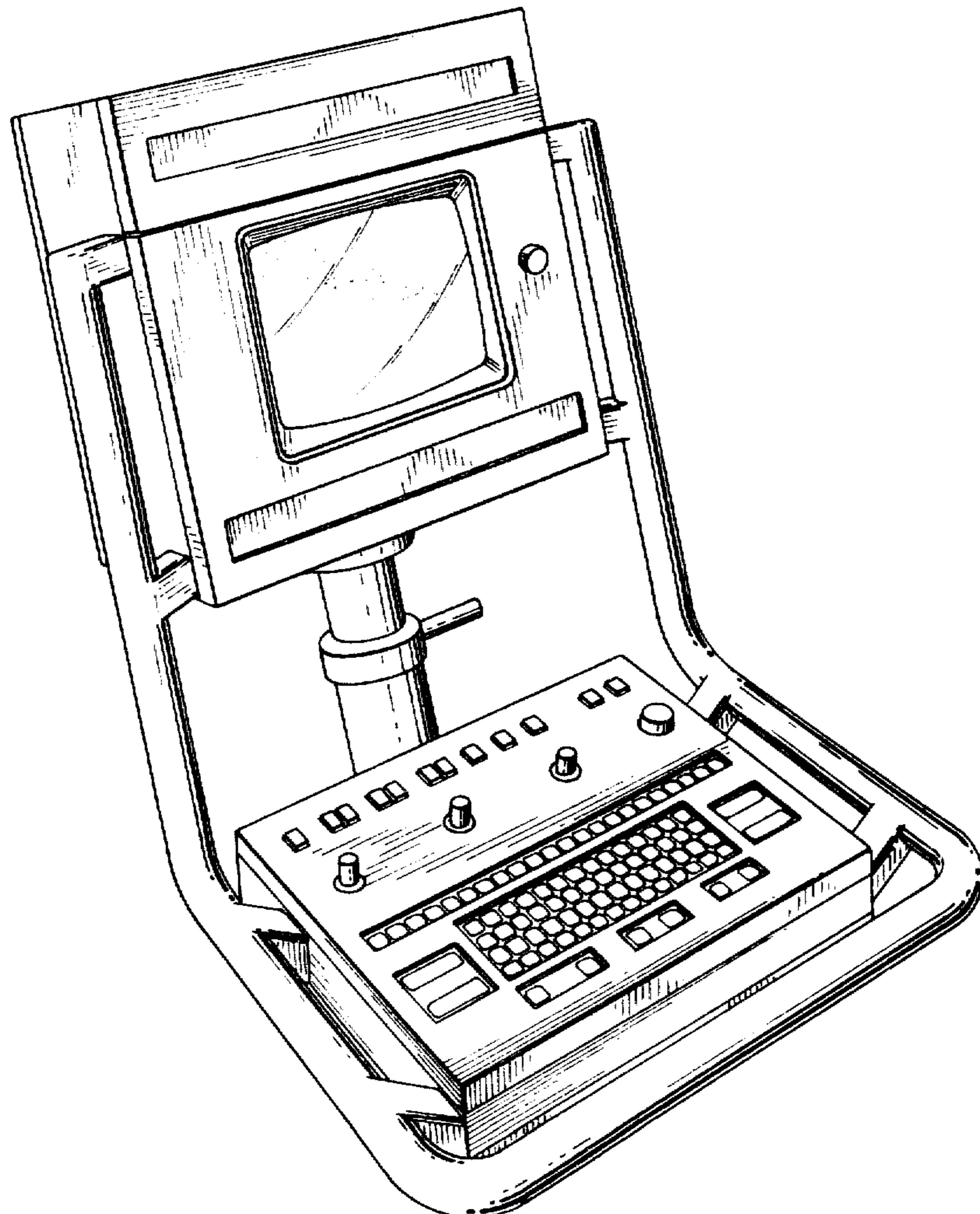

FIG. 2

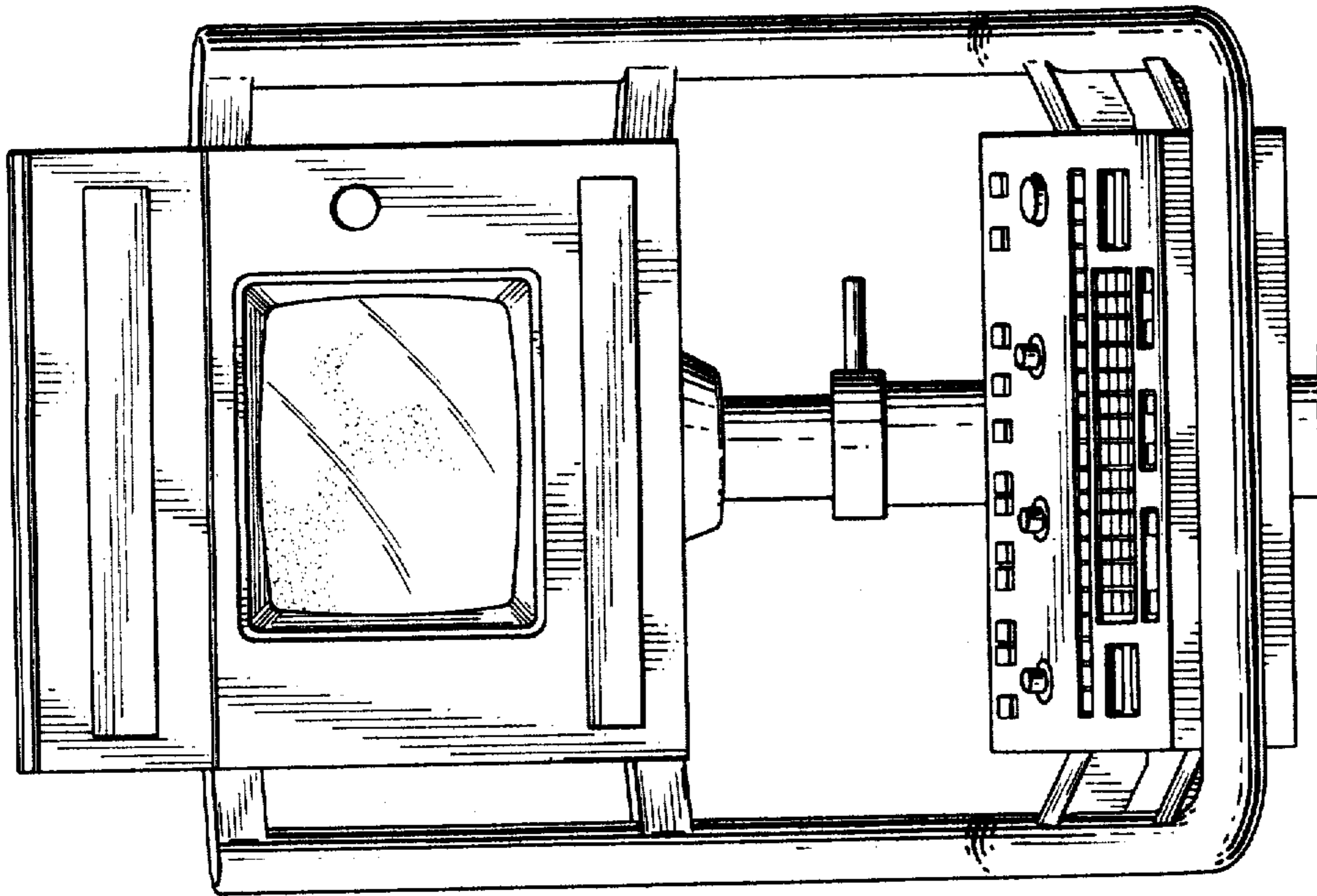

FIG. 1

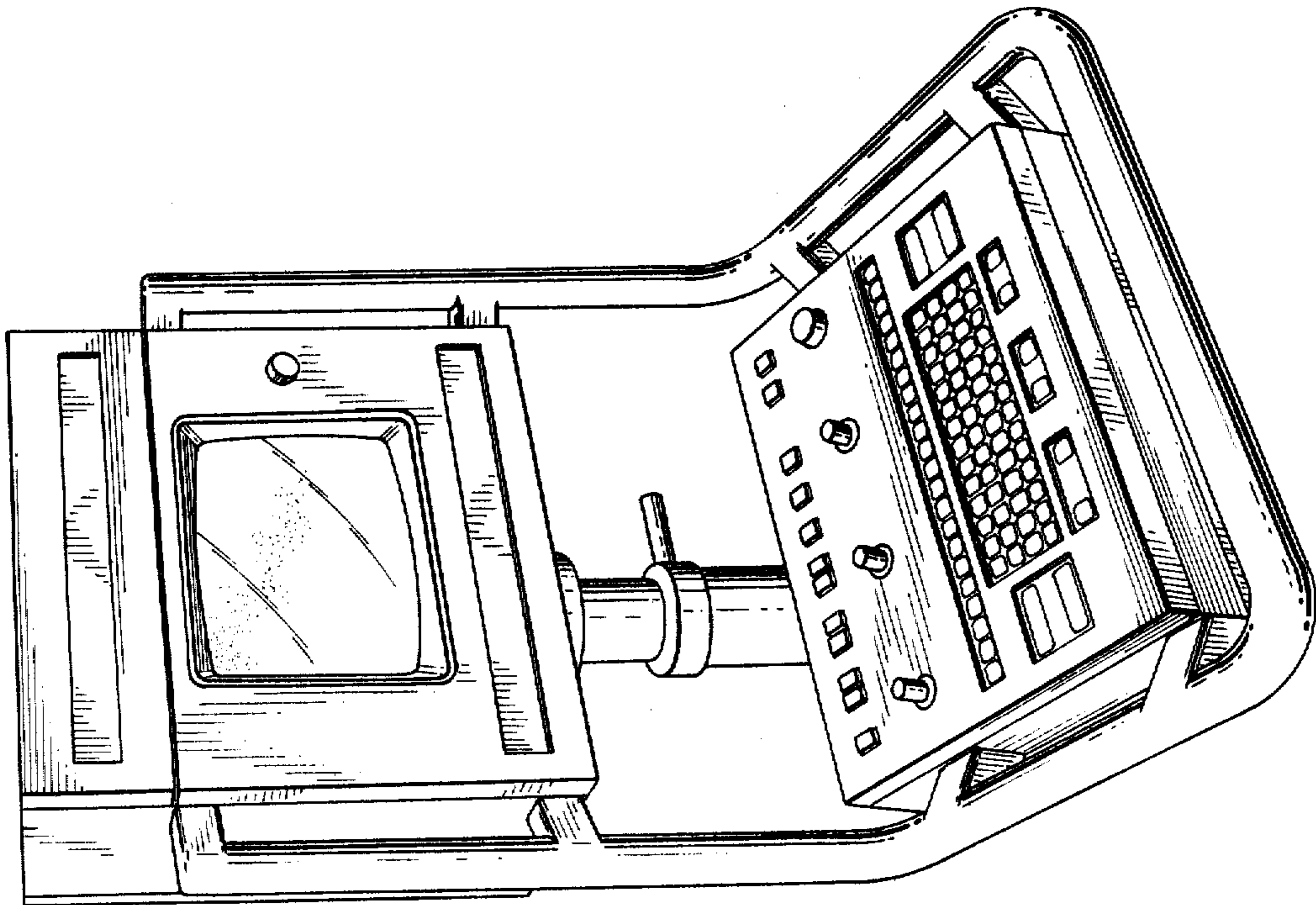

FIG. 4

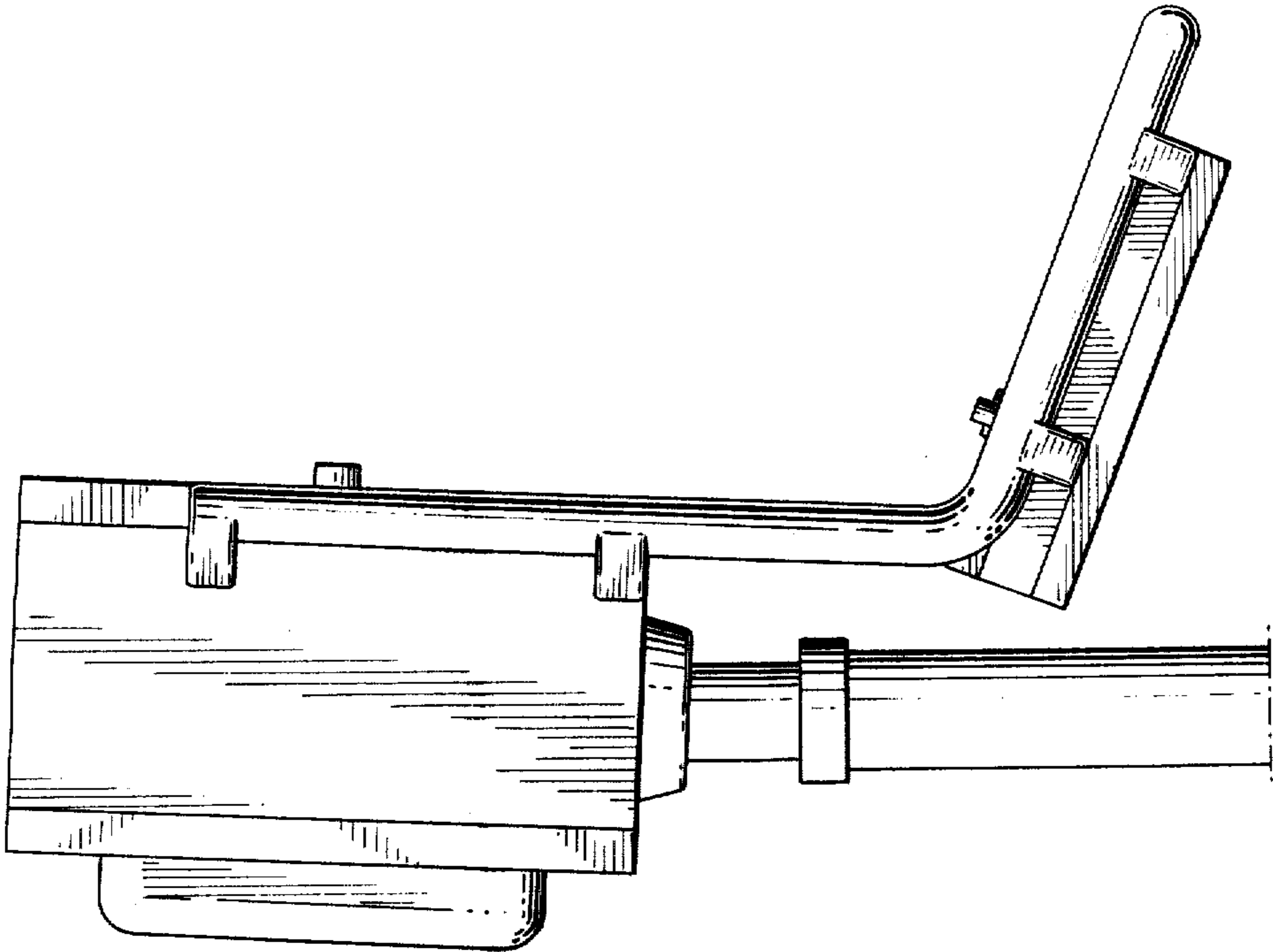

FIG. 3

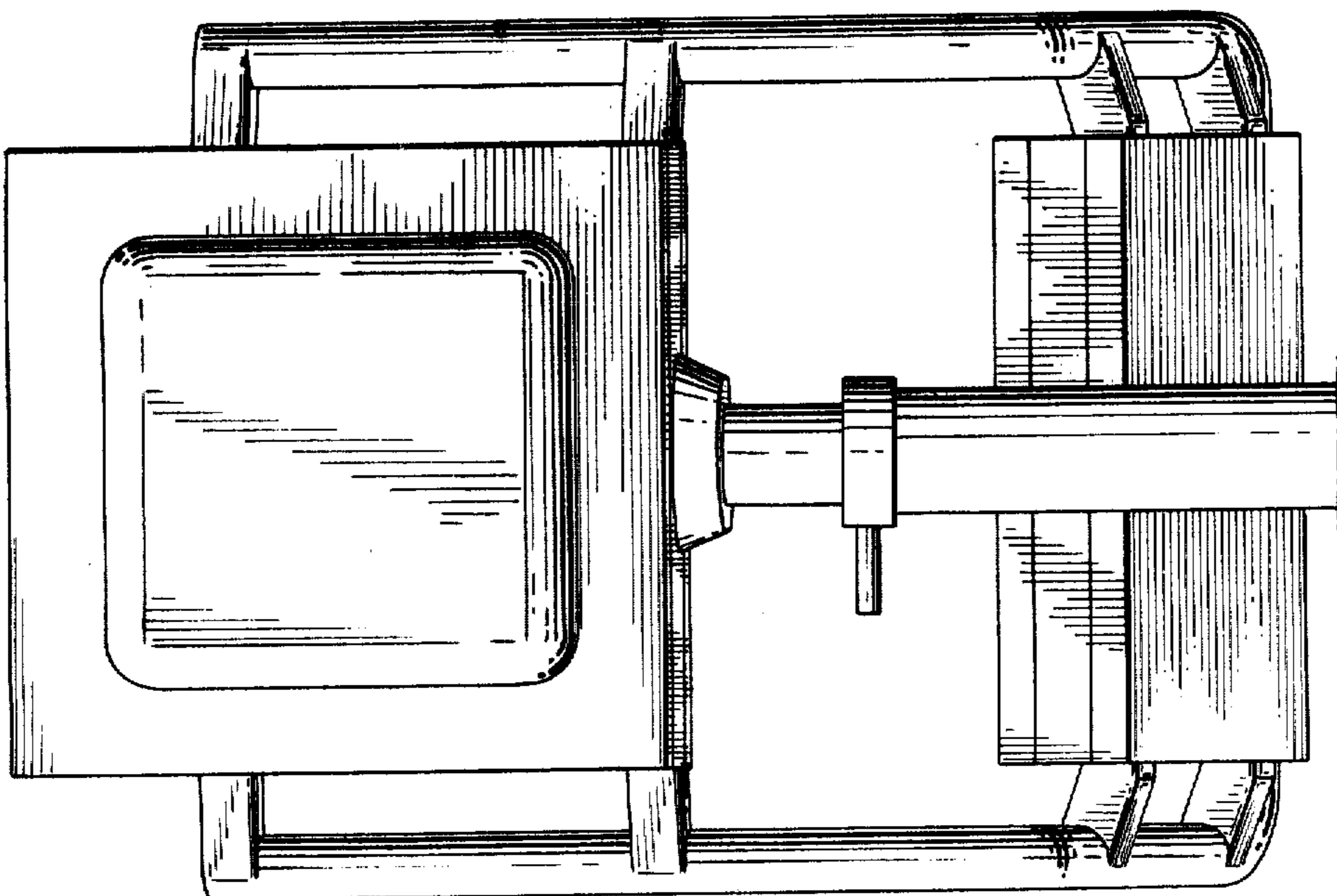

FIG. 6

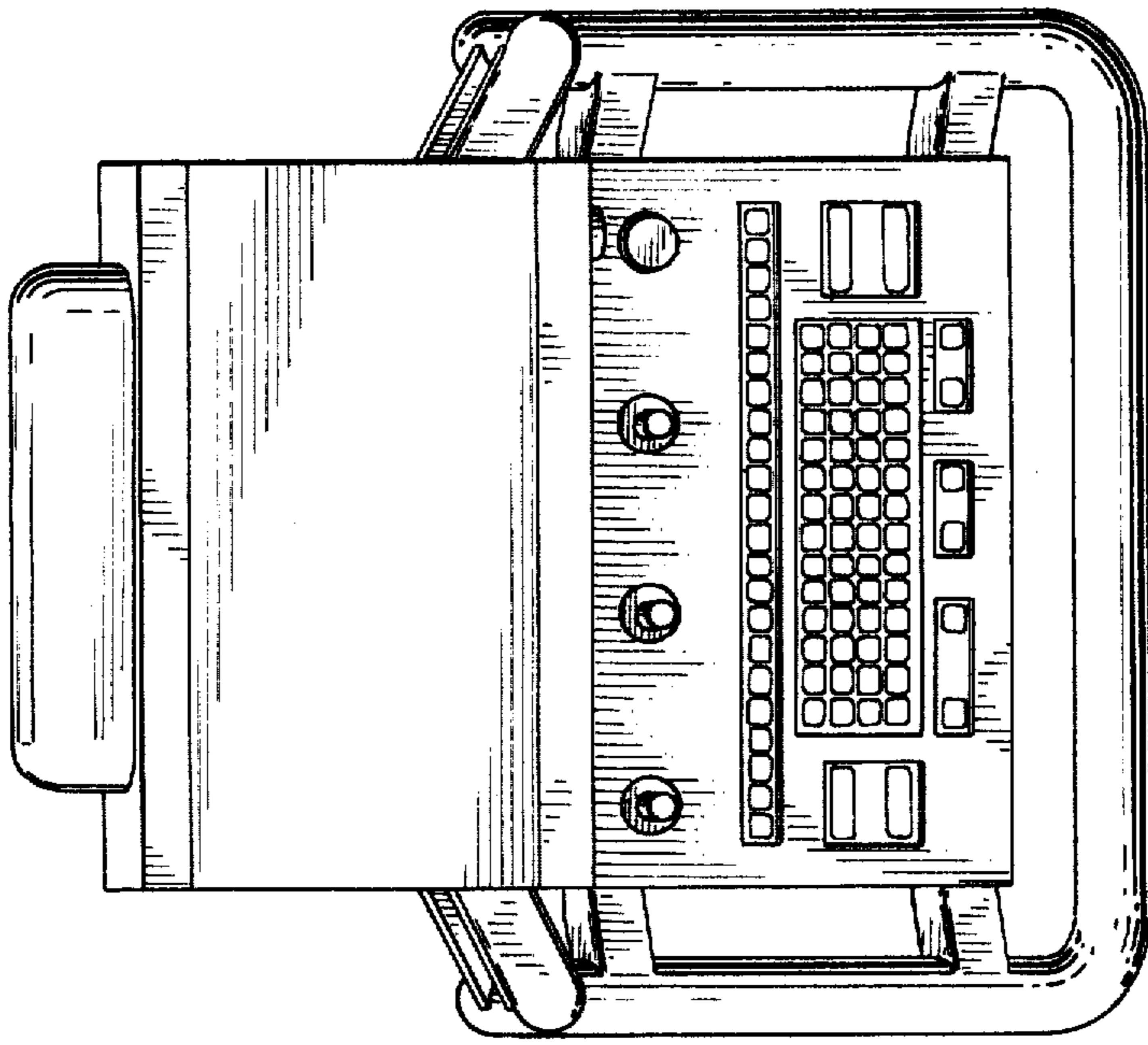

FIG. 5

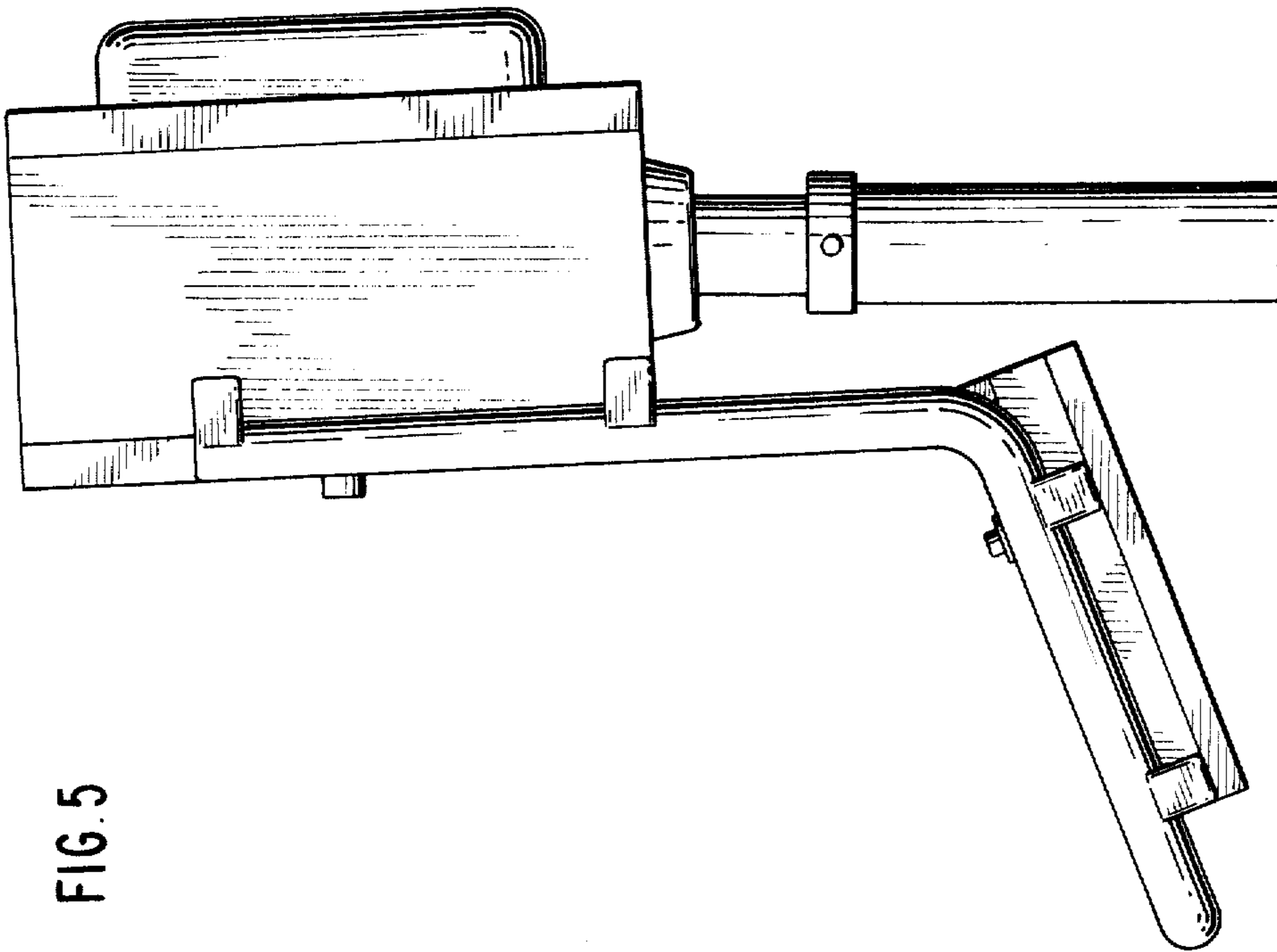
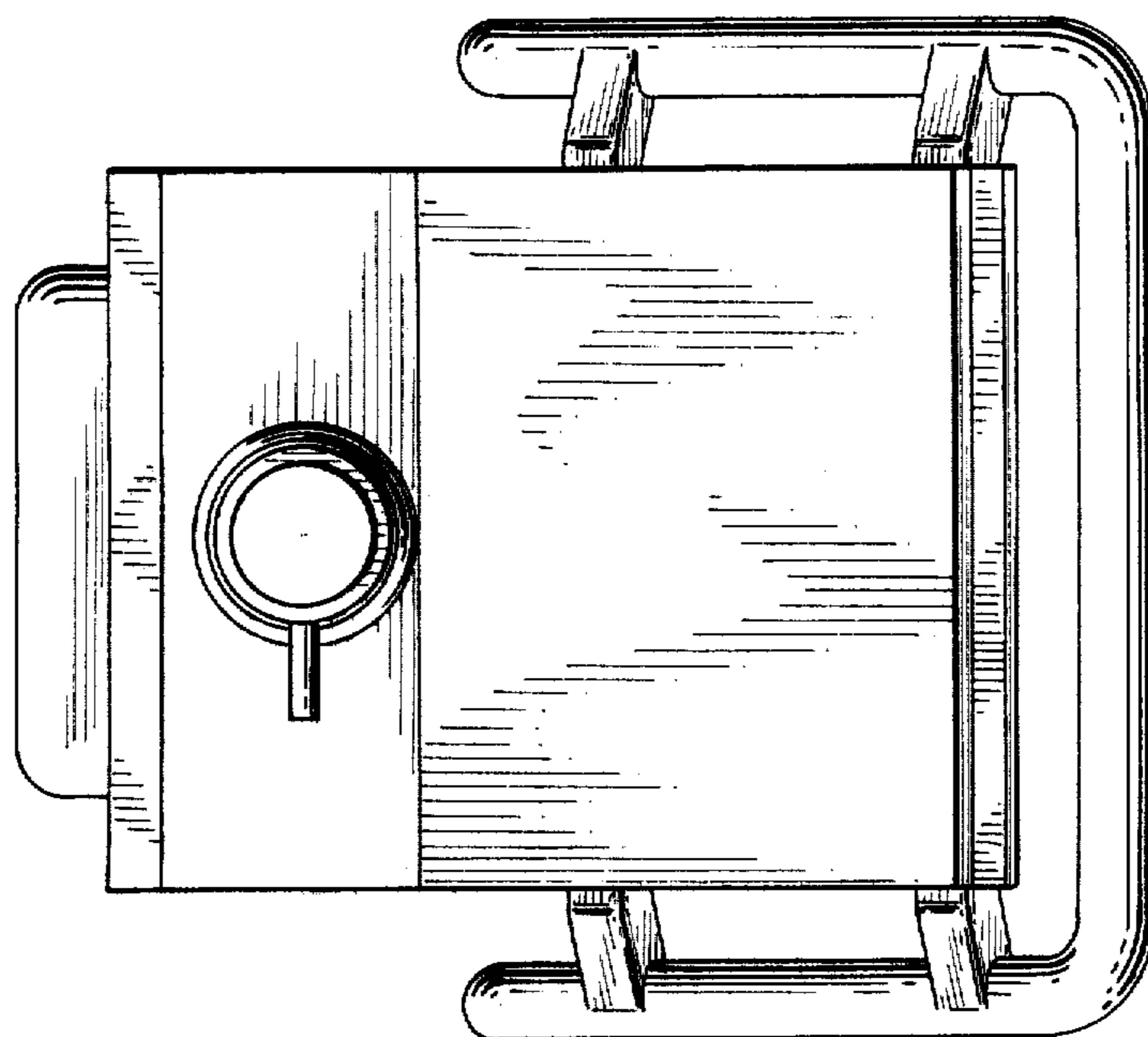

FIG. 7



UNITED STATES PATENT AND TRADEMARK OFFICE
CERTIFICATE OF CORRECTION

PATENT NO. : Des. 269,271
DATED : June 7, 1983
INVENTOR(S) : Ettore Sottsass

It is certified that error appears in the above—identified patent and that said Letters Patent is hereby corrected as shown below:

On the title page, under "[30] Foreign Application Priority Data", change "22978/80" to --22979/80--.

Signed and Sealed this

Eighteenth Day of September 1984

[SEAL]

Attest:

Attesting Officer

GERALD J. MOSSINGHOFF

Commissioner of Patents and Trademarks