

[54] COMBINED SPA TABLE AND SUPPORT THEREFOR

- [75] Inventors: Donald W. Doman, Janesville; Alfred W. Elsner, Plymouth, both of Wis.
- [73] Assignee: Kohler Co., Kohler, Wis.
- [**] Term: 14 Years
- [21] Appl. No.: 370,628
- [22] Filed: Apr. 22, 1982

Related U.S. Application Data

- [62] Division of Ser. No. 172,458, Jul. 25, 1980, Pat. No. Des. 266,638.
- [51] Int. Cl. D6-06
- [52] U.S. Cl. D6/20; D6/27; D24/38
- [58] Field of Search D6/20, 27, 177, 146; D24/38; D7/21, 71, 37, 108, 109

References Cited

U.S. PATENT DOCUMENTS

D. 203,603	2/1966	Poletika	D6/177
D. 219,108	11/1970	Lange	D6/146
D. 232,793	9/1974	Marwood	D6/146
D. 234,157	1/1975	McQuarrie	D6/20 X
D. 239,673	4/1976	Zieler	D6/146
D. 258,023	1/1981	Ackeret	D6/20 X
3,367,525	2/1968	Elder	D7/71 X

OTHER PUBLICATIONS

Cross Reference to U.S. Ser. No. 172,477, filed Jul. 25, 1980.
 Cross Reference to "Combined Spa Table & Bathing Spa," a filed U.S. application, mailed Aug. 25, 1980.
 "Tub & Spa Gallery," p. 49, Gill Gillespie designed spa. Islander Spas flyer, 1979, "The Premier Sea Shell Collection".
 Sunfloat Advertisement, 1979, "Now the Most Popular Game in the Country Can be Played in the Water".

Primary Examiner—Bernard Ansher
 Attorney, Agent, or Firm—Quarles & Brady

CLAIM

[57] The ornamental design for a combined spa table and support therefor, as shown.

DESCRIPTION

FIG. 1 is a perspective view of a combined spa table and support therefor showing our new design;
 FIG. 2 is a side elevational view thereof;
 FIG. 3 is a cross sectional view thereof taken along plane 3—3 of FIG. 2 in the direction of the arrows;
 FIG. 4 is a top plan view thereof;
 FIG. 5 is a bottom plan view of the spa table portion thereof, the support having been removed for ease of illustration; and
 FIG. 6 is a right end elevational view of the spa table portion thereof, the support having been removed for ease of illustration.

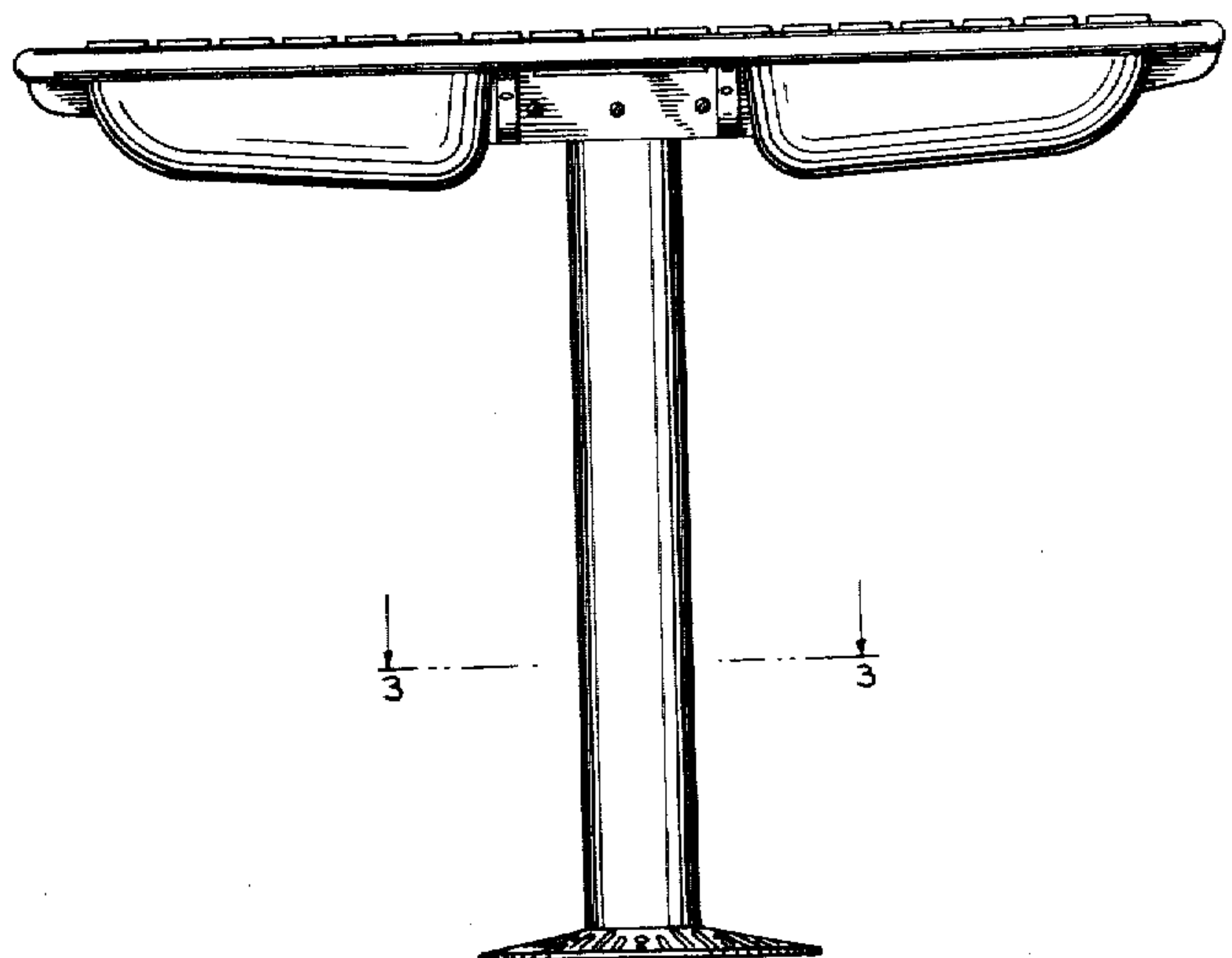
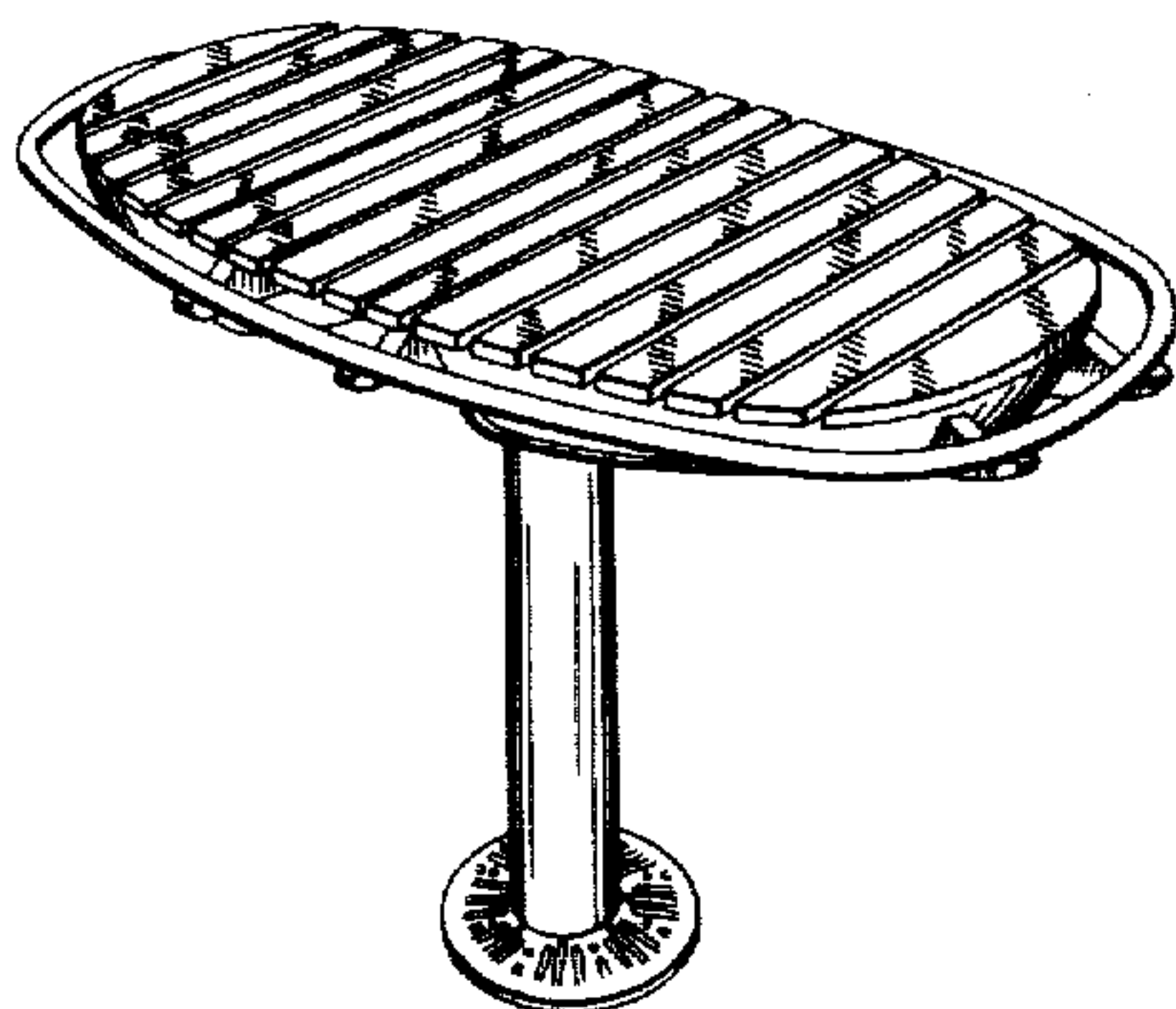

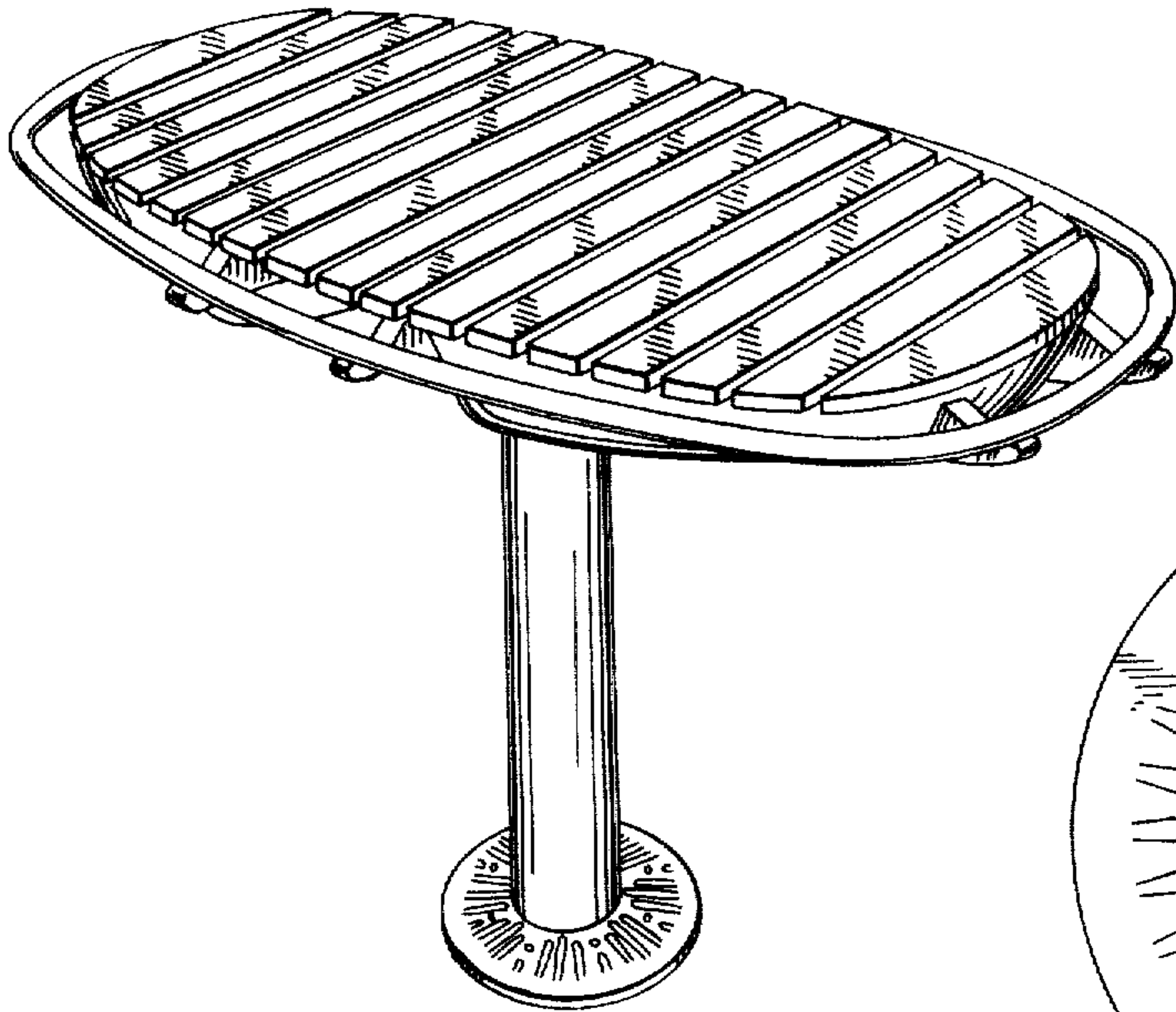

FIG. 1

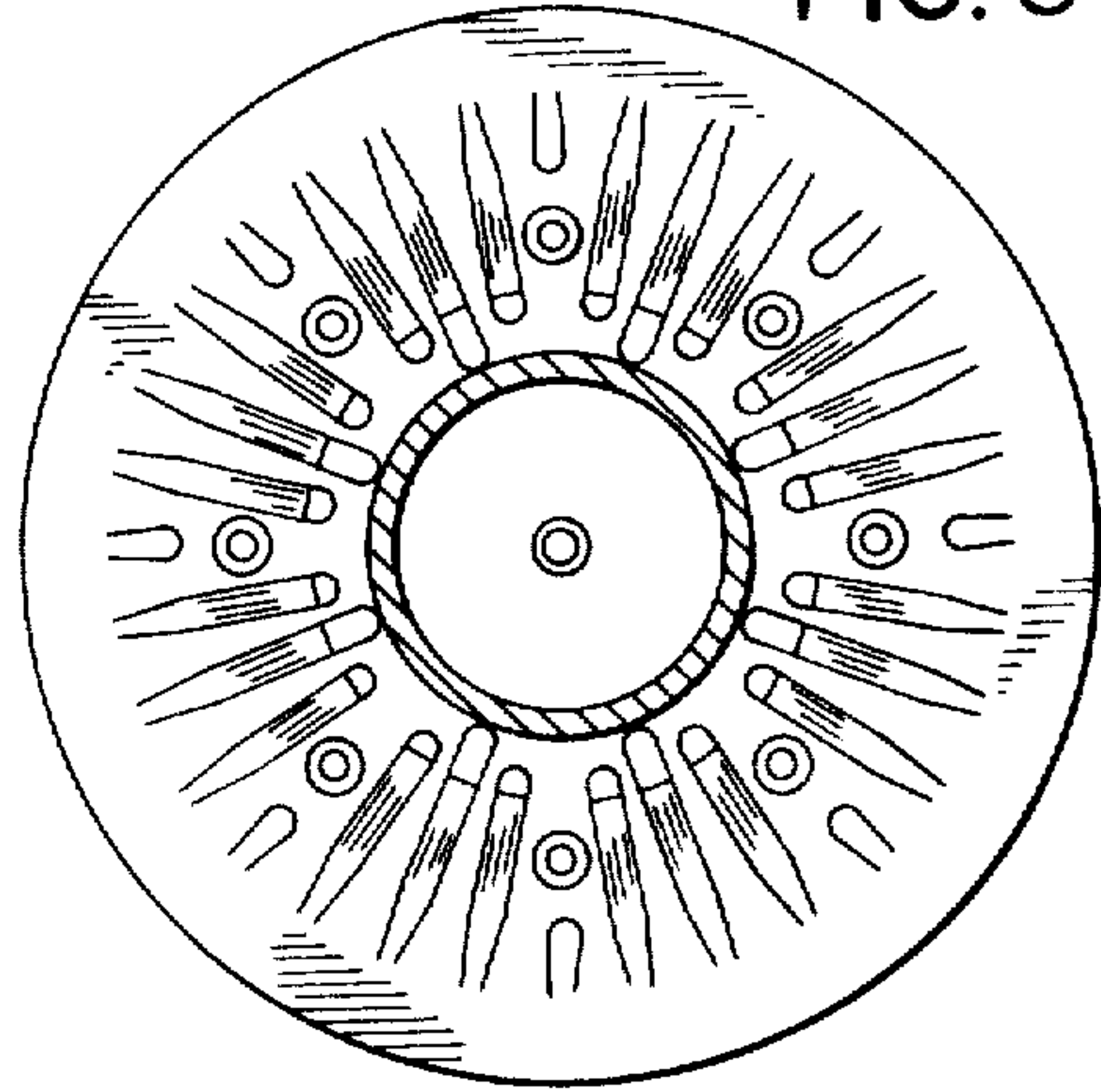

FIG. 3

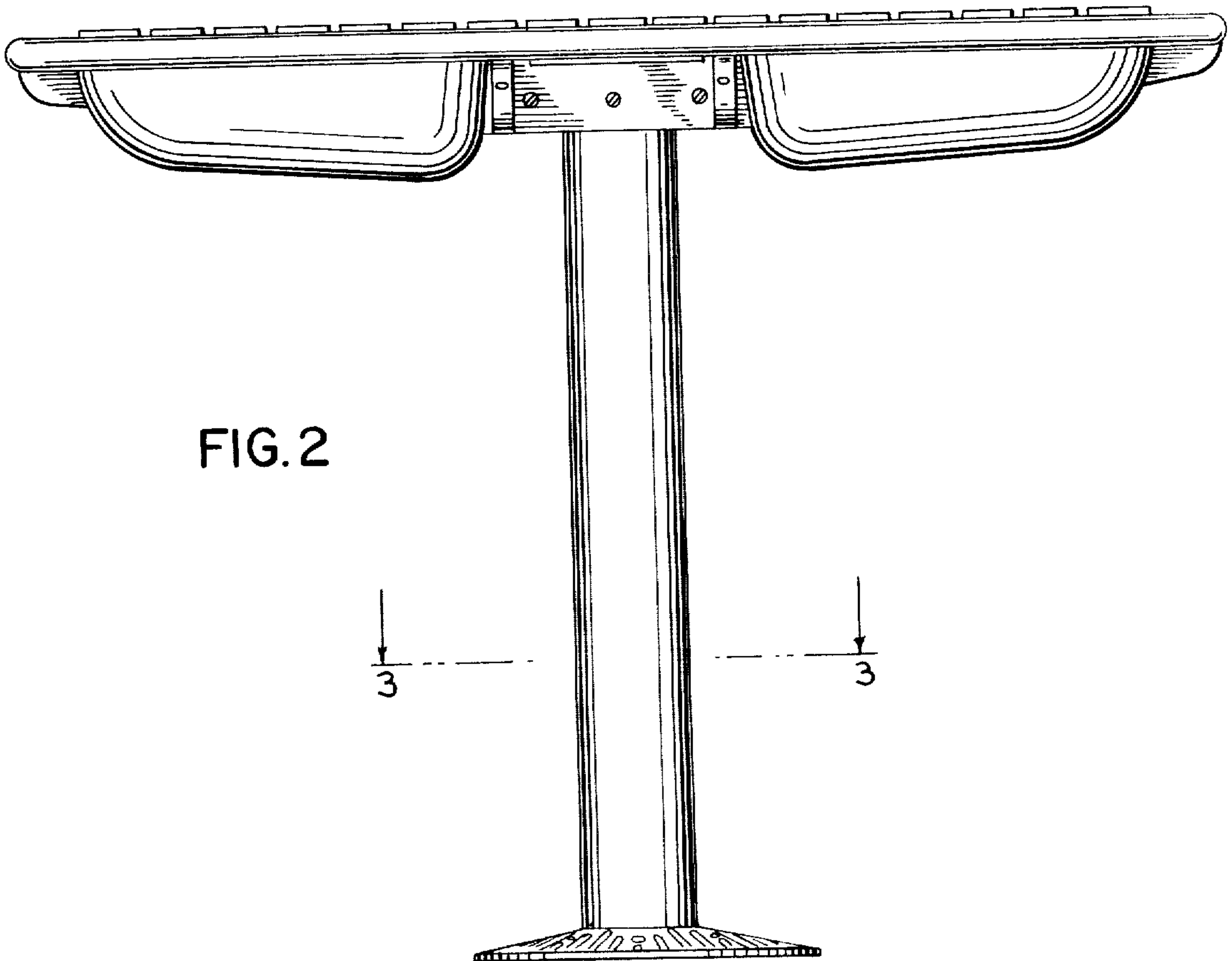

FIG. 2

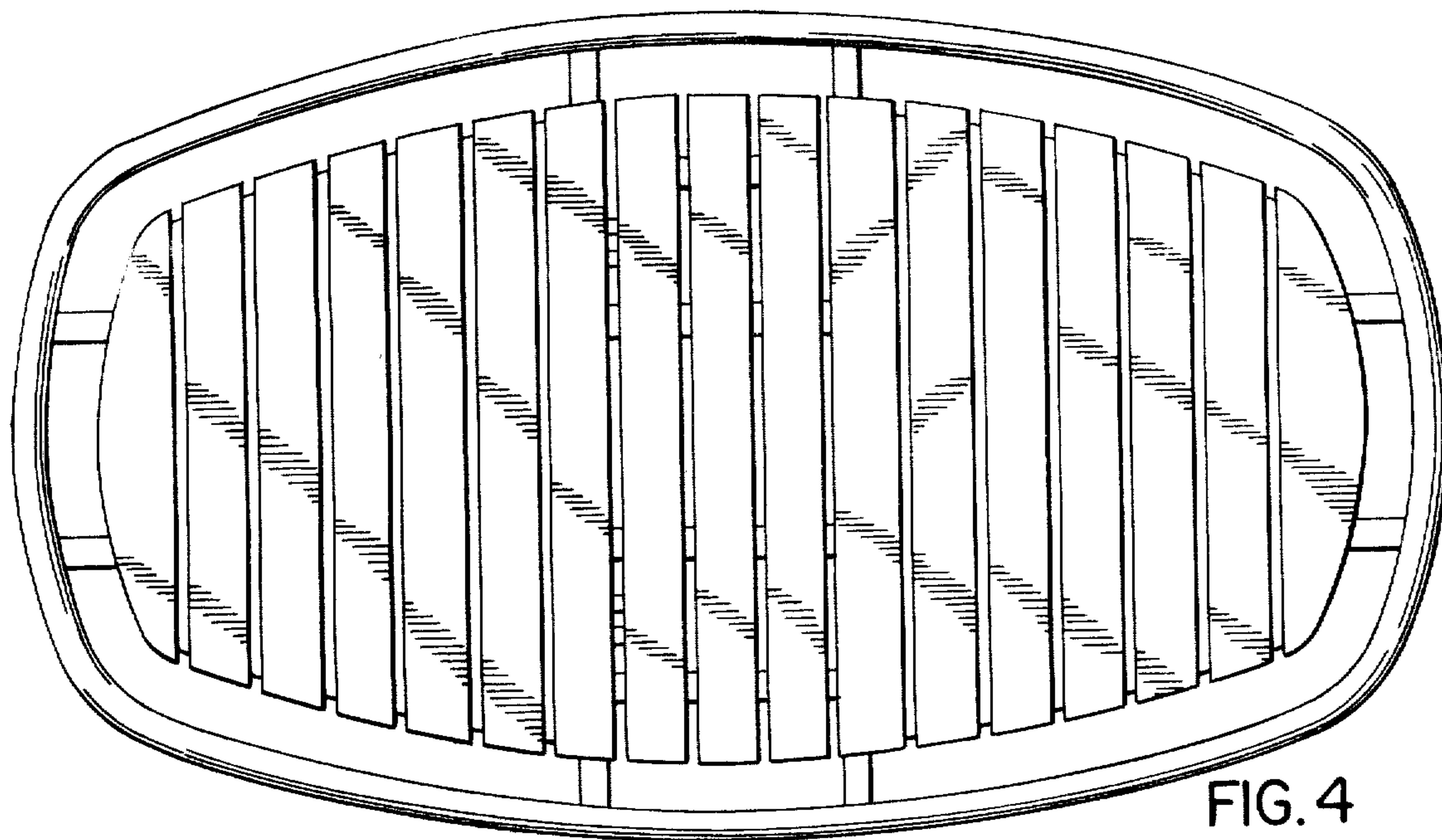

FIG. 4

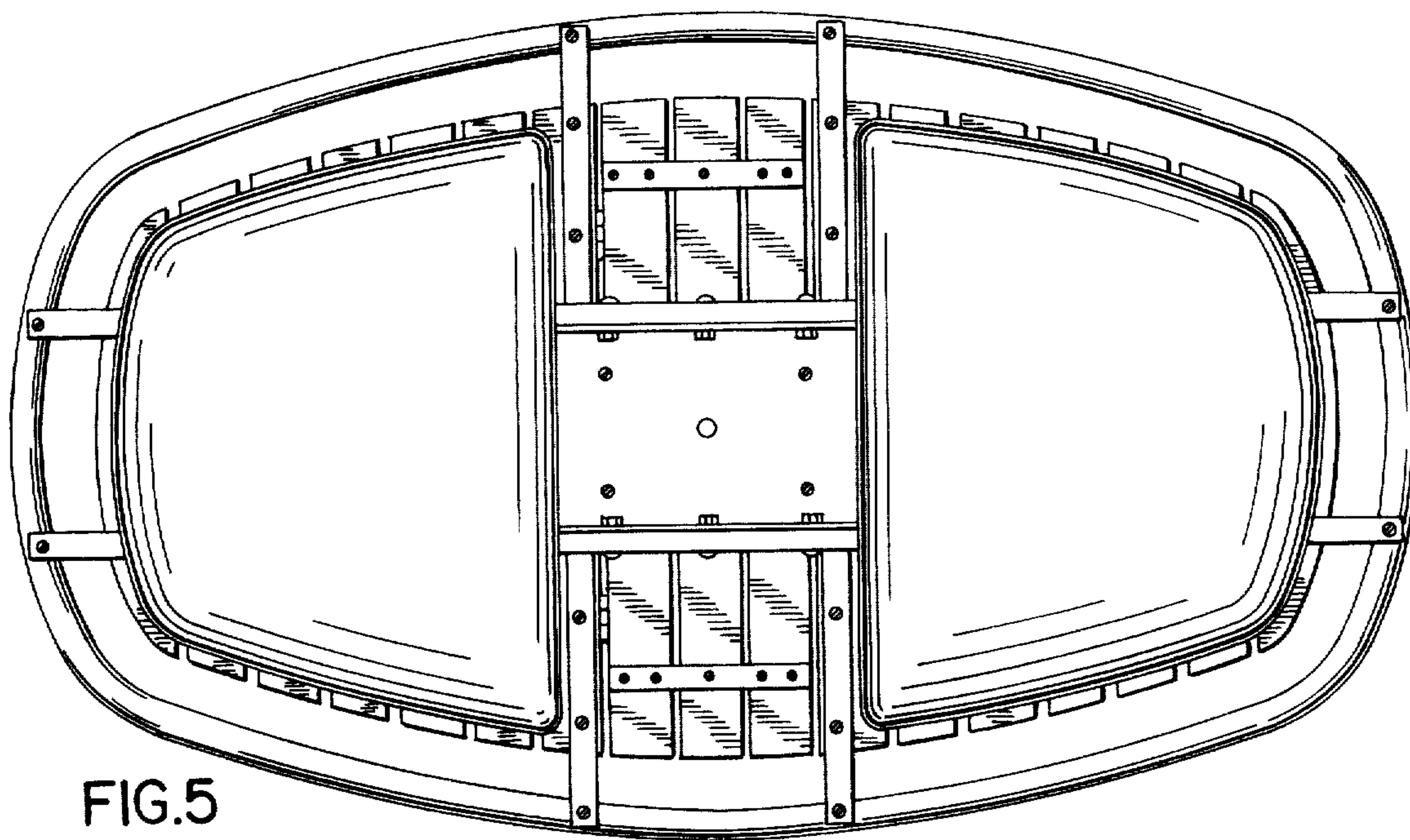

FIG. 5

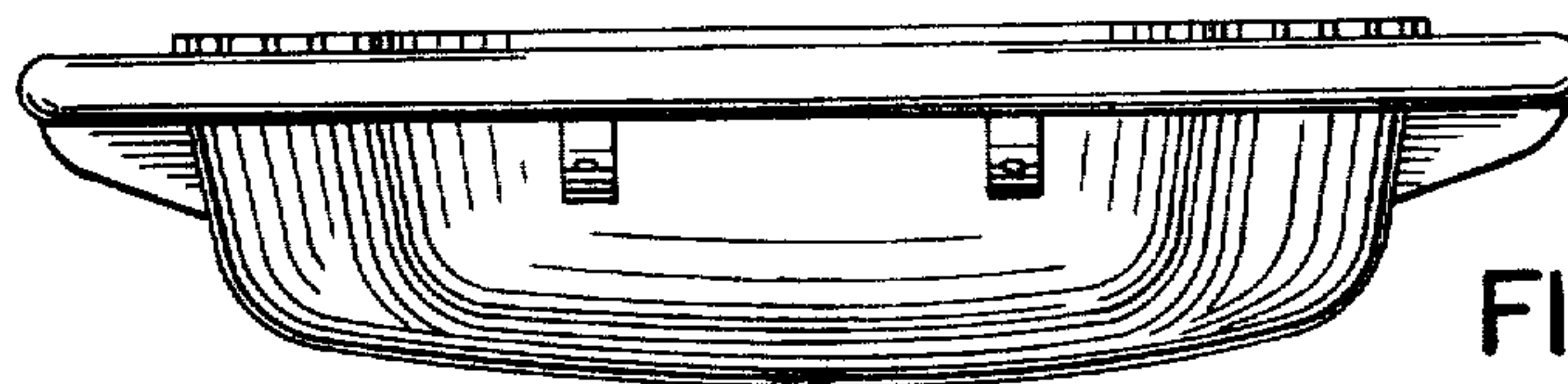

FIG. 6