

[54] WINDOW GREENHOUSE

[75] Inventors: Gordon A. Elleby, Jr., Excelsior; Phillip W. Westbrook, Mound, both of Minn.

[73] Assignee: The Wesby Corporation, Excelsior, Minn.

[**] Term: 14 Years

[21] Appl. No.: 211,526

[22] Filed: Dec. 1, 1980

[51] Int. Cl. D11-02; D25-02

[52] U.S. Cl. D11/145; D25/35; D25/52

[58] Field of Search D11/145; D25/35, 52; 47/40; 52/36, 73; 312/102

[56] References Cited

U.S. PATENT DOCUMENTS

D. 202,058	8/1965	D'Amato	D11/145
D. 237,729	11/1975	Coppa	D11/145
1,214,057	1/1917	Moore	47/40
3,148,479	9/1964	D'Amato	47/40
4,038,791	8/1977	Atkinson	D11/145

Primary Examiner—B. J. Bullock

Attorney, Agent, or Firm—James R. Haller

[57] CLAIM

The ornamental design for a window greenhouse, as shown and described.

DESCRIPTION

FIG. 1 is a perspective view of a window greenhouse showing our new design;
 FIG. 2 is a bottom view thereof;
 FIG. 3 is a side view taken from the right of FIG. 1, the side opposite being a mirror image thereof;
 FIG. 4 is a front view thereof;
 FIG. 5 is a top view thereof;
 FIG. 6 is a rear view thereof; and
 FIG. 7 is a perspective view of a second embodiment of the design of FIG. 1;
 FIG. 8 is a side elevational view taken from the right of FIG. 7, the side opposite being a mirror image thereof;
 FIG. 9 is a bottom view of FIG. 7;
 FIG. 10 is a front view of FIG. 7;
 FIG. 11 is a top view of FIG. 7;
 FIG. 12 is a rear view of FIG. 7.
 The cross line pattern which is partially shown in FIGS. 1, 3, 7 and 8 is understood to repeat uniformly throughout the circumscribed surface and to represent conventional screening.

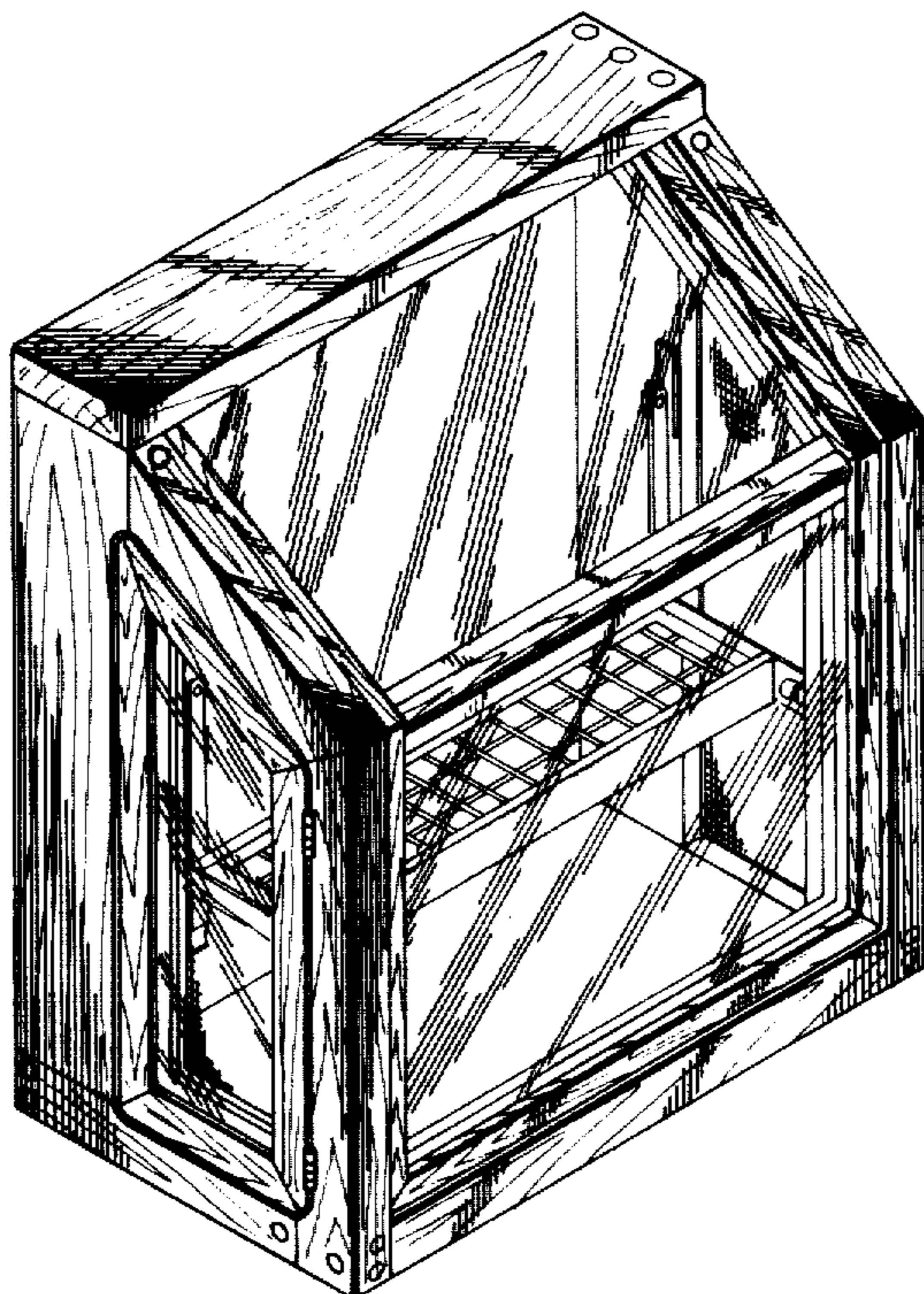

FIG. 1

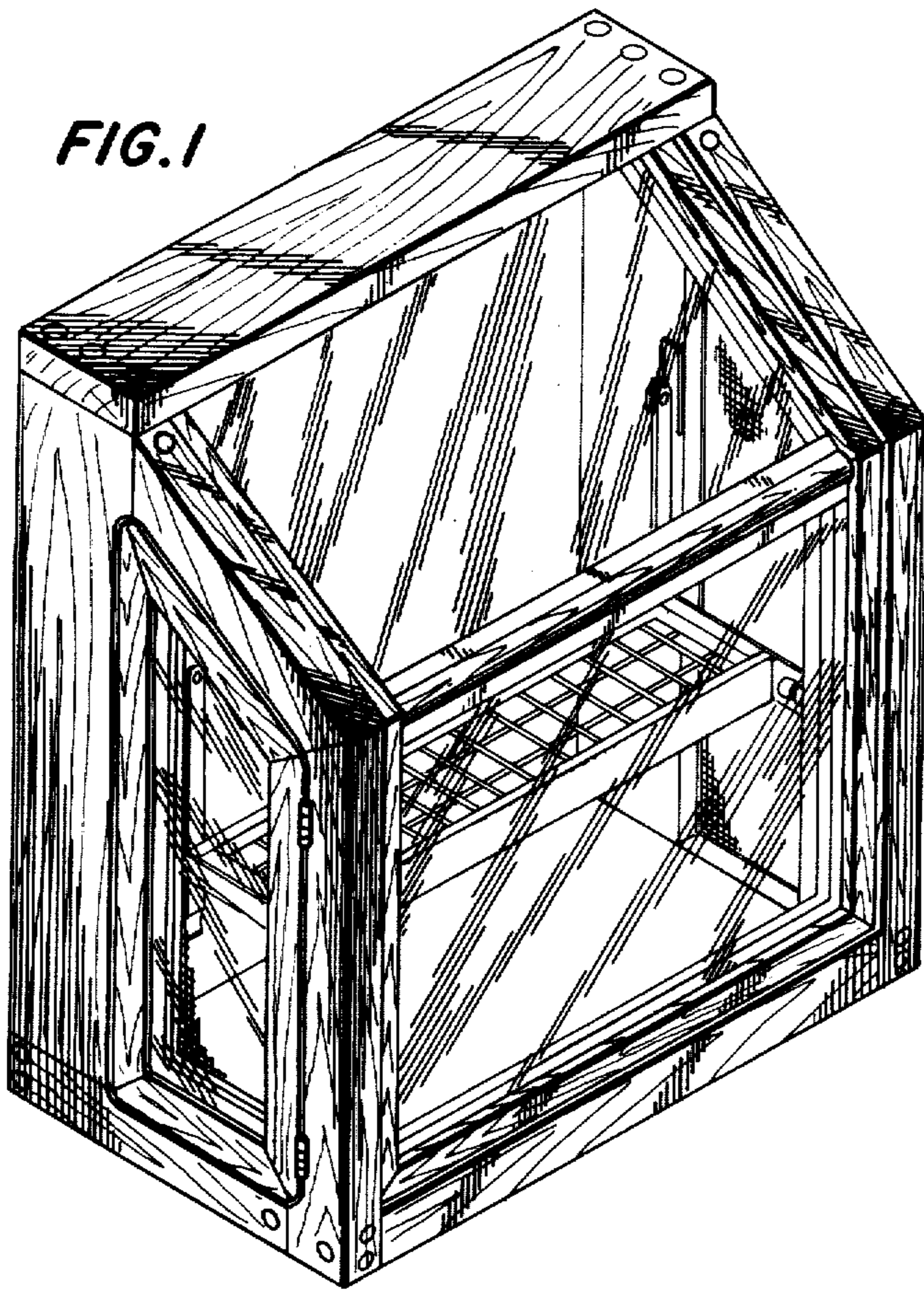

FIG. 3

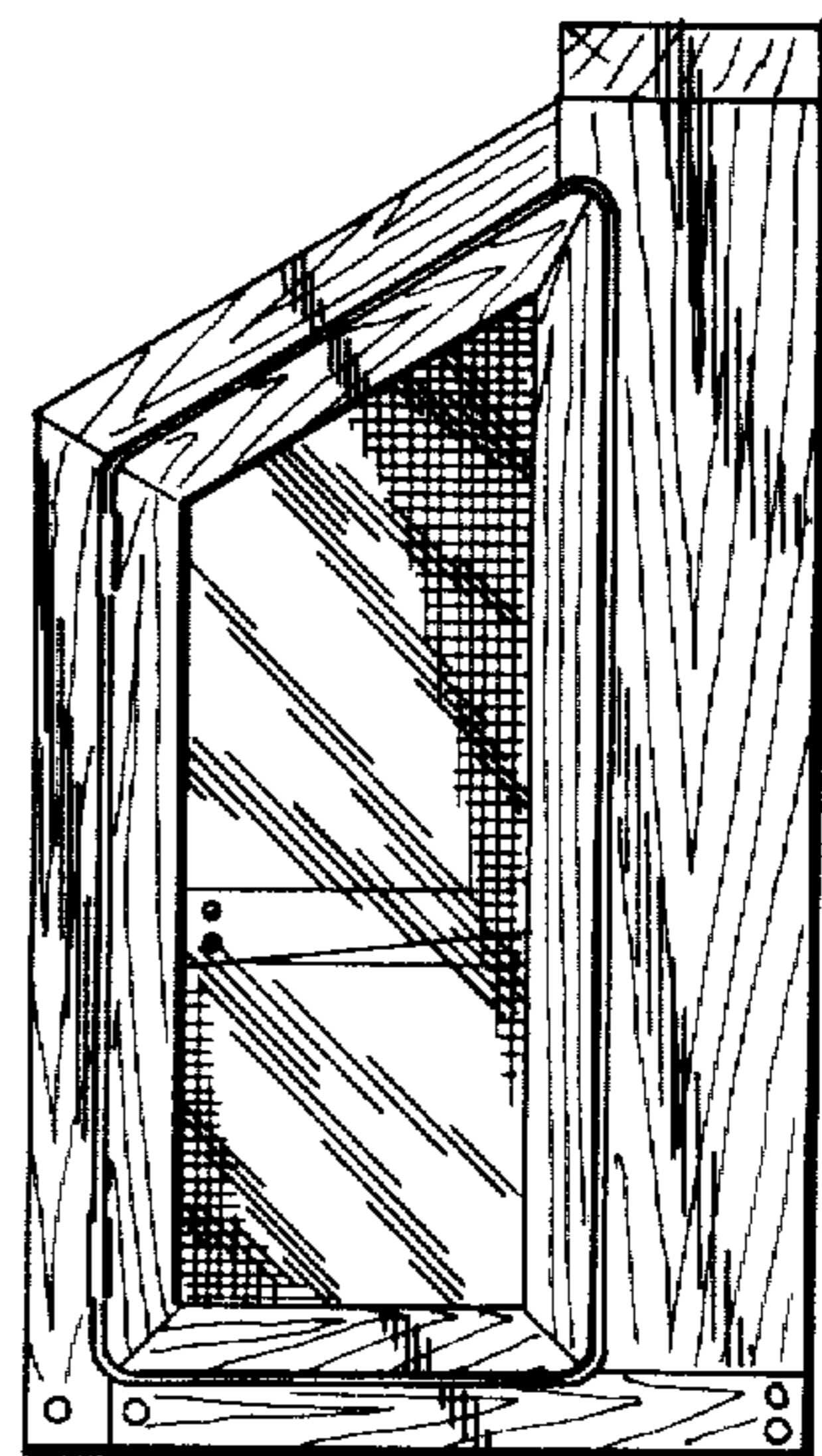
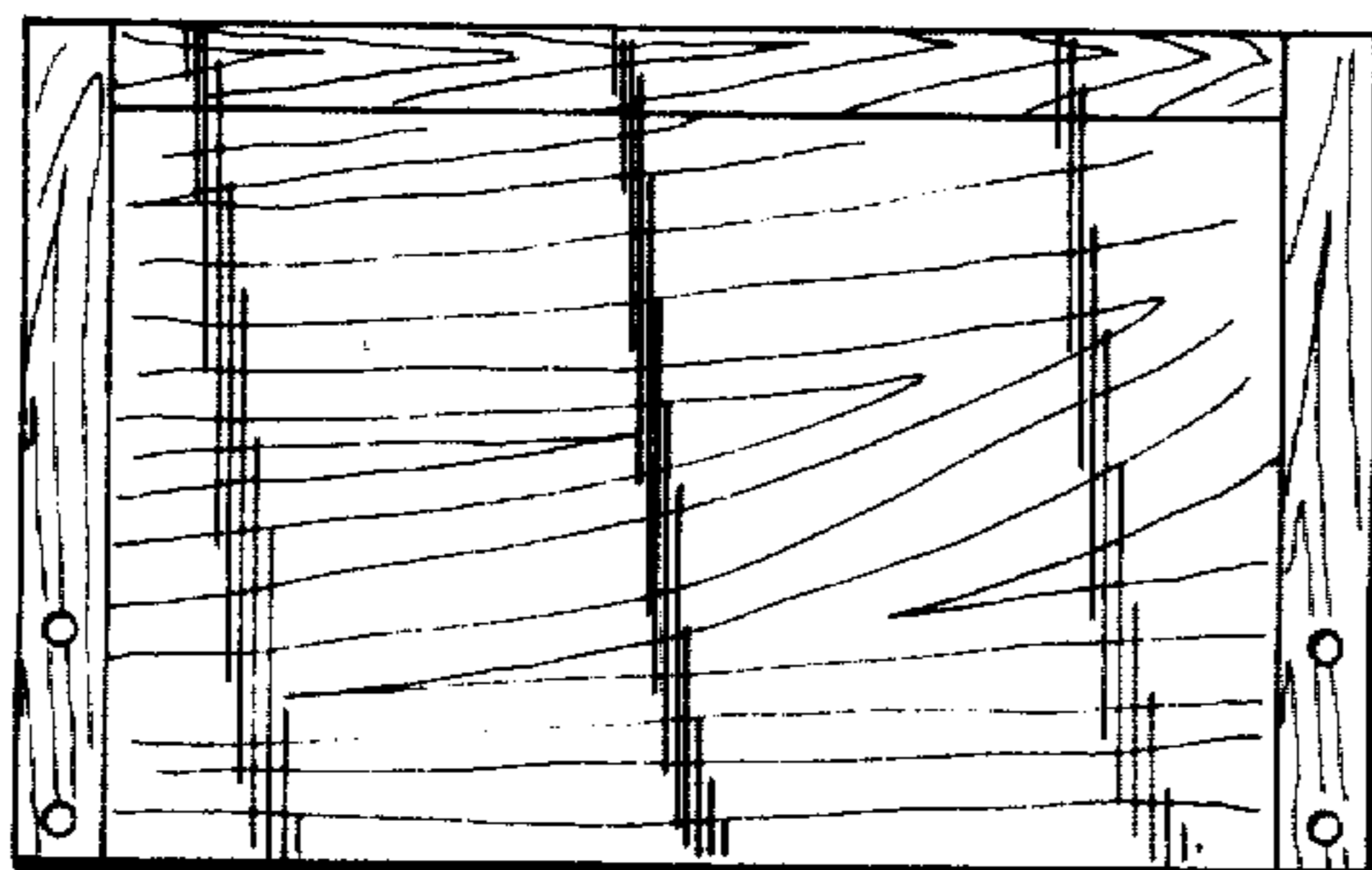

FIG. 2



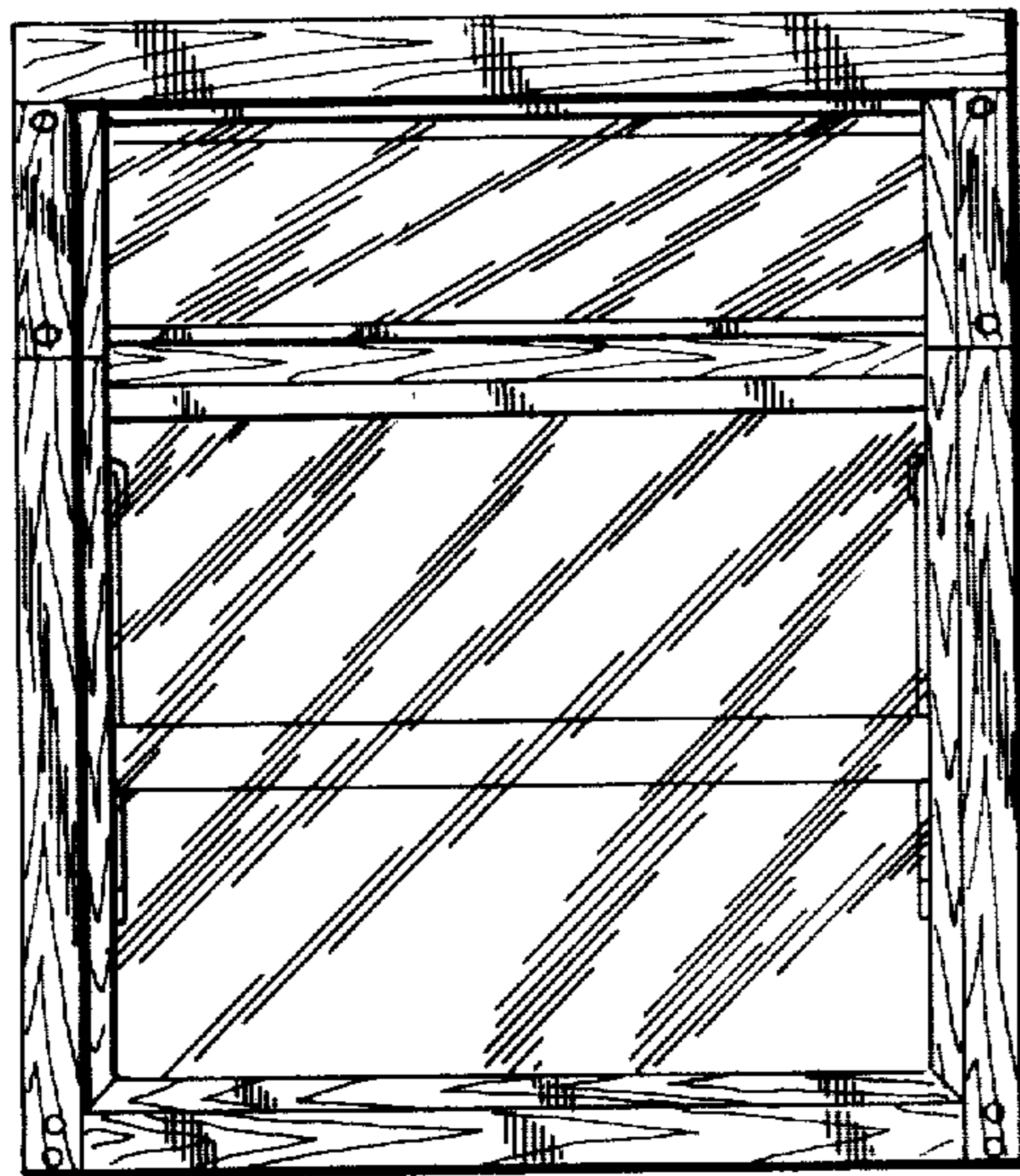

FIG. 4

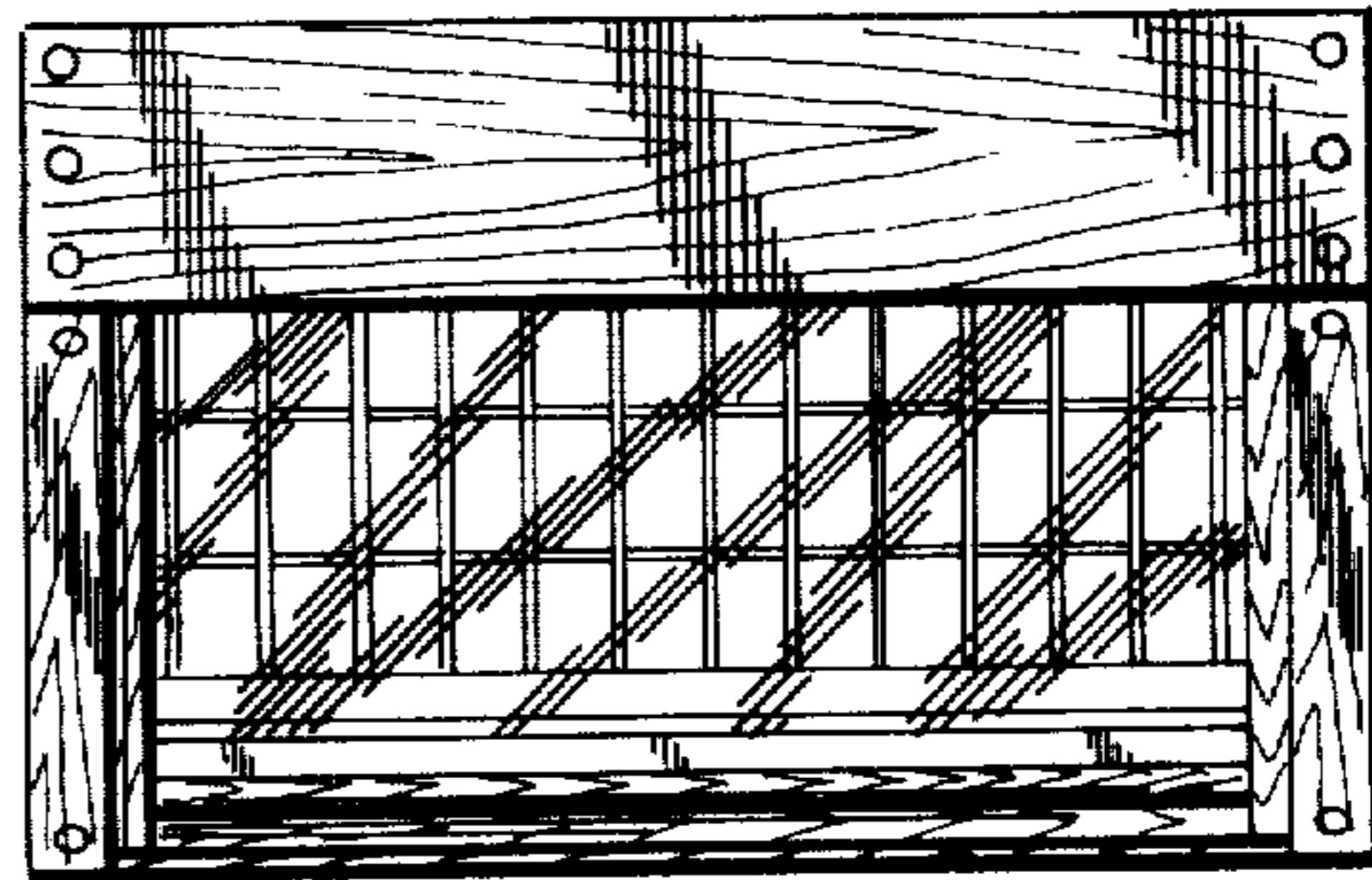

FIG. 5

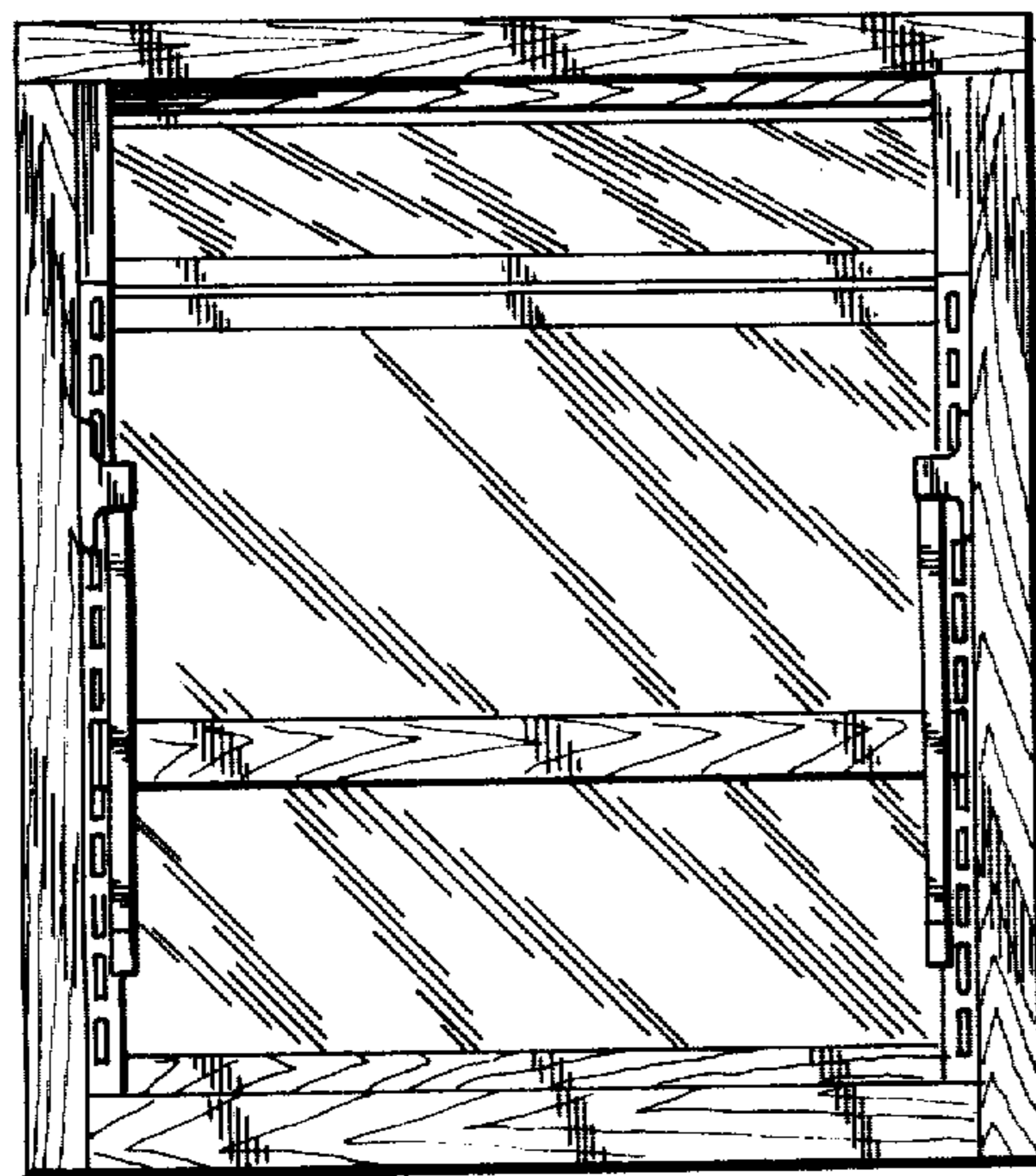

FIG. 6

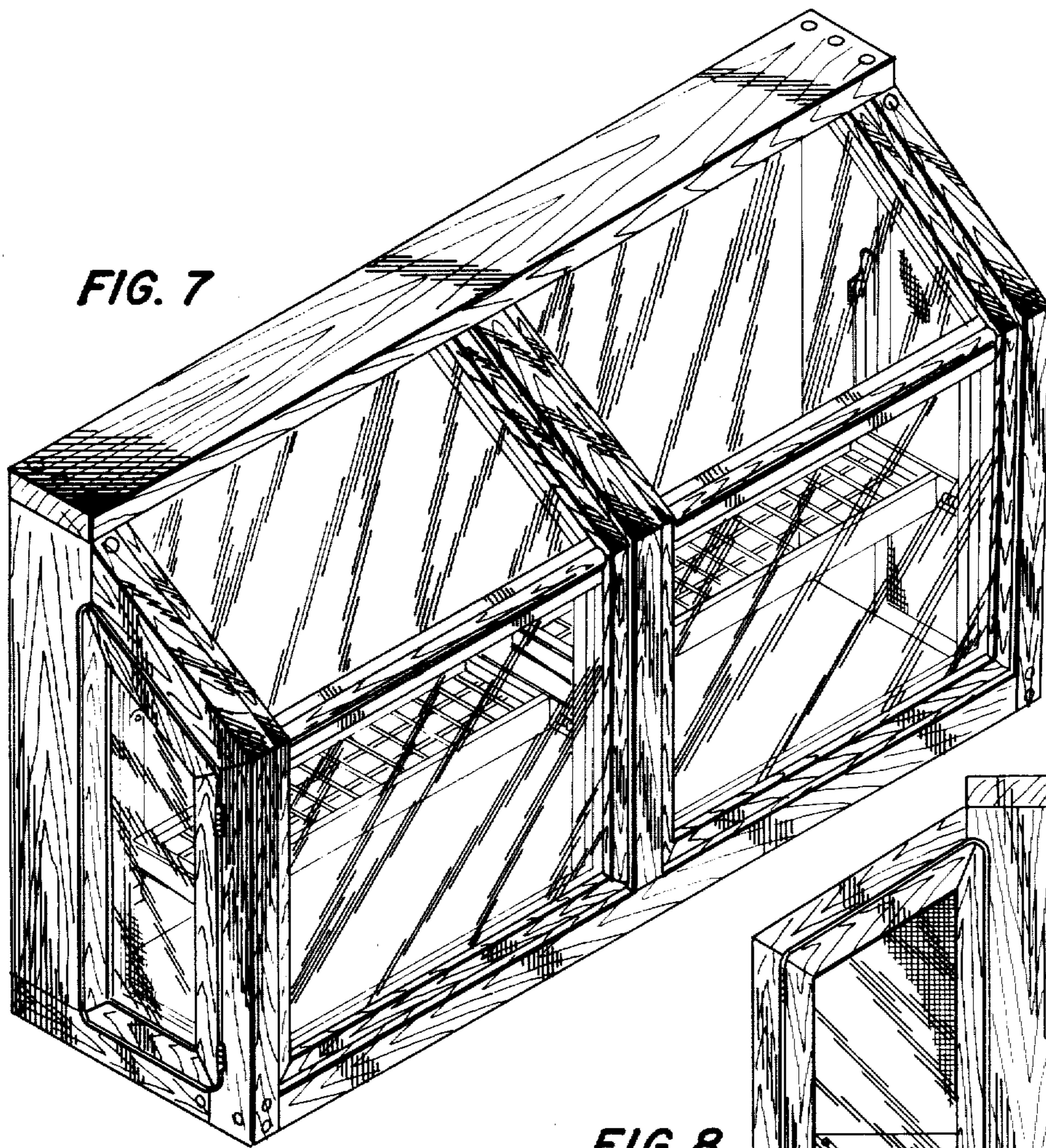

FIG. 7

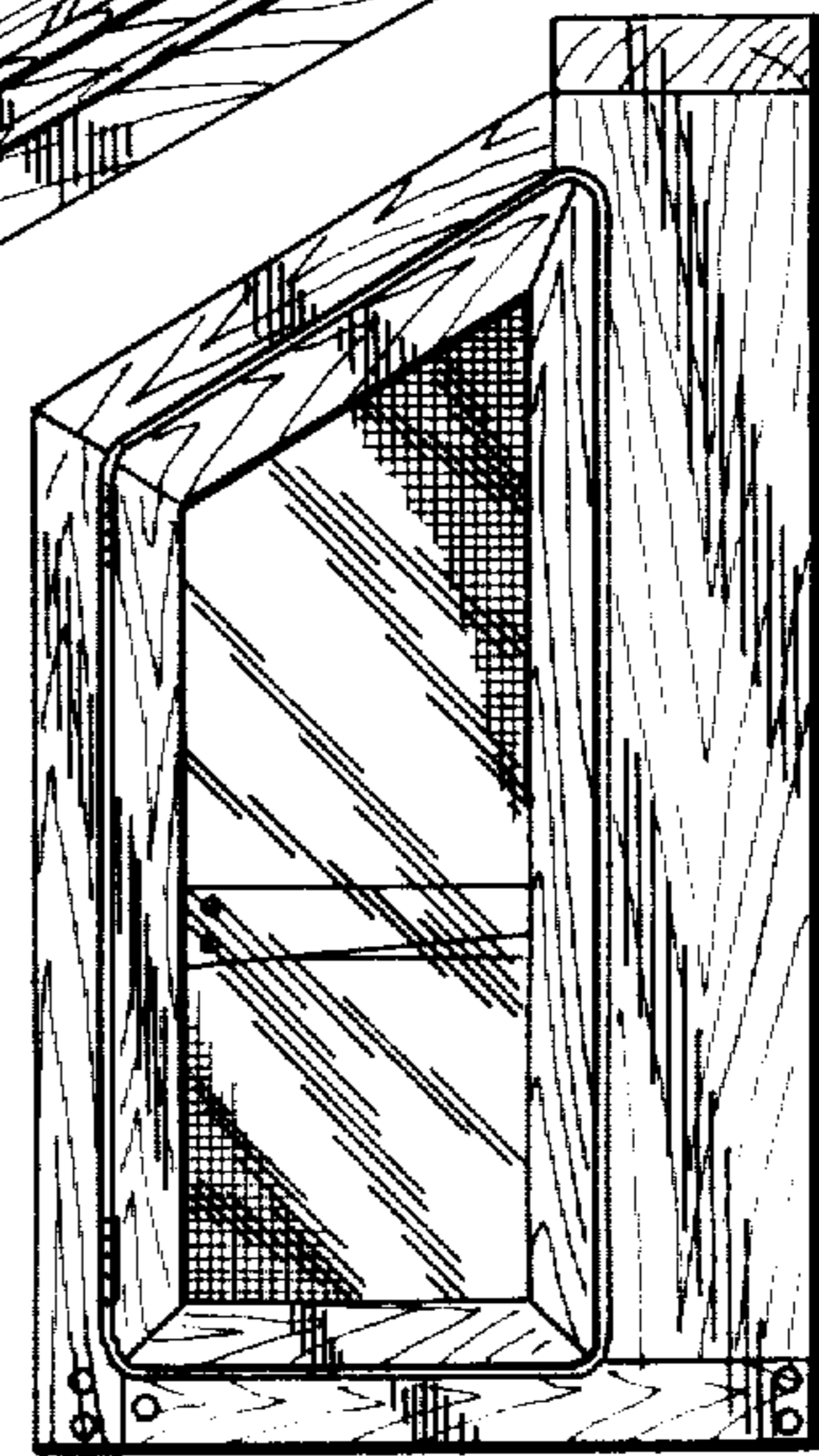

FIG. 8

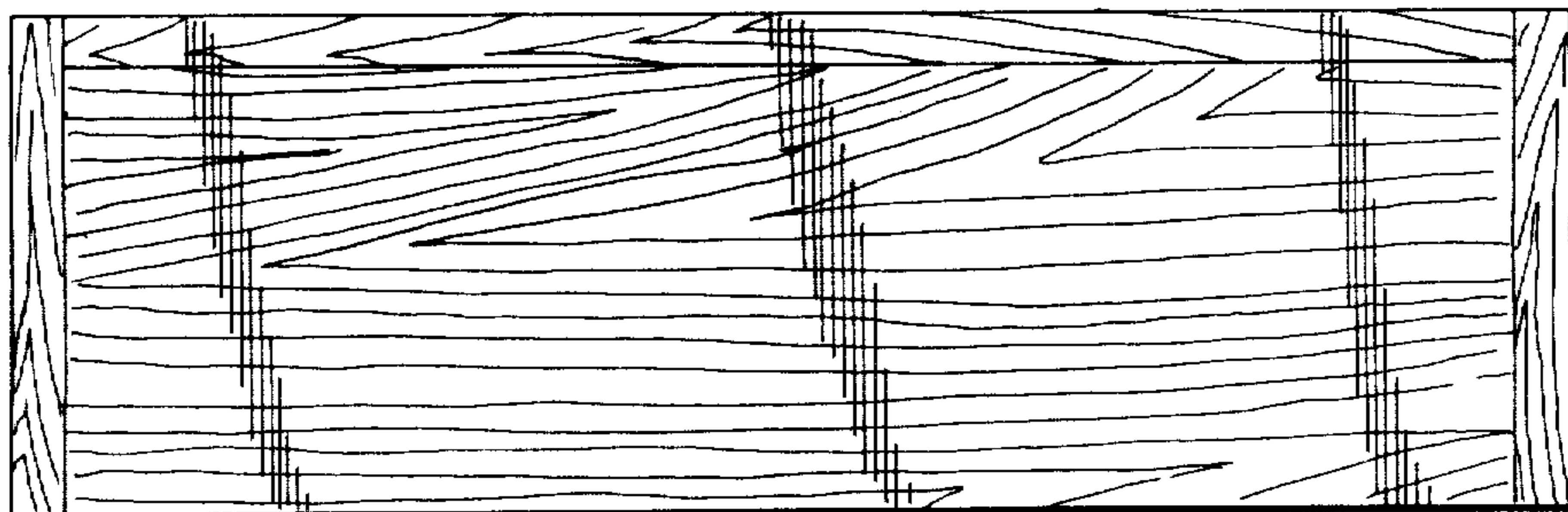

FIG. 9

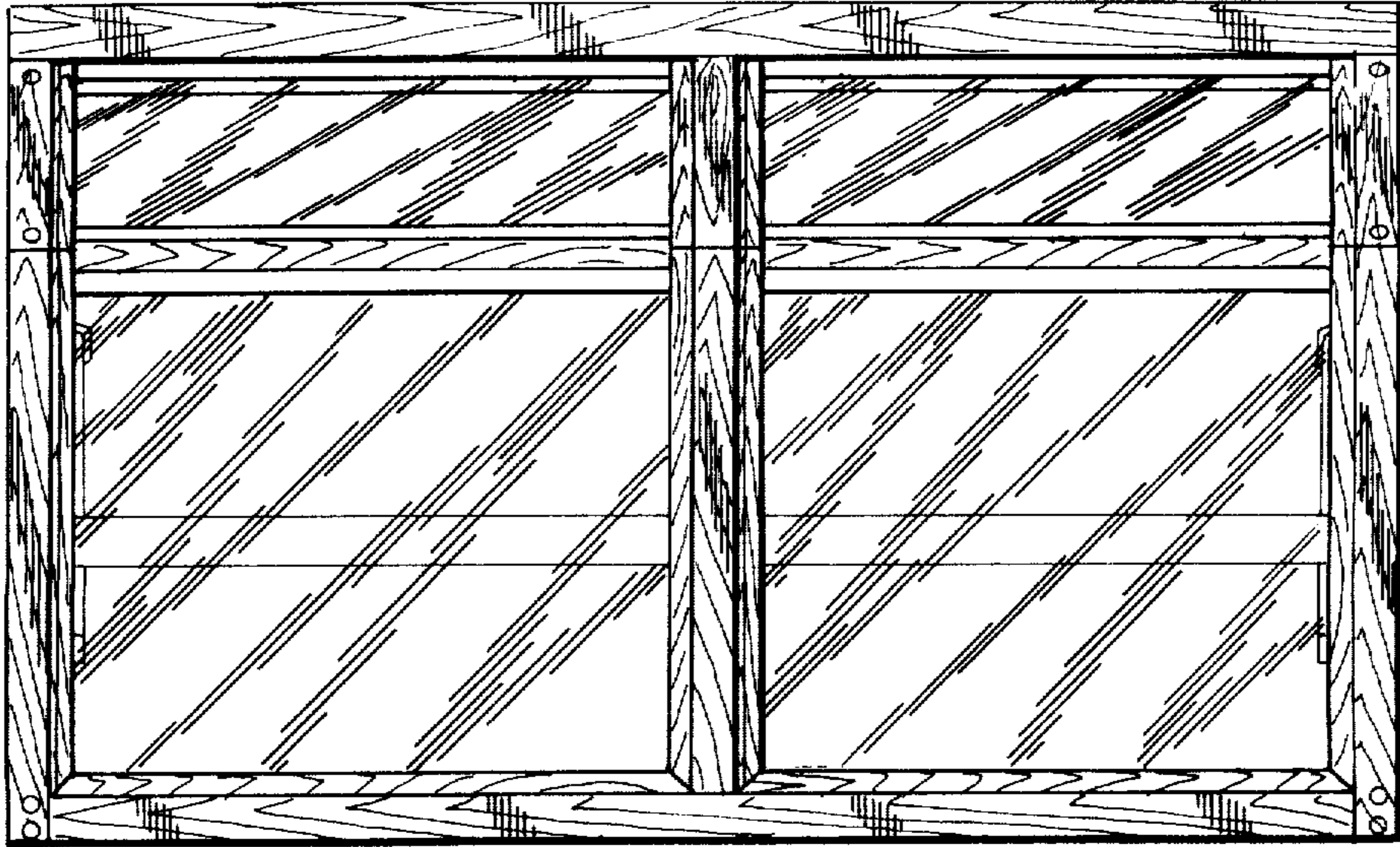

FIG. 10

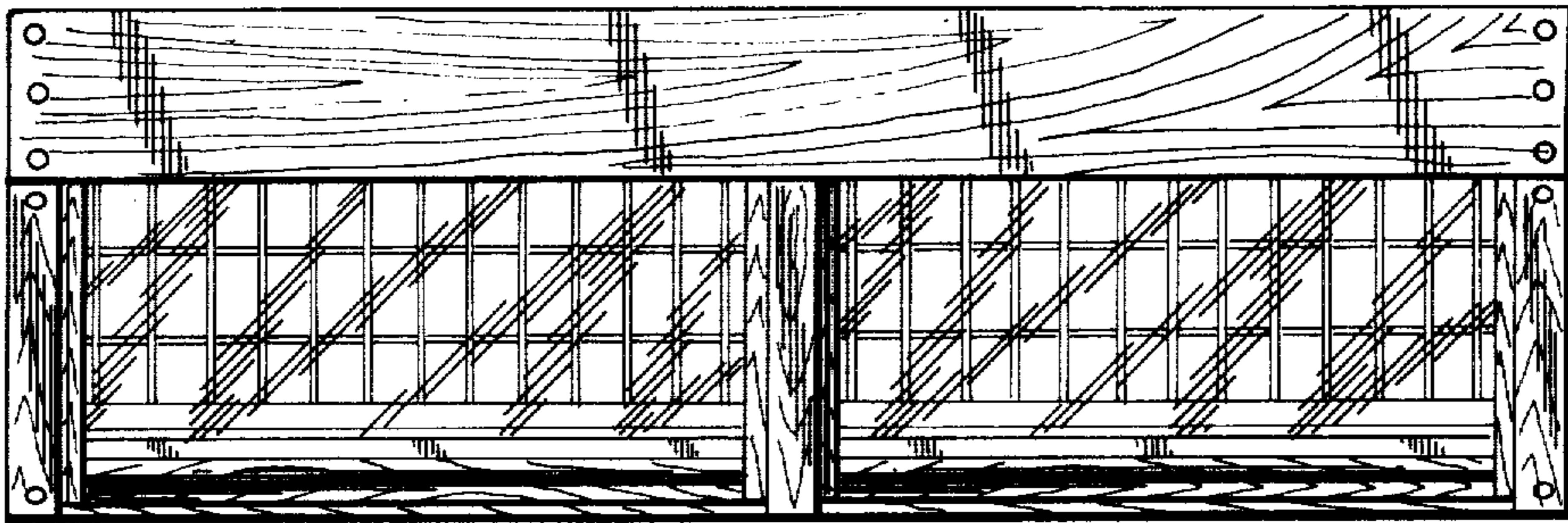

FIG. 11

FIG. 12

