

[54] INSULATED CONTAINER

[75] Inventor: Craig Ruxton, Katy, Tex.
[73] Assignee: Igloo Corporation, Houston, Tex.
[**] Term: 14 Years
[21] Appl. No.: 186,053
[22] Filed: Sep. 10, 1980

[51] Int. Cl. D07-07
[52] U.S. Cl. D7/77
[58] Field of Search D7/76, 77, 78, 131,
D7/132; D3/30.1, 73, 74; D34/43, 40, 44, 45,
46

[56] References Cited

U.S. PATENT DOCUMENTS

D. 195,104	4/1963	Piker	D7/77
D. 197,314	1/1964	Gottsegen	D7/77
D. 239,249	3/1976	Branscum	D7/77
D. 257,934	1/1981	Buss	D7/77
3,791,547	2/1974	Branscum	D7/77 X
3,987,829	10/1976	Leone	D34/43 X

OTHER PUBLICATIONS

Best Products 1980 Buyer's Book, p. 399, Item P, Ther-

mos® Sun Packer, lid flips over to accommodate cups, cans, etc., bottom r. cooler.
Product Brochure of Coleman, (1982), p. 8, "Oscar" Cooler, 2nd. cooler down-left col., lid over to accommodate cans in diagonally opposite corners.
1981 Coolers Picnic Jugs (Thermos®), 10/1/80, p. 1, top center cooler with 2 can holder lid, No. 7710, "L'il Sunpacker".

Primary Examiner—Winifred E. Herrmann
Attorney, Agent, or Firm—Fulbright & Jaworski

[57] CLAIM

The ornamental design for an insulated container, substantially as shown.

DESCRIPTION

FIG. 1 is a back and left-side pictorial view thereof;
FIG. 2 is a front elevational view thereof;
FIG. 3 is a side view thereof;
FIG. 4 is a bottom view thereof;
FIG. 5 is a top plan view thereof;
FIG. 6 is a front elevational view of the lid only;
FIG. 7 is a bottom plan view of the lid;
FIG. 8 is a side view of the lid;
FIG. 9 is a sectional view taken along lines 9—9 of FIG. 5; and
FIG. 10 is a sectional view taken along lines 10—10 of FIG. 5.

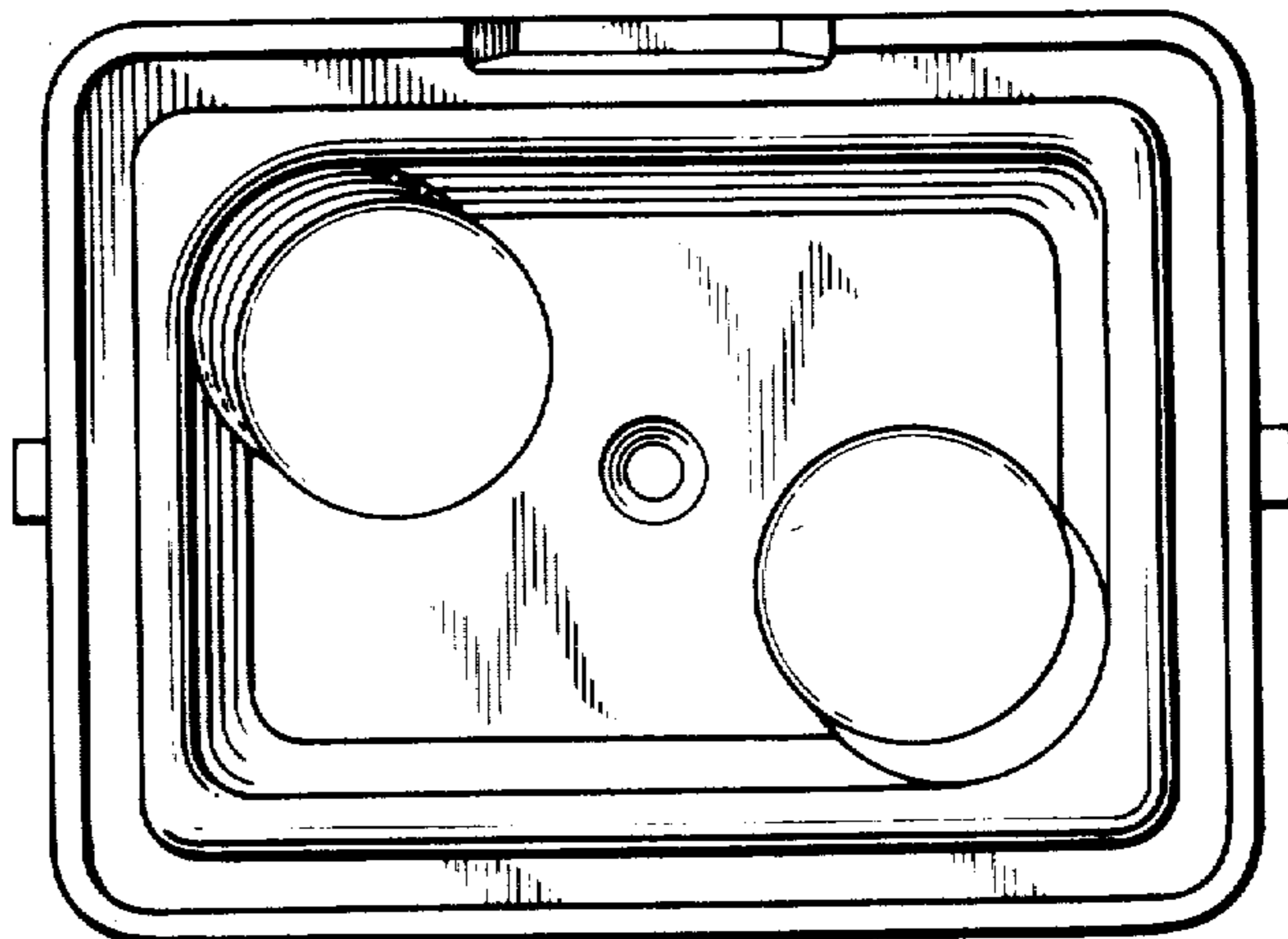
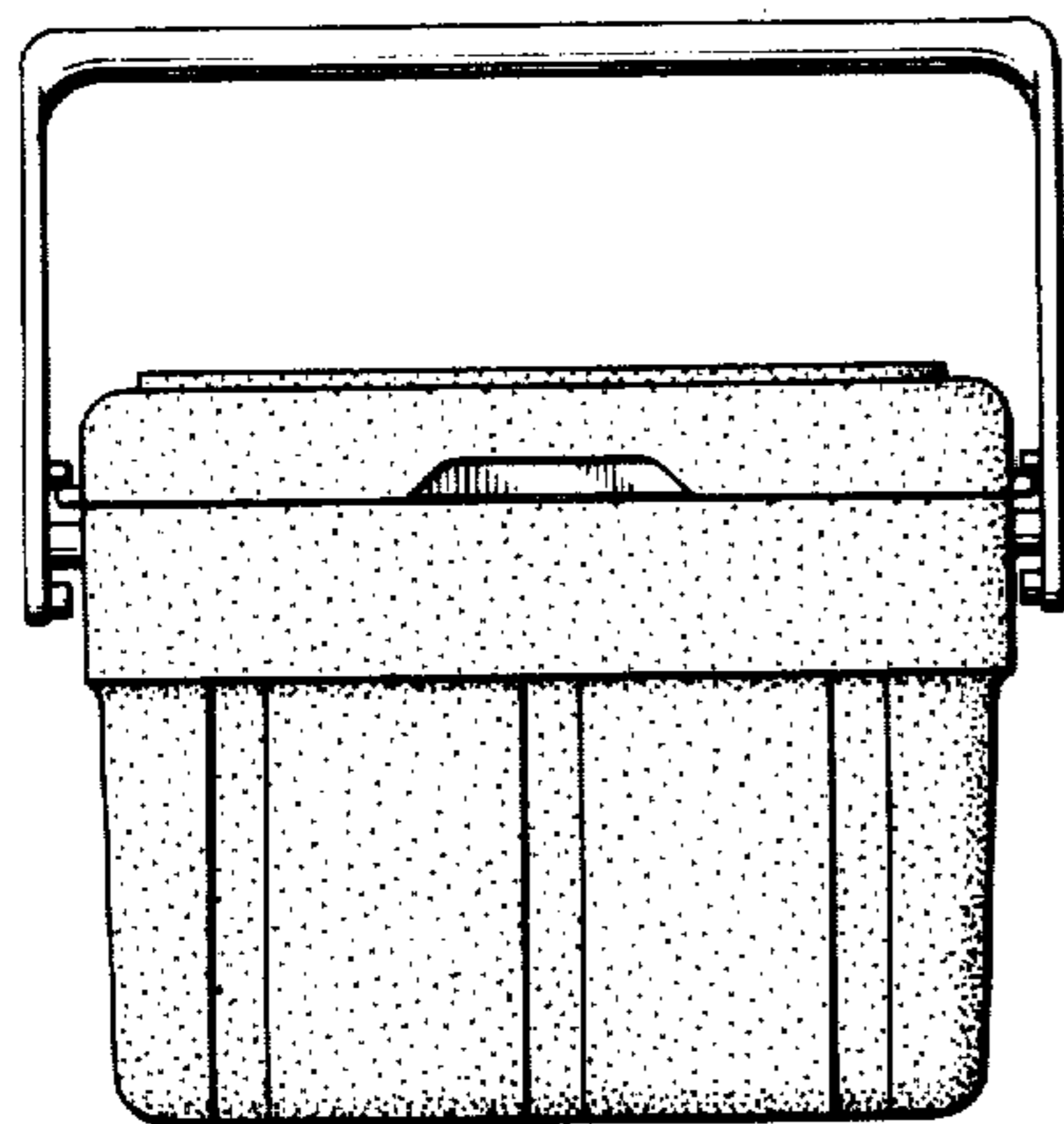
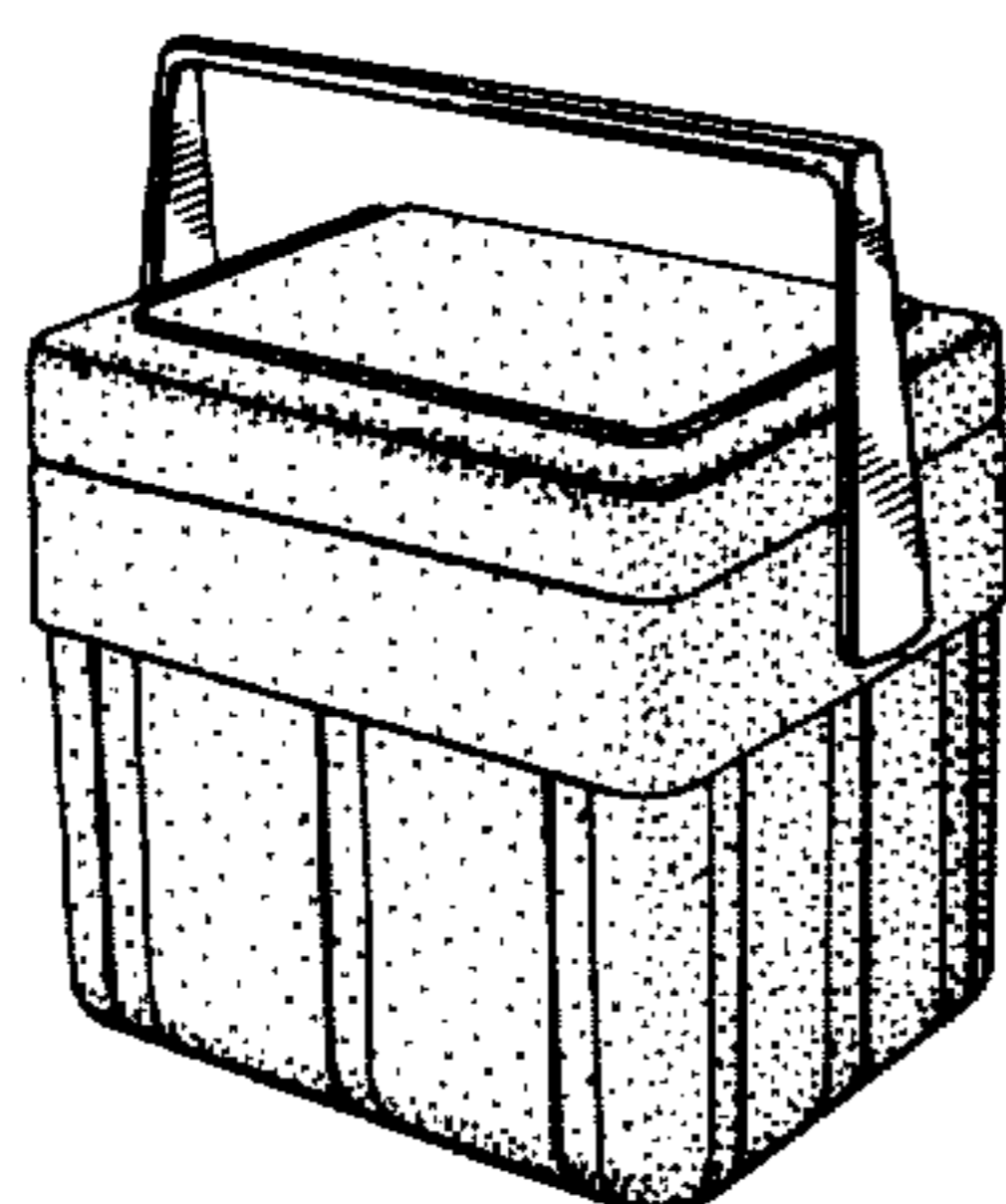

Fig. 1

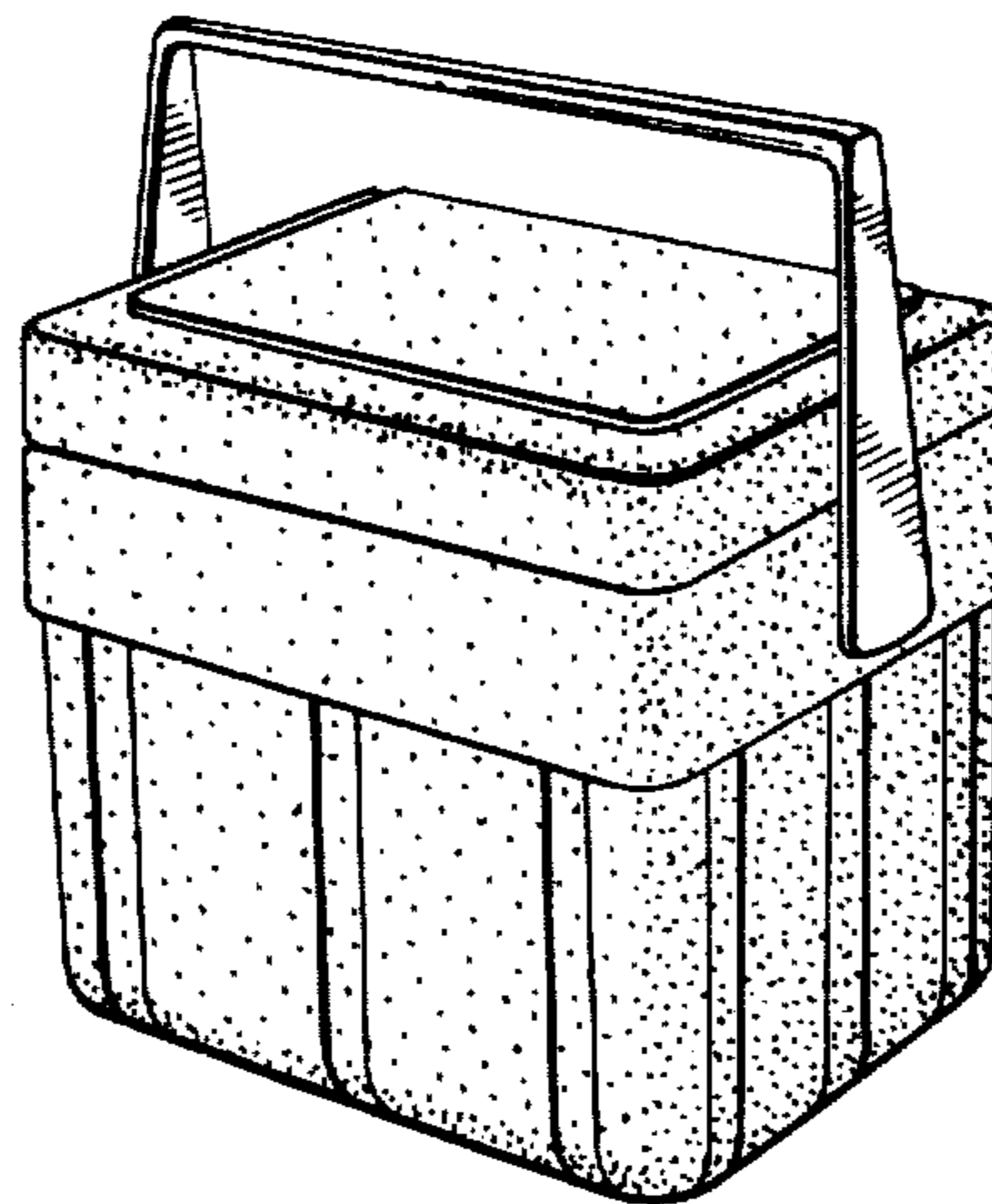

Fig. 2

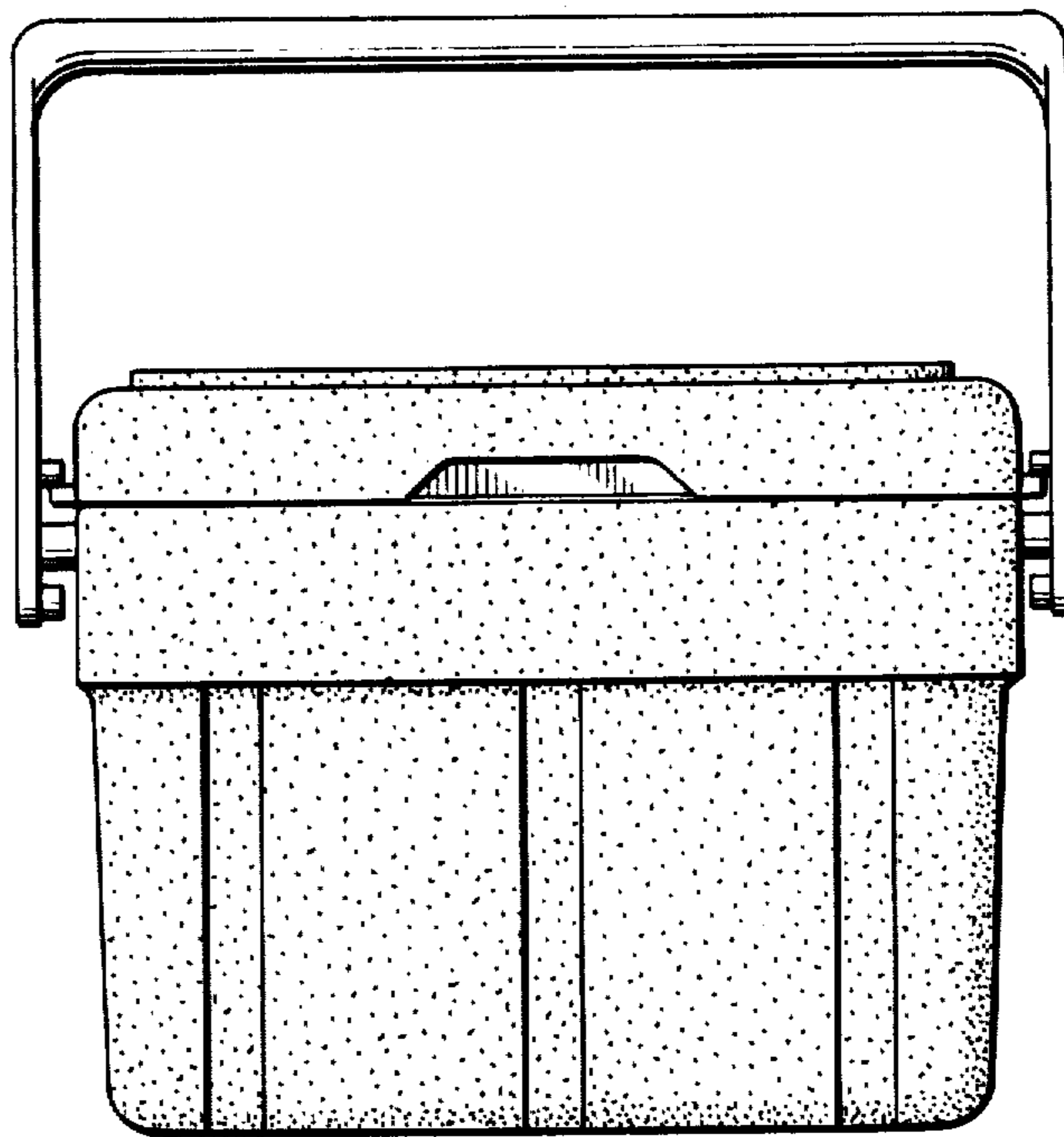

Fig. 3

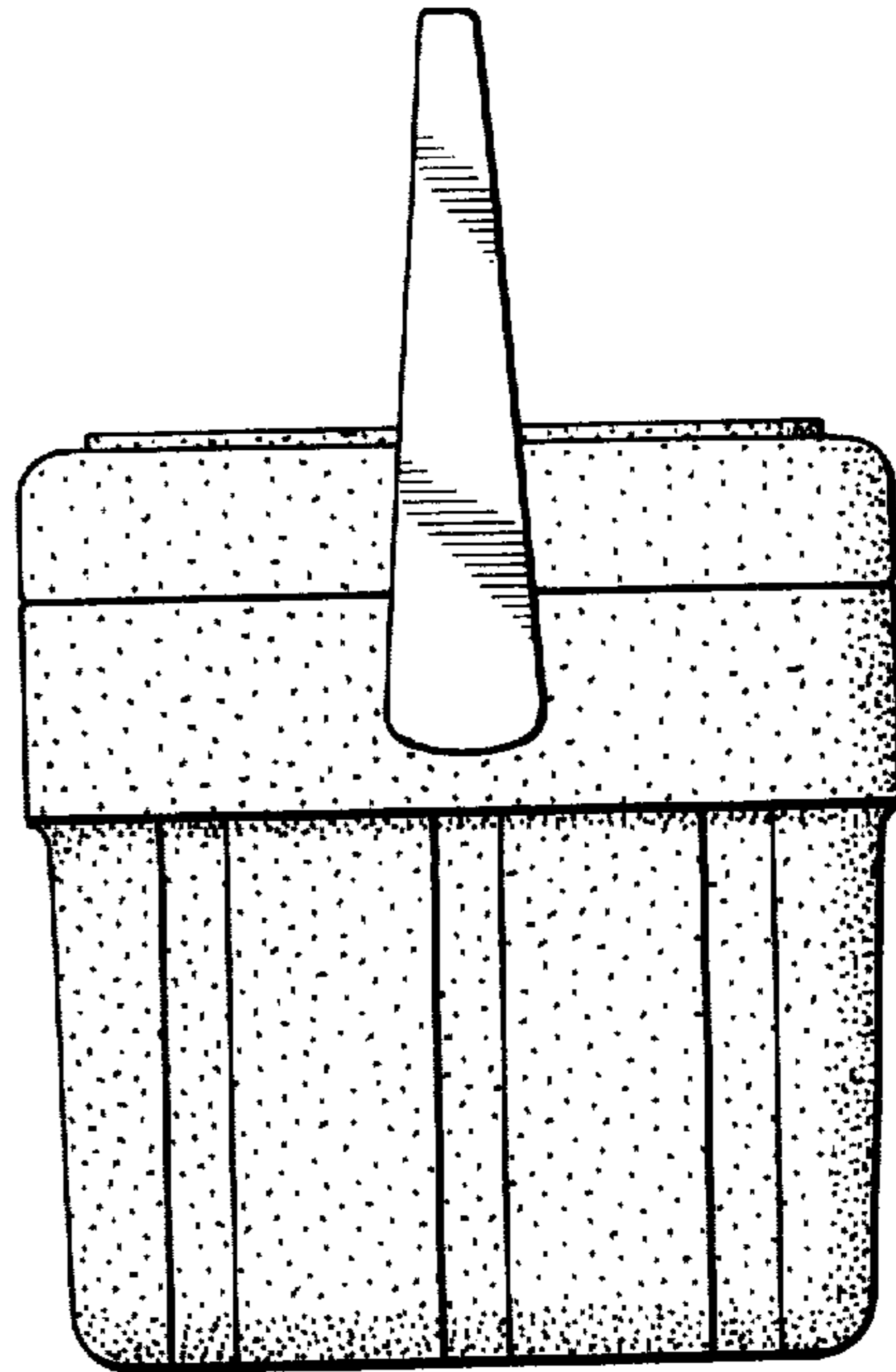

Fig. 4

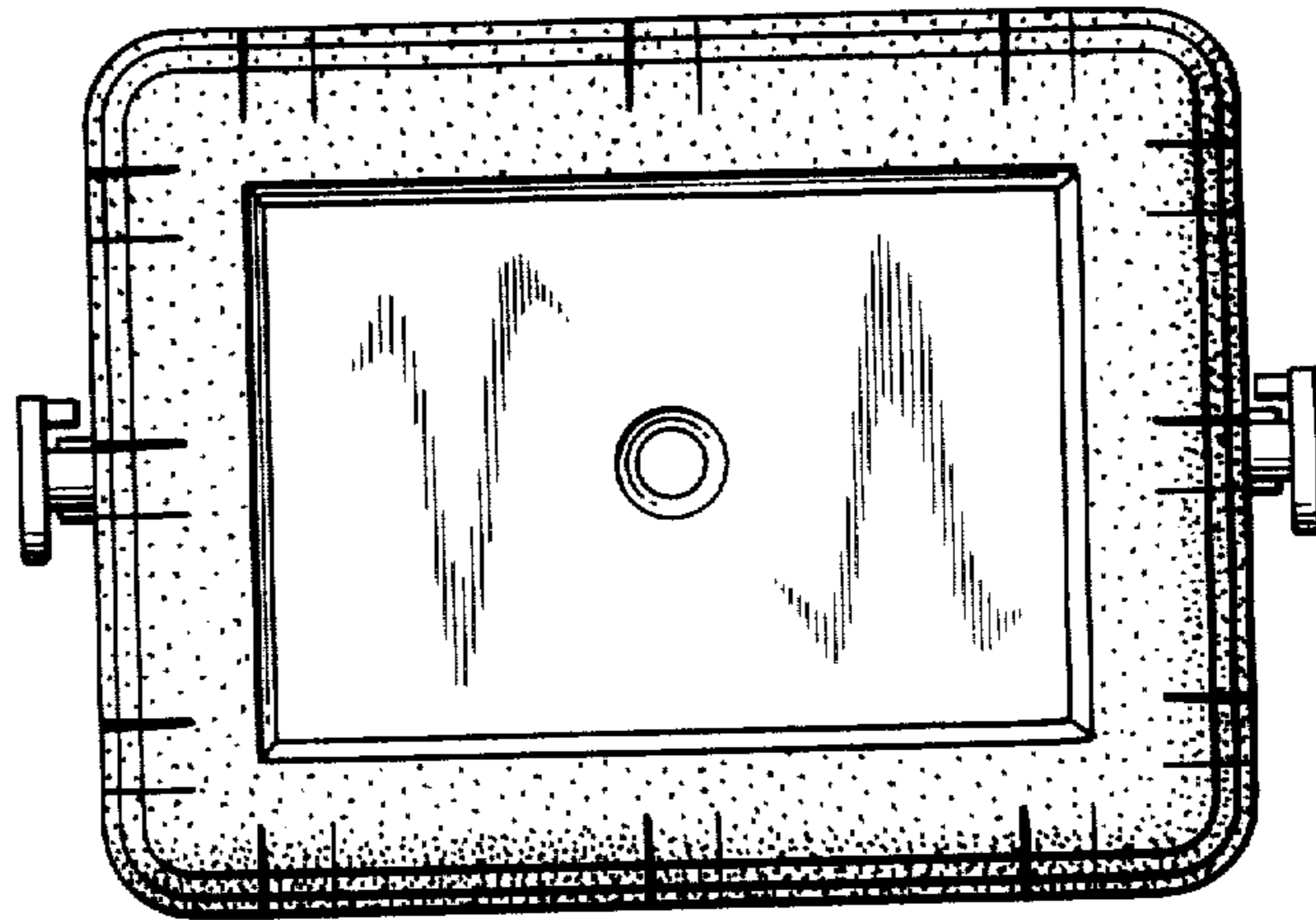

Fig. 5

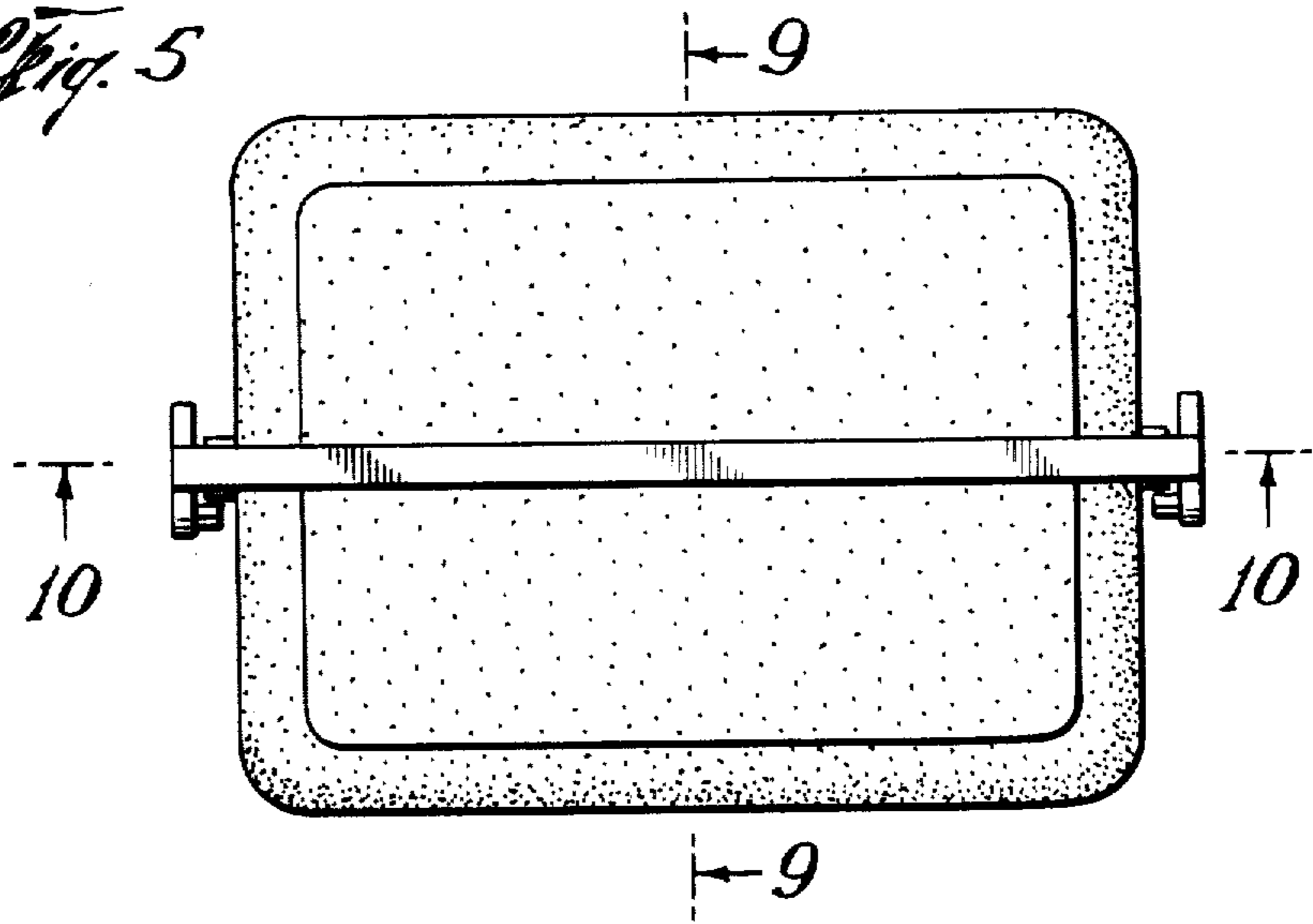

Fig. 6

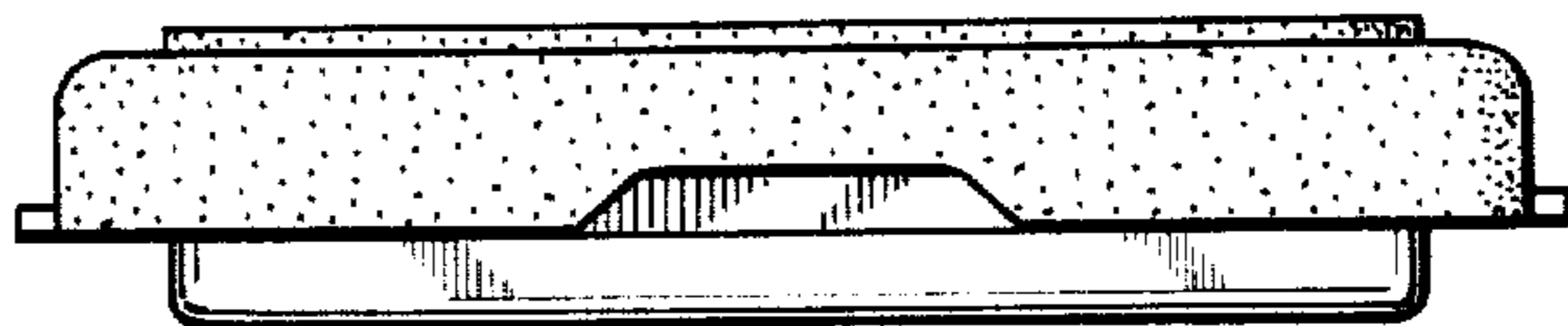

Fig. 7

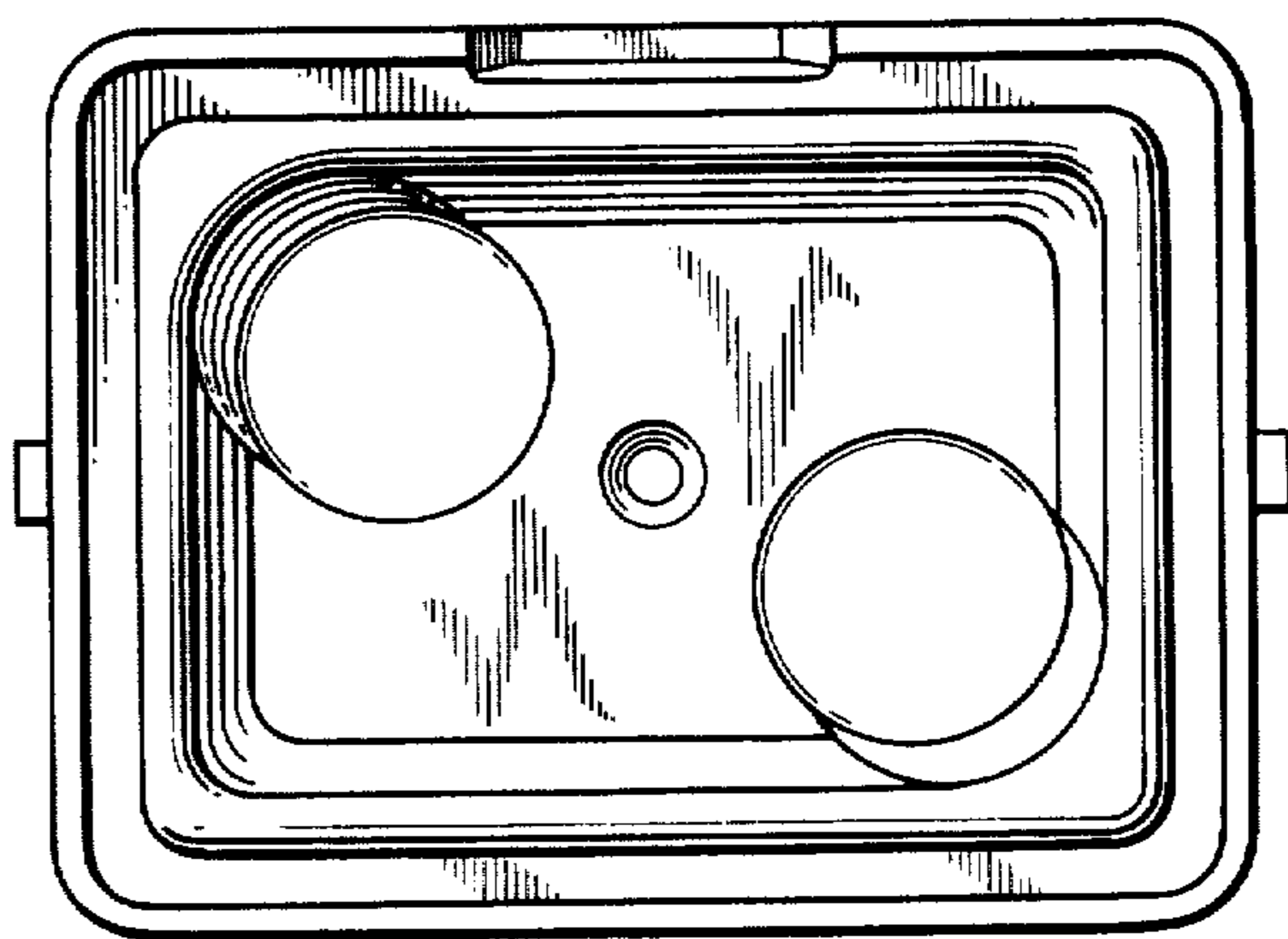

Fig. 8

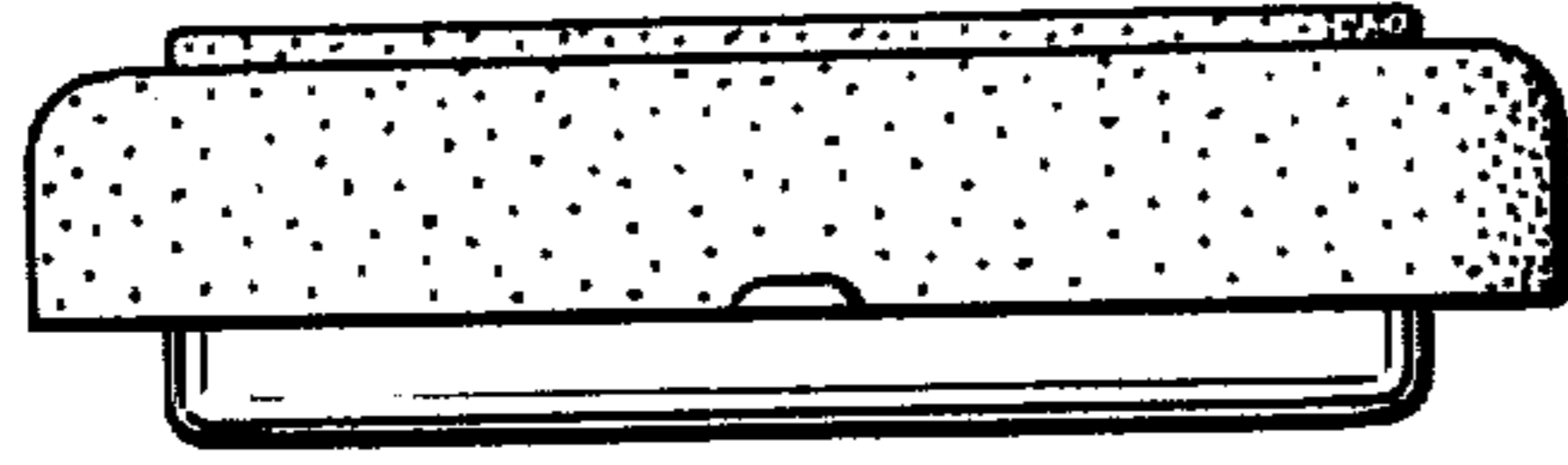

Fig. 9

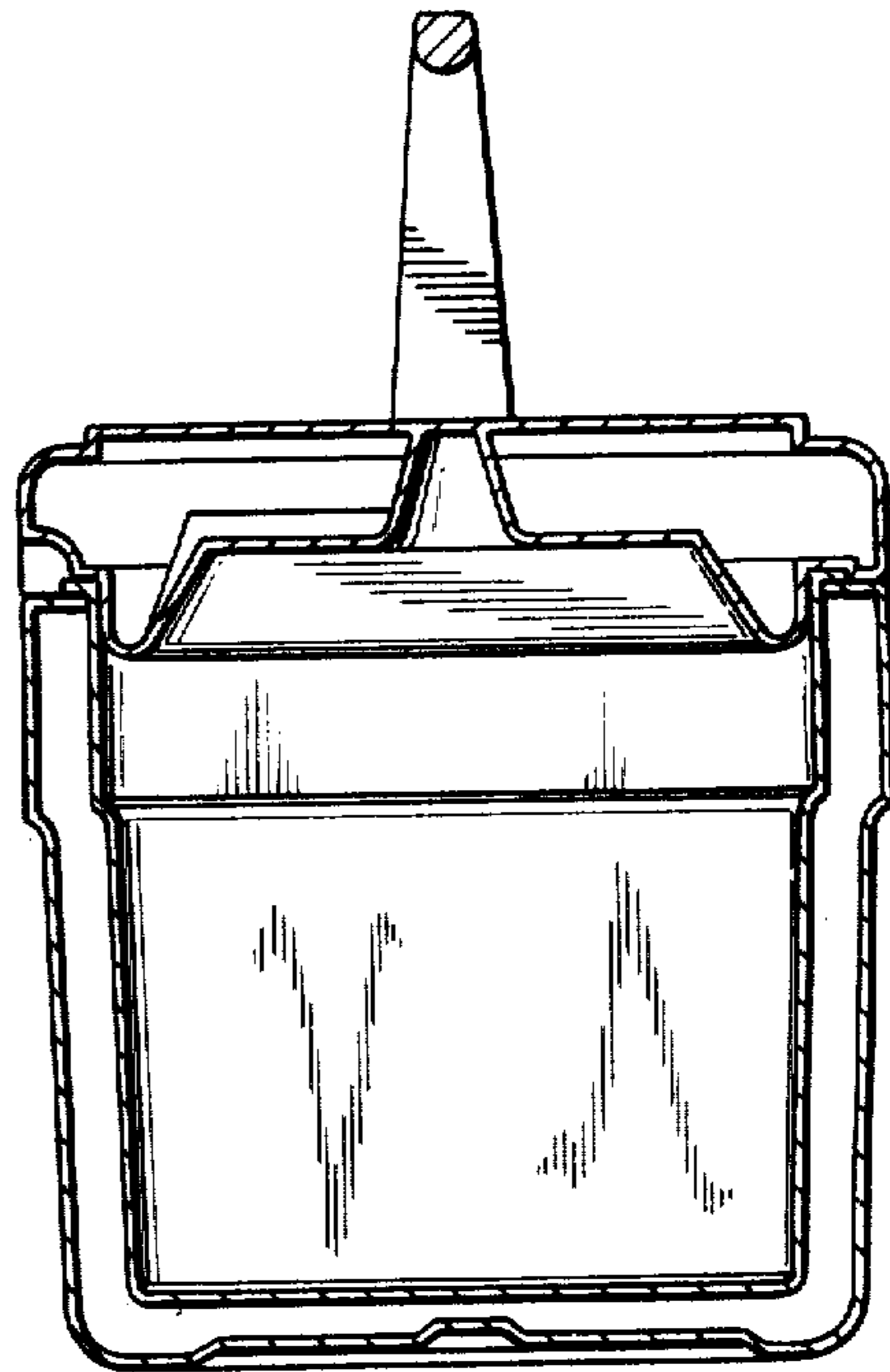

Fig. 10

