

[54] **MEN'S UNDERWEAR**

[76] **Inventor:** Edwin H. Riedell, 57370 29 Palms Hwy., Yucca Valley, Calif. 92284

[**] **Term:** 14 Years

[21] **Appl. No.:** 153,532

[22] **Filed:** May 27, 1980

[51] **Int. Cl.** D2-01
[52] **U.S. Cl.** D2/1
[58] **Field of Search** D2/1, 10, 42; 2/403; 128/158

[56] **References Cited**
U.S. PATENT DOCUMENTS

D. 233,633 11/1974 Burkard D2/10
688,804 12/1901 Wieland 128/158
967,736 8/1910 Delp 128/158

OTHER PUBLICATIONS

Gentlemen's Quarterly, Summer '76, p. 164, Items "A & D".

Primary Examiner—Jane E. Corrigan
Attorney, Agent, or Firm—Cislo, O'Reilly & Thomas

[57] **CLAIM**

The ornamental design for men's underwear, as shown and described.

DESCRIPTION

FIG. 1 is a perspective view of men's underwear showing my new design;
FIG. 2 is a front elevational view;
FIG. 3 is a left side elevational view;
FIG. 4 is a right side elevational view;
FIG. 5 is a top plan view;
FIG. 6 is a bottom plan view;
FIG. 7 is a rear elevational view;
FIG. 8 is a view similar to FIG. 1 of a modified form of men's underwear showing my new design; and
FIG. 9 is a view similar to FIG. 1 of another modified form of men's underwear showing my new design, wherein a symmetrical inner elastic band is included on the pouch.

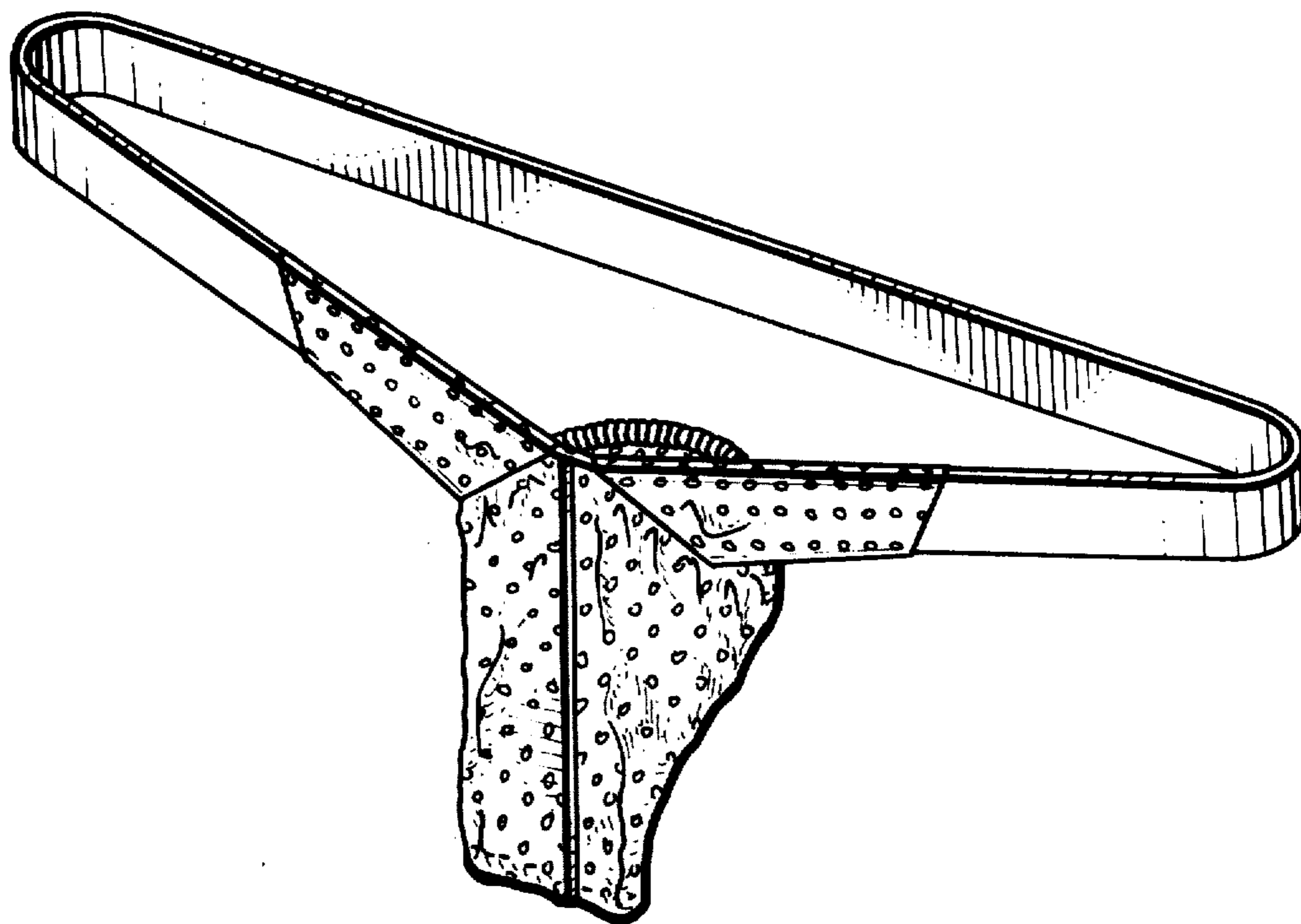

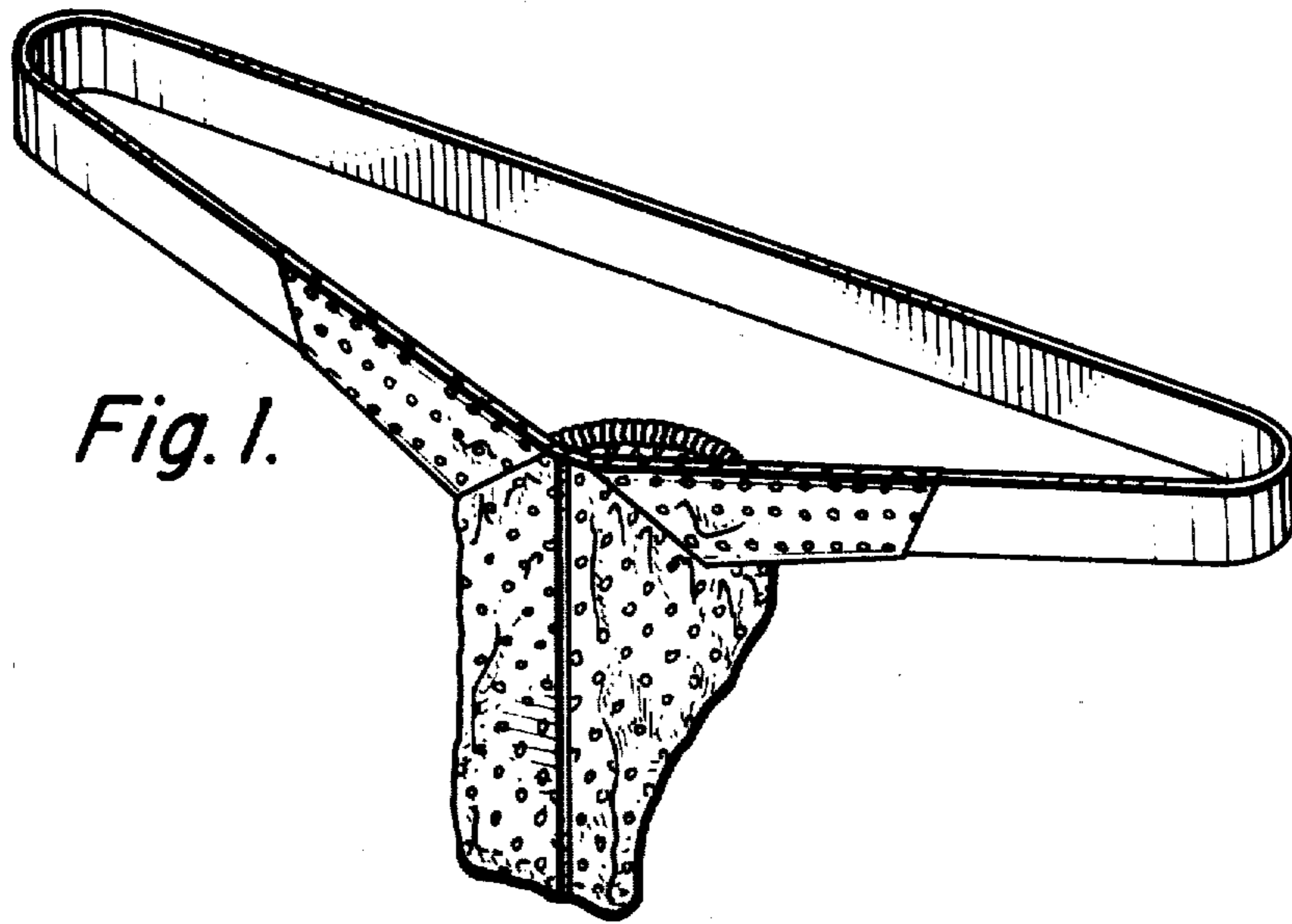

Fig. 1.

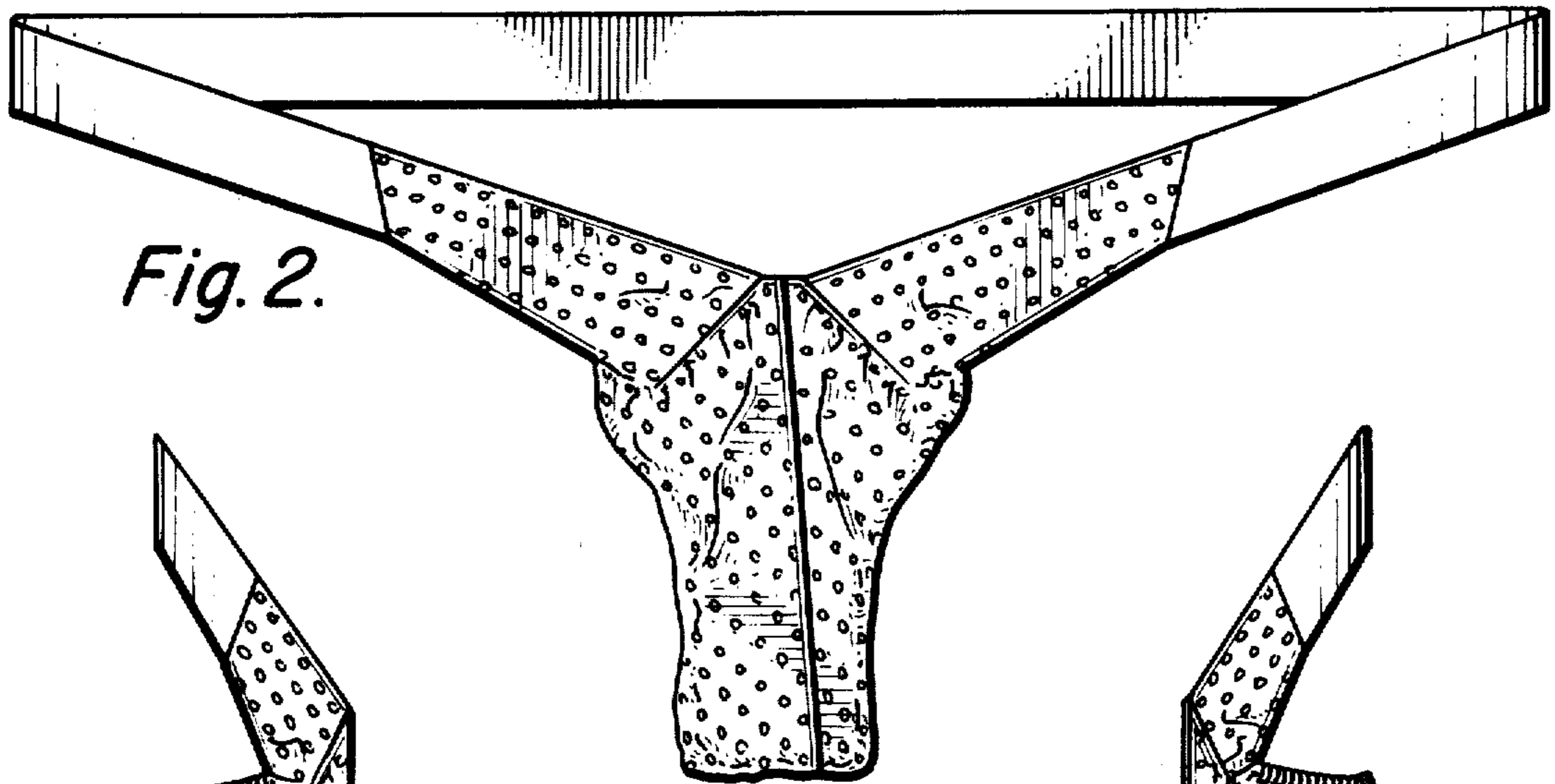

Fig. 2.

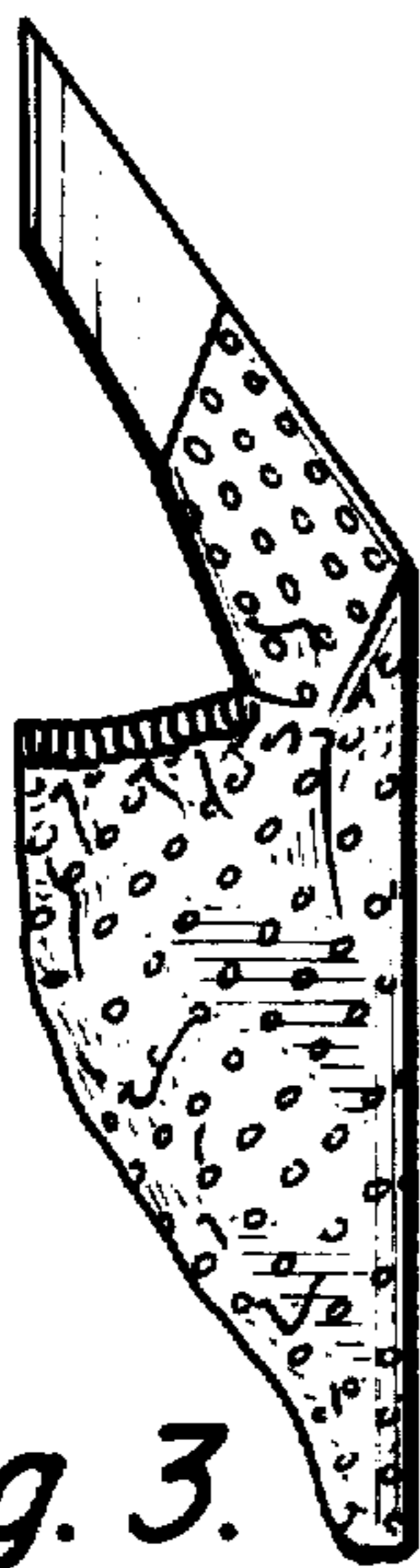

Fig. 3.



Fig. 4.

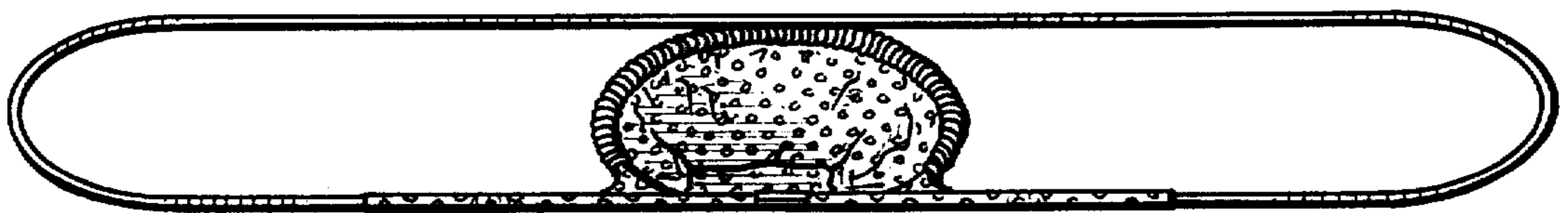

Fig. 5.

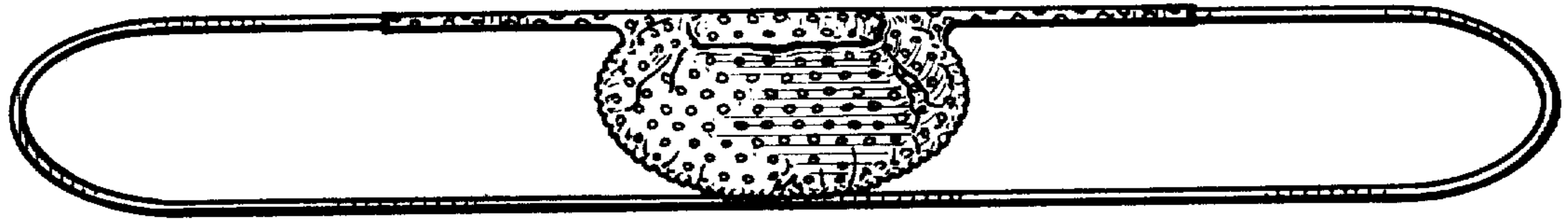

Fig. 6.

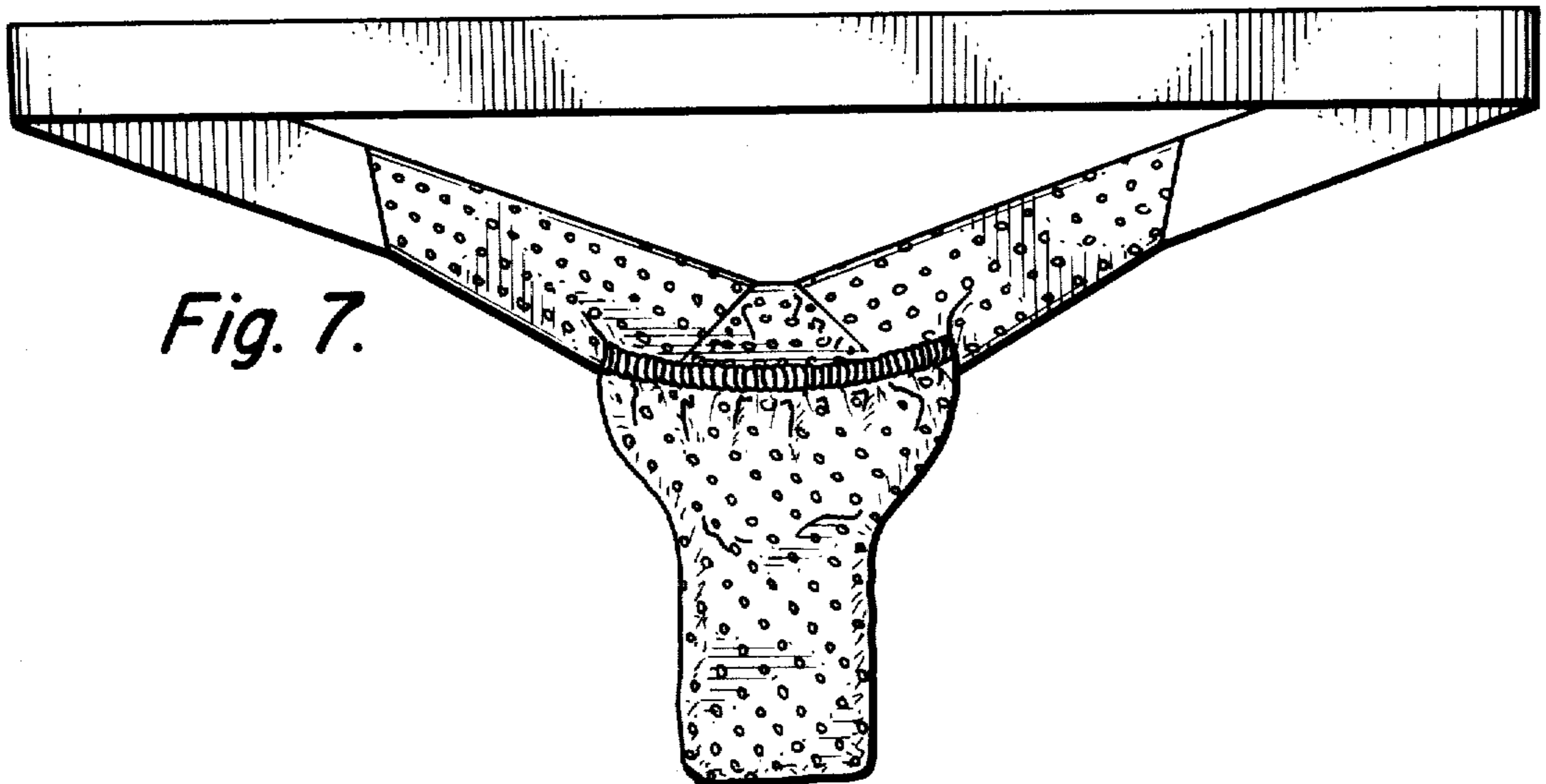

Fig. 7.

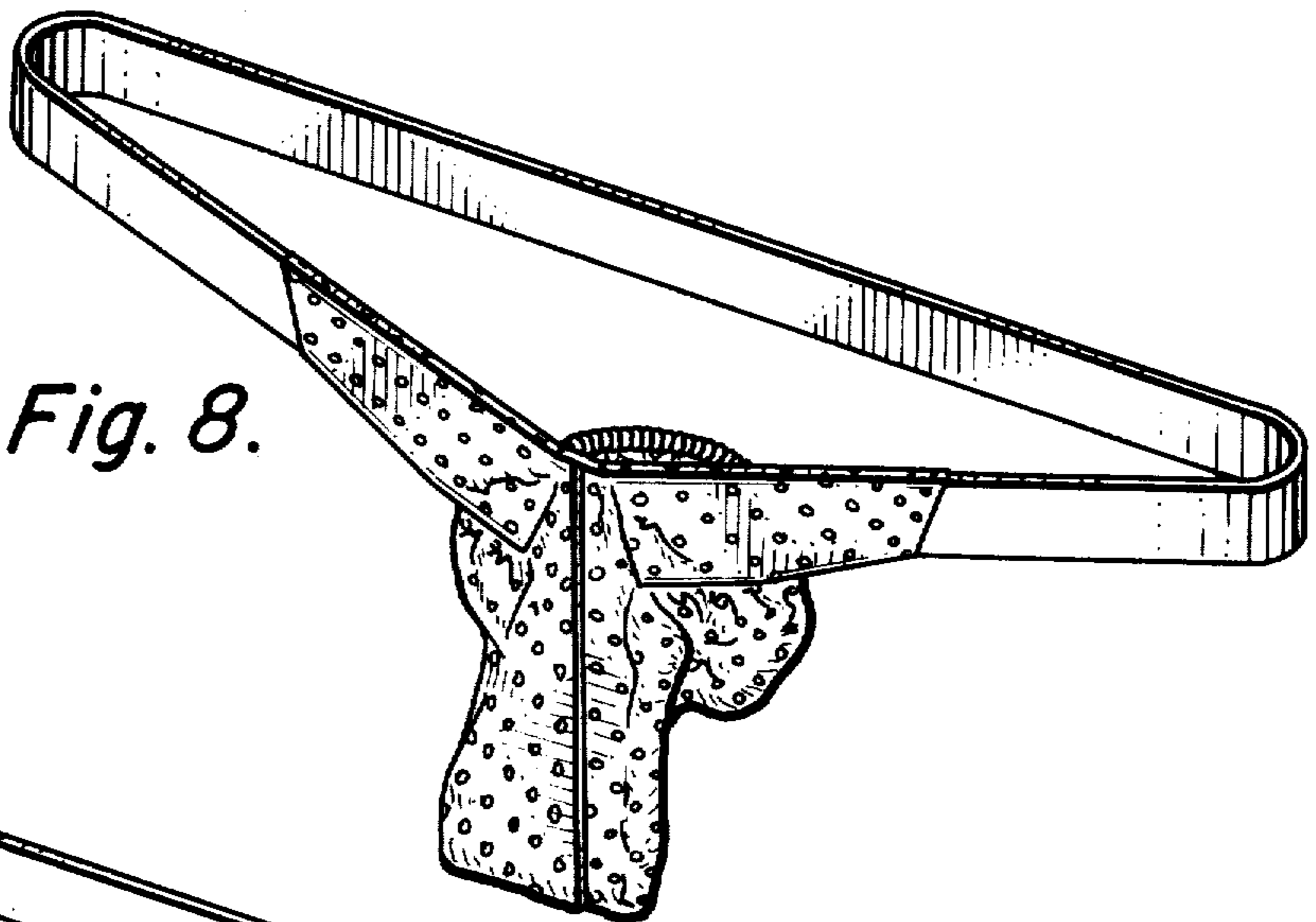

Fig. 8.

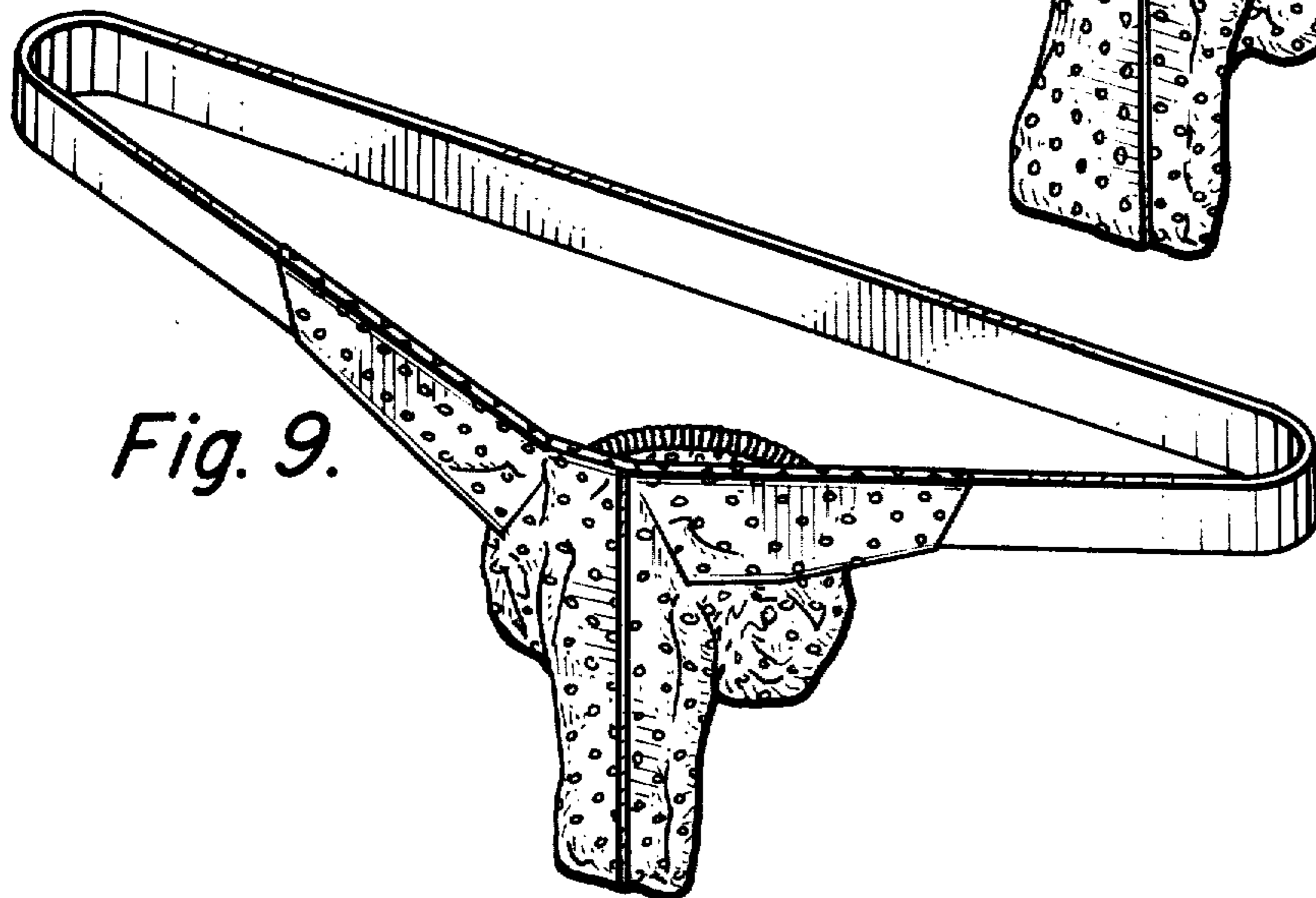

Fig. 9.