

[54] **MARKING INSTRUMENT**

[75] **Inventor:** **Günter Horntrich**, Pforzheim, Fed. Rep. of Germany

[73] **Assignee:** **Messrs. Kreuzer-Werk GmbH**, Bonn-Duisdorf, Fed. Rep. of Germany

[**] **Term:** **14 Years**

[21] **Appl. No.:** **253,362**

[22] **Filed:** **Apr. 13, 1981**

[30] **Foreign Application Priority Data**

Oct. 16, 1980 [DE] Fed. Rep. of Germany MR 1872

[51] **Int. Cl.** **D19-06**

[52] **U.S. Cl.** **D19/43; D19/48; D19/56; D19/57**

[58] **Field of Search** **D19/35, 36, 41-51, D19/54, 57; 401/195, 202, 262; D27/36**

[56] **References Cited**

U.S. PATENT DOCUMENTS

D. 235,883	7/1975	Stuetzer	D27/36
D. 260,272	8/1981	Horntrich	D19/57
D. 264,854	6/1982	Spiegel	D19/49
4,183,685	1/1980	Hofmann et al.	D19/43

OTHER PUBLICATIONS

Visual Systems Co. Inc., Cat. (c) 1978, p. 160-B, Item No. 7304P.

Primary Examiner—George P. Word

[57] **CLAIM**

The ornamental design for a marking instrument, as shown and described.

DESCRIPTION

FIG. 1 is a perspective view of a marking instrument showing my new design;

FIG. 2 is an exploded perspective view thereof;

FIG. 3 is a front elevational view thereof;

FIG. 4 is a right side elevational view thereof;

FIG. 5 is a left side elevational view thereof;

FIG. 6 is a rear elevational view thereof;

FIG. 7 is a top plan view thereof; and

FIG. 8 is a bottom plan view thereof.

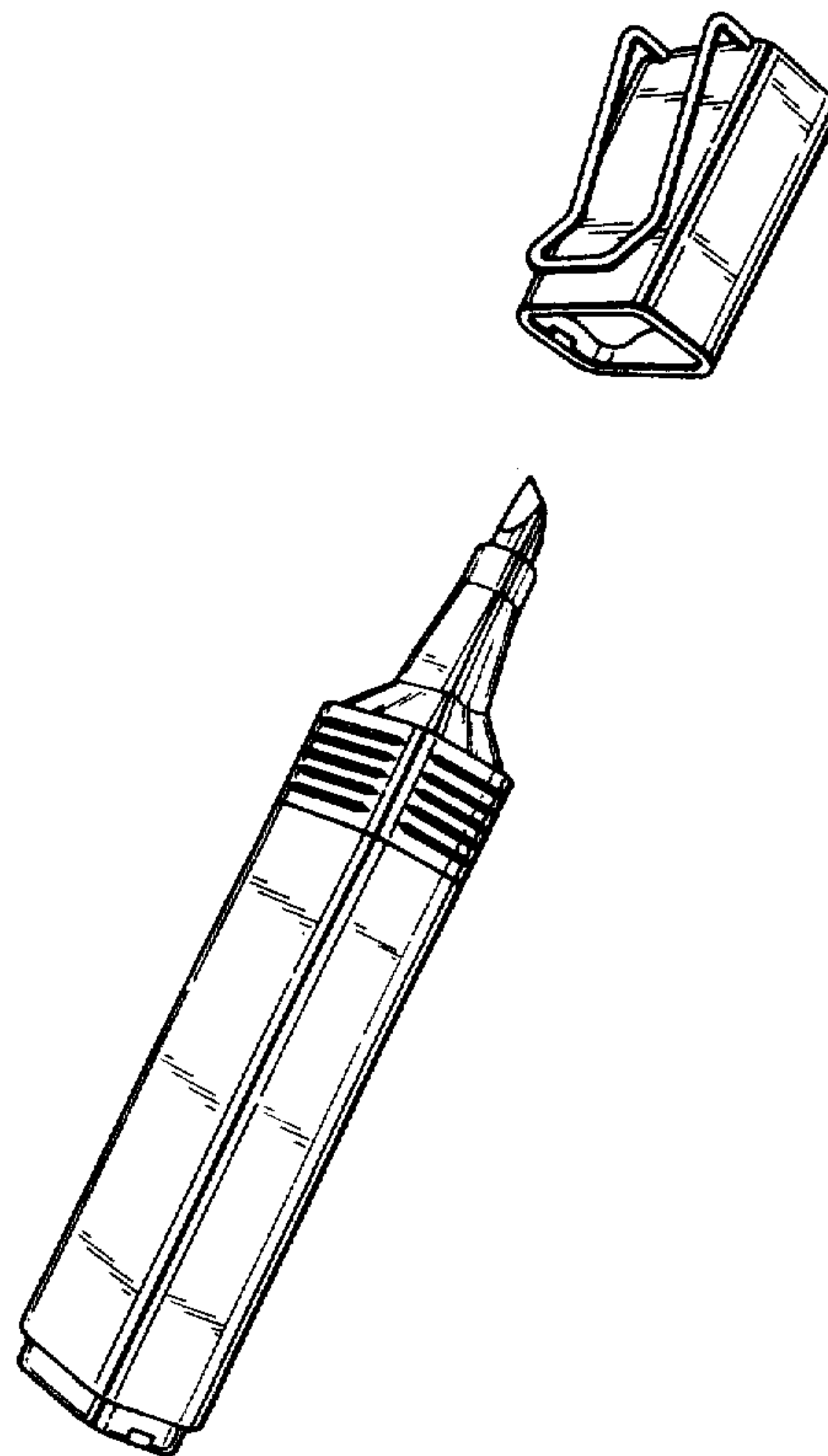

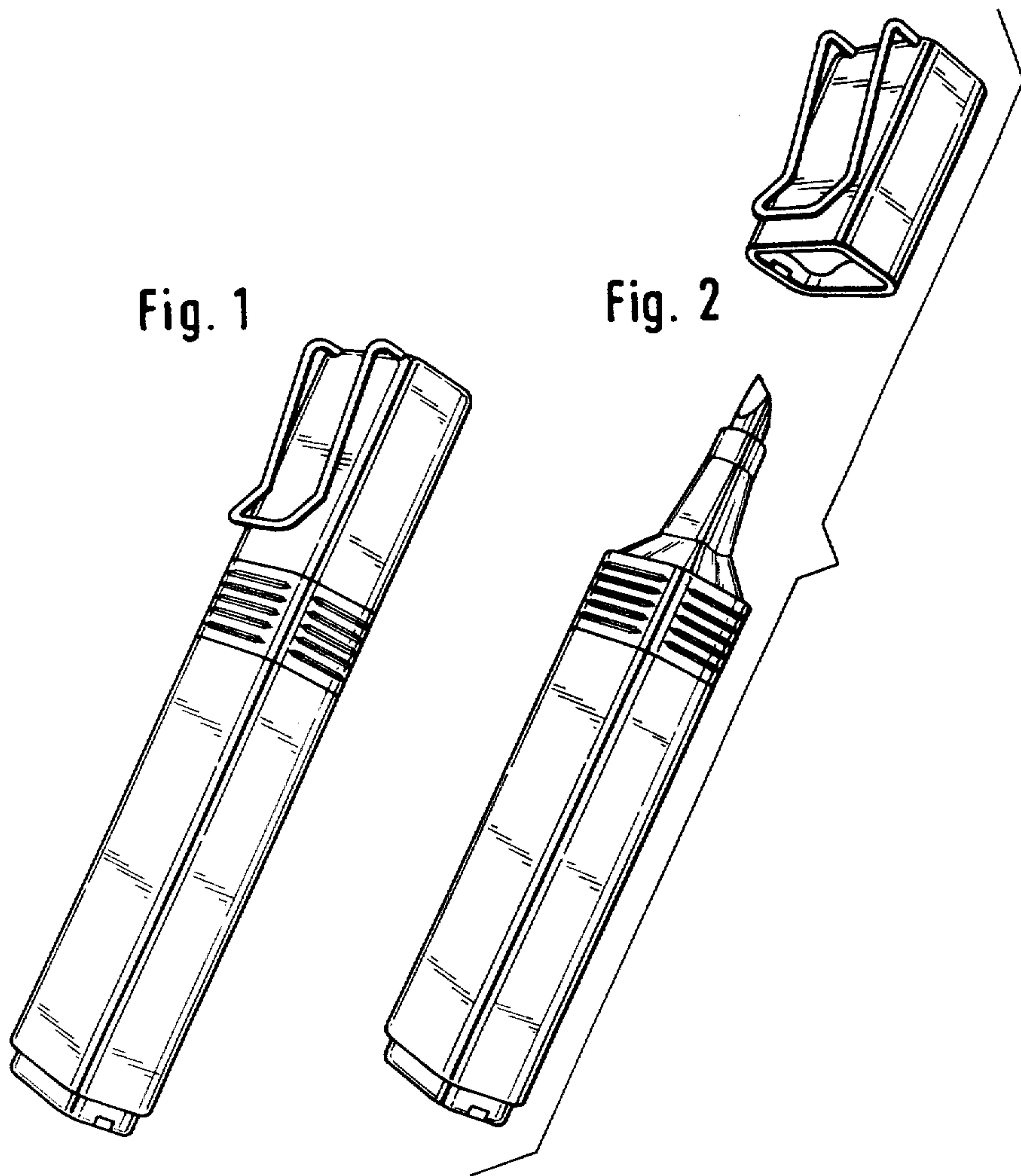

Fig. 1

Fig. 2

Fig. 8

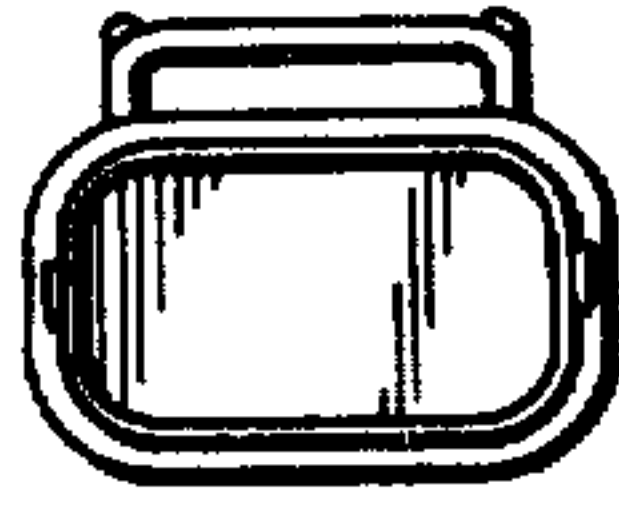

Fig. 4

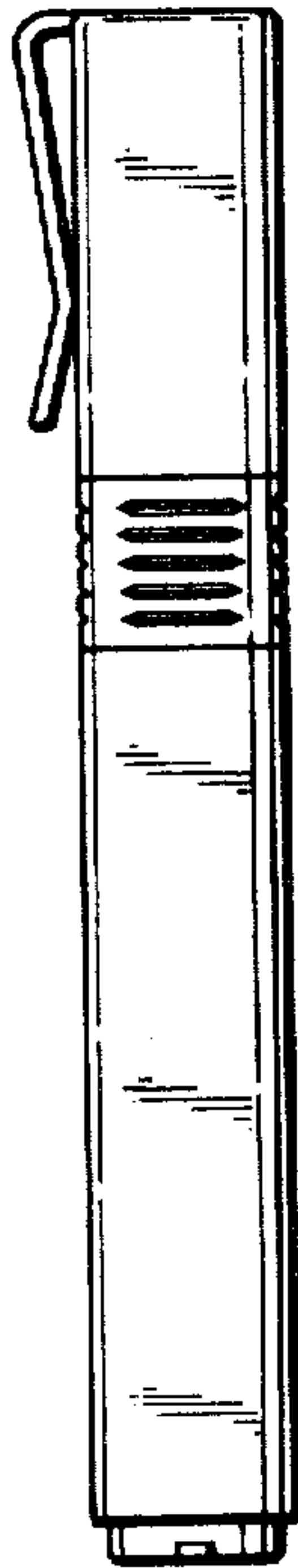

Fig. 3

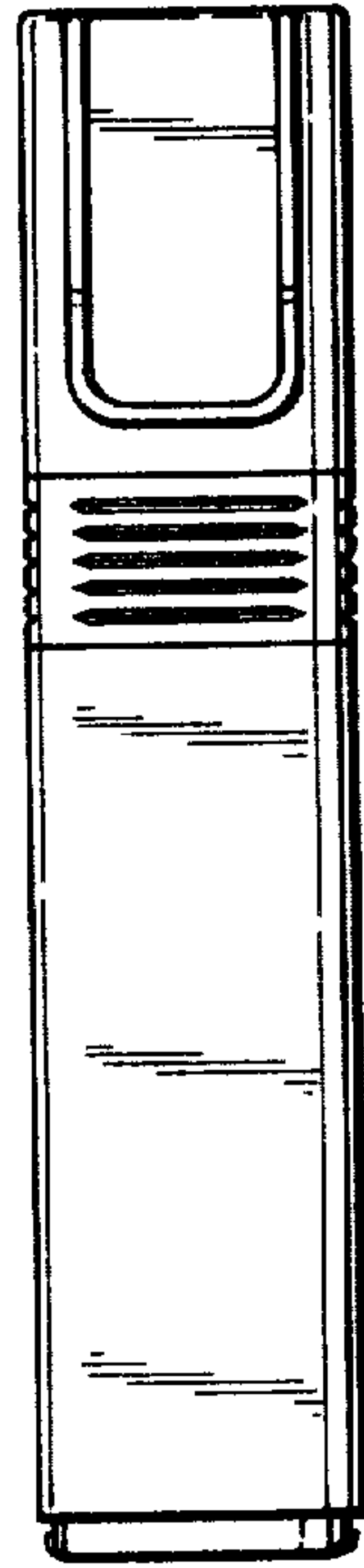

Fig. 5

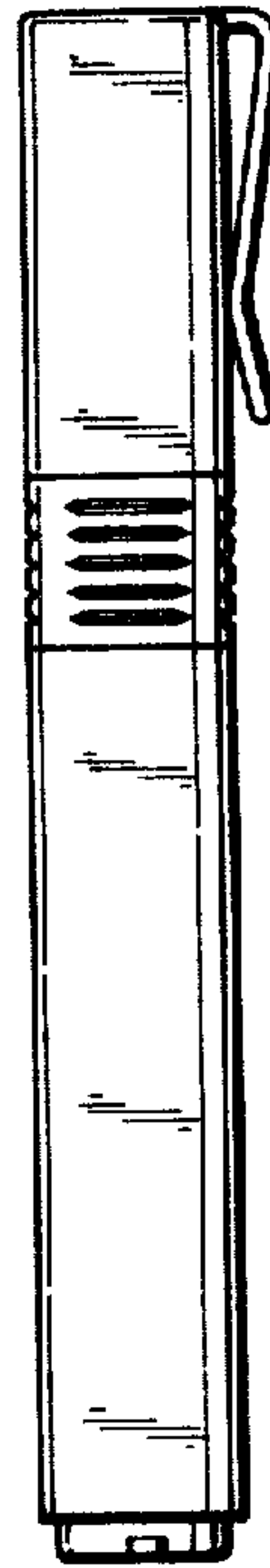

Fig. 6

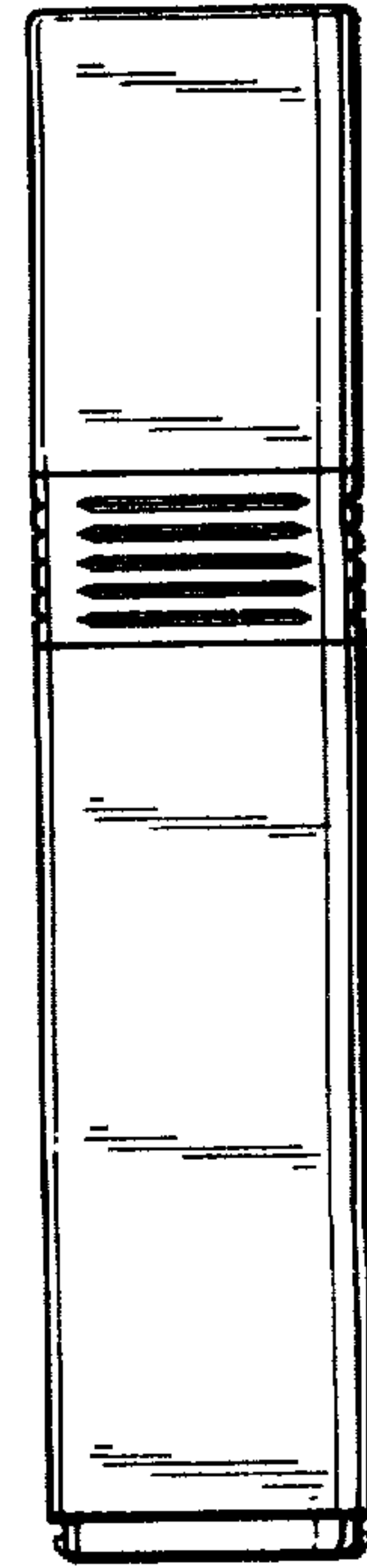

Fig. 7

