

[54] **SWING SEAT**

[76] **Inventor:** Jack F. Yevak, 715 Coronet, San Antonio, Tex. 78216

[**] **Term:** 14 Years

[21] **Appl. No.:** 233,005

[22] **Filed:** Feb. 9, 1981

[51] **Int. Cl.** D21-03

[52] **U.S. Cl.** D21/246

[58] **Field of Search** D21/246, 243, 242, 244;
272/85-92

[56] **References Cited**
PUBLICATIONS

Everwear Cat. No. 40, Playground Apparatus, p. 9, middle left, Swing Seat.

Game-Time Cat. 966, 1965, p. 12, upper right, Swing Seat No. 350.

Primary Examiner—Melvin B. Feifer
Attorney, Agent, or Firm—Gale R. Peterson

[57] **CLAIM**

The ornamental design for swing seat, as shown.

DESCRIPTION

FIG. 1 is a top view of the swing seat showing my new design.

FIG. 2 is a front view thereof.

FIG. 3 is a bottom view thereof.

FIG. 4 is an end view taken from the left of FIG. 2.

FIG. 5 is an end view taken from the right of FIG. 2.

FIG. 6 is a rear view thereof.

FIG. 7 is an enlarged perspective view thereof.

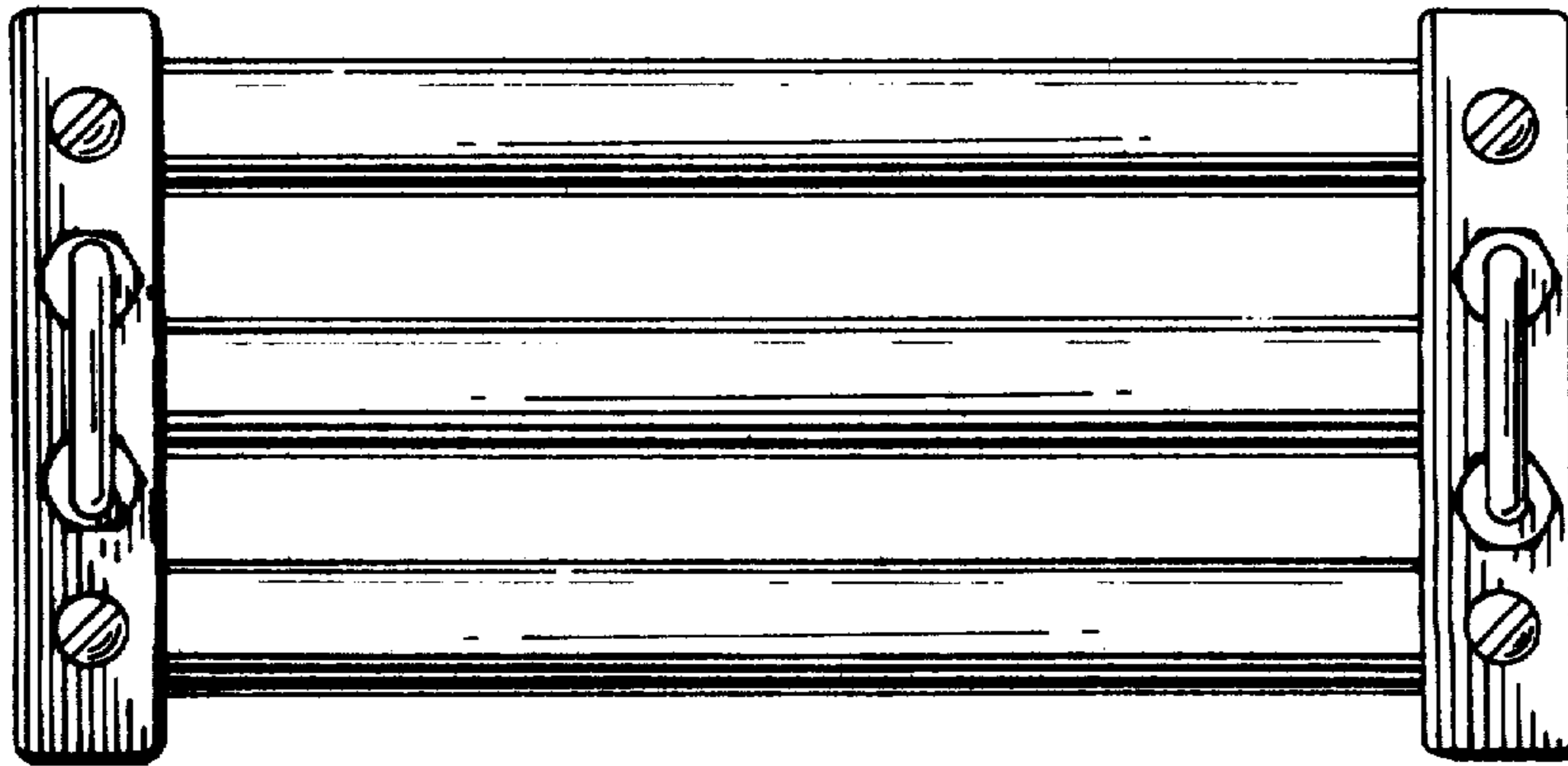



FIG. 1

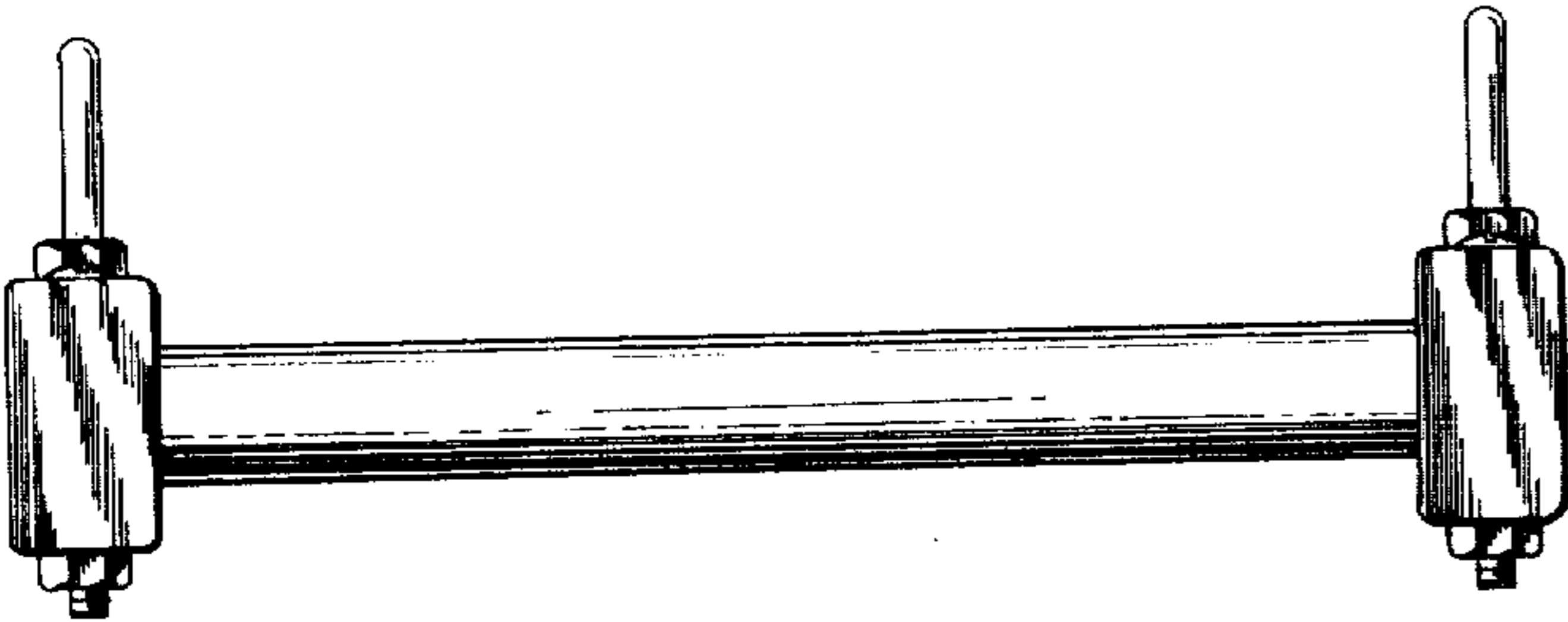

FIG. 2

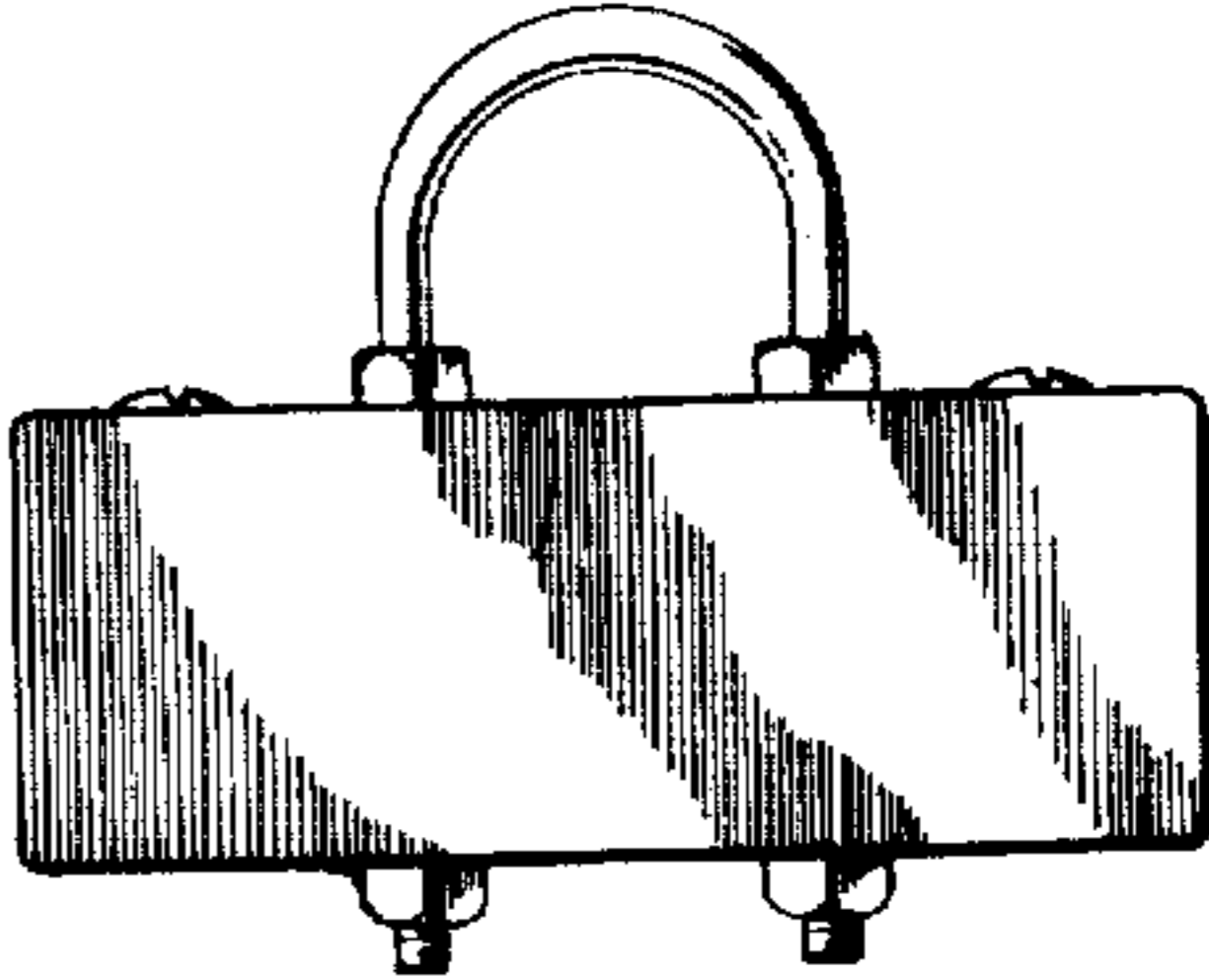

FIG. 4

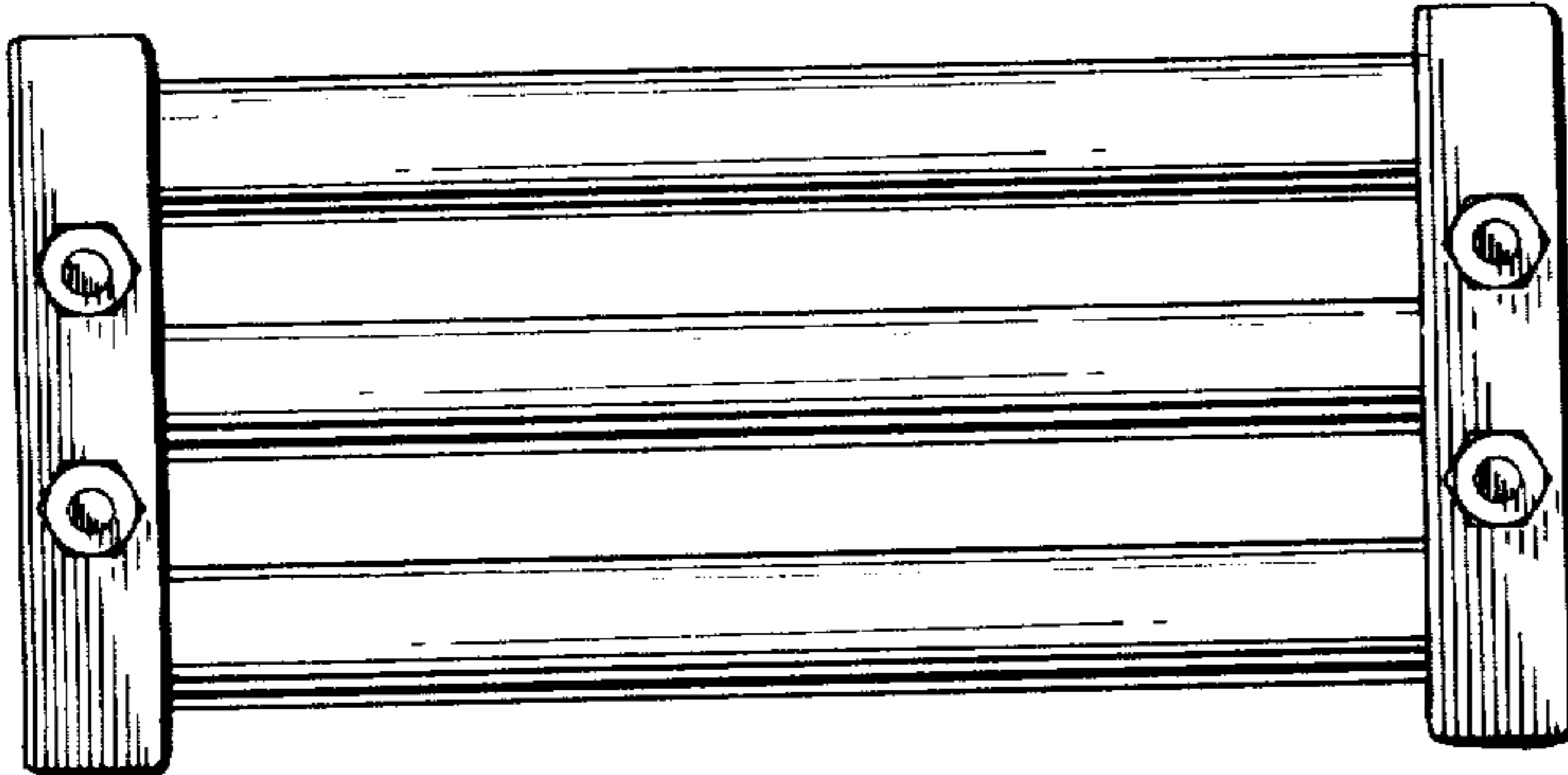

FIG. 3

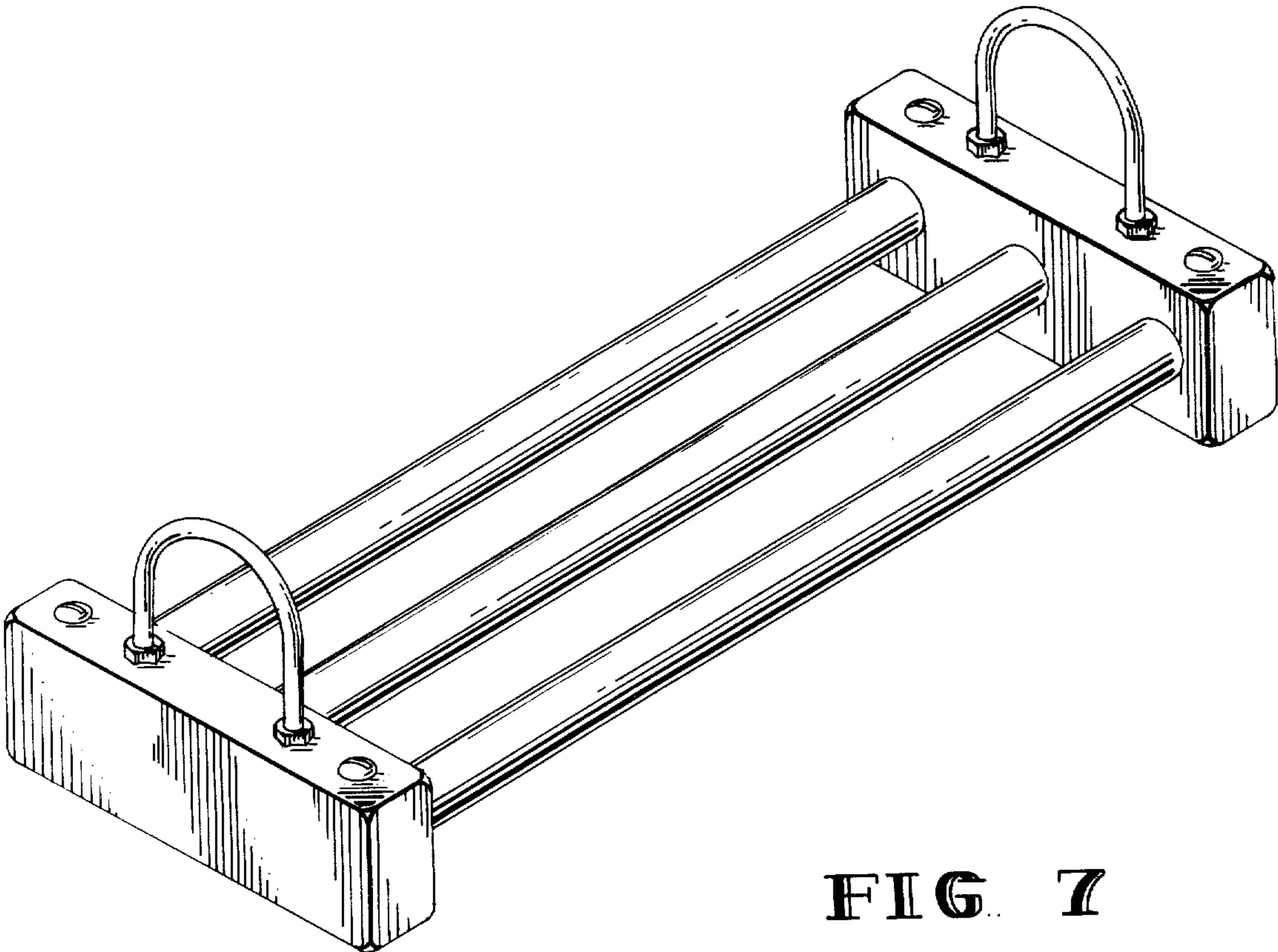

FIG. 7

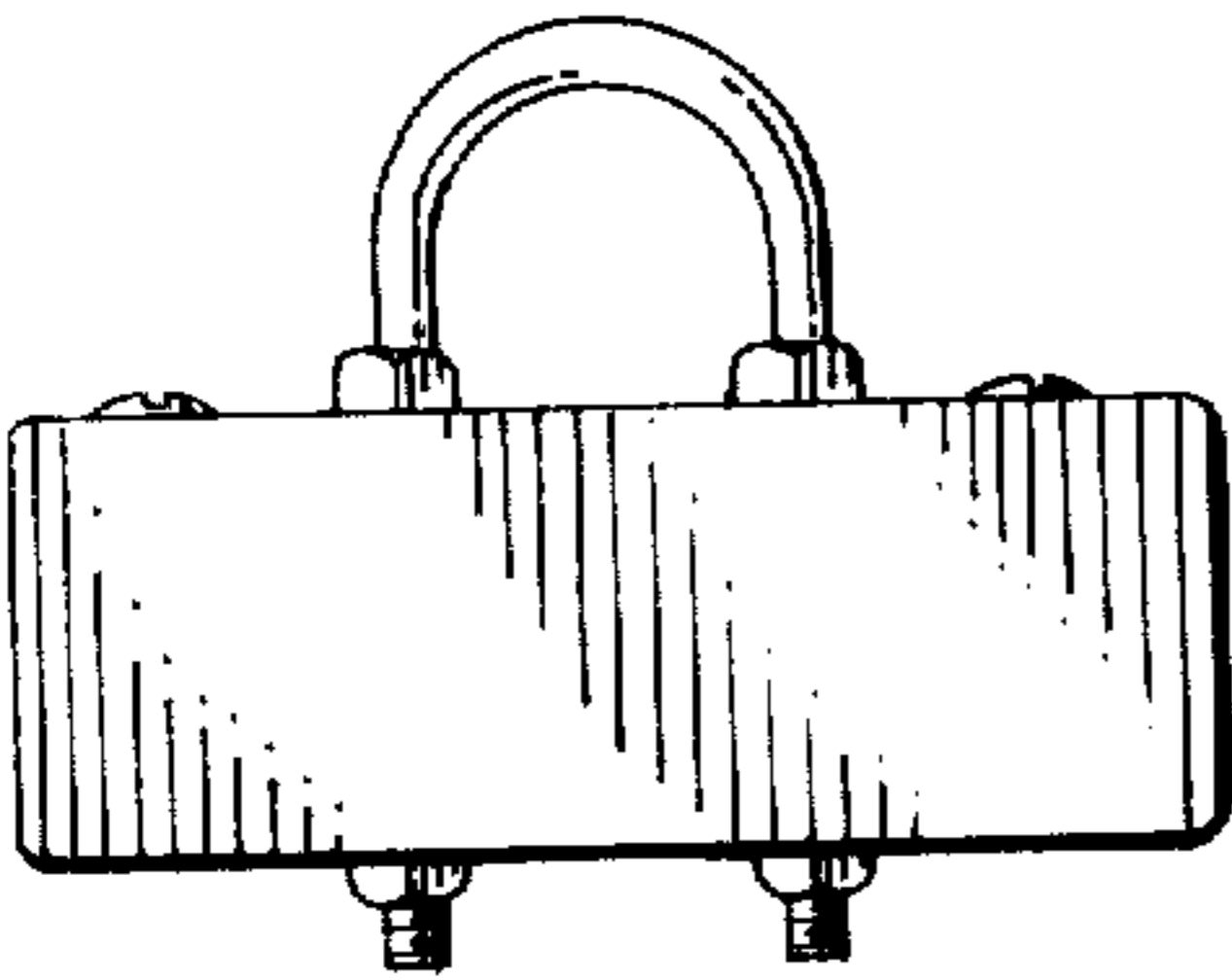

FIG. 5

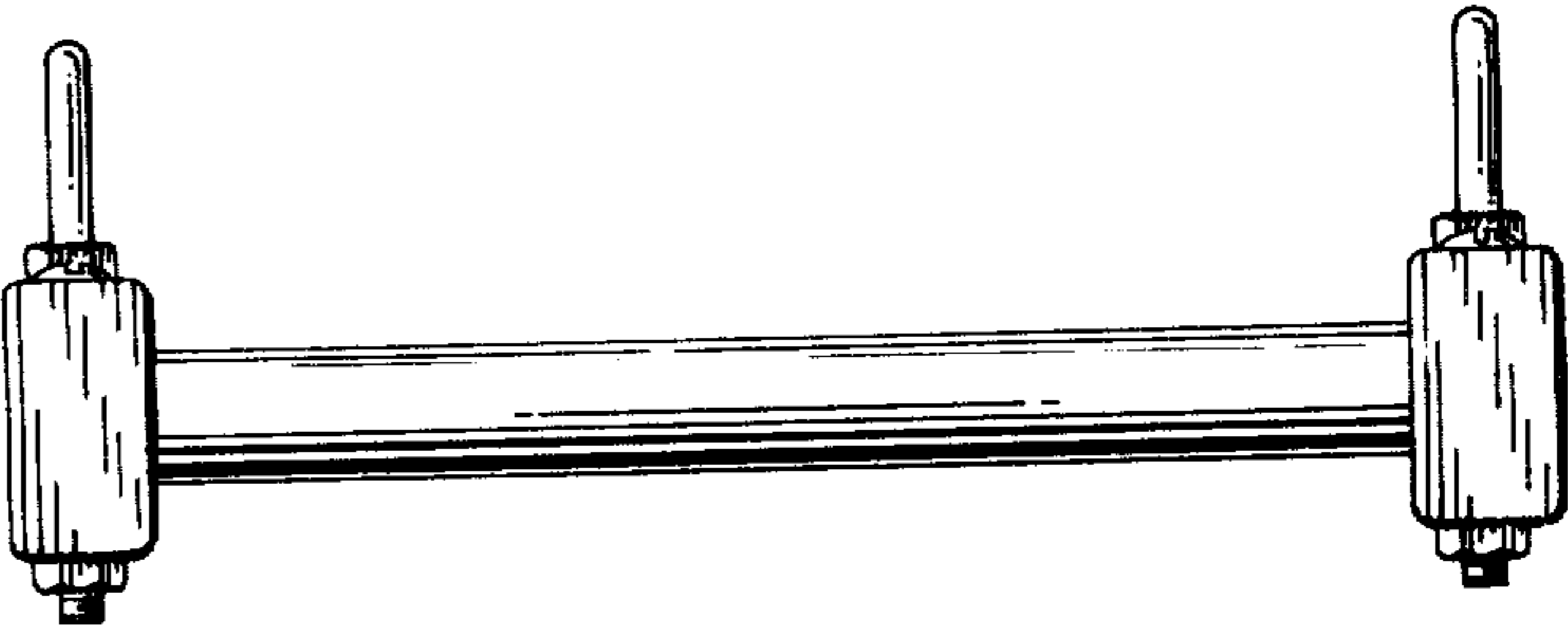

FIG. 6