

[54] SWIVEL CHAIR

[75] Inventor: J. Thayer Coggin, High Point, N.C.

[73] Assignee: Thayer Coggin Incorporated, High Point, N.C.

[**] Term: 14 Years

[21] Appl. No.: 28,489

[22] Filed: Apr. 9, 1979

[51] Int. Cl. D6-01
[52] U.S. Cl. D6/26; D6/71
[58] Field of Search D6/26, 30, 31, 37-39,
D6/47-78

[56] References Cited

U.S. PATENT DOCUMENTS

D. 258,100 2/1981 Blowers D6/26

OTHER PUBLICATIONS

Interiors, 9/72, p. 74, bottom center, Chair by Domore. Selig Monroe Catalog, p. M6A, Swivel Chair No. 232-14.

Primary Examiner—Bruce W. Dunkins
Attorney, Agent, or Firm—Schuyler, Banner, Birch, McKie and Beckett

[57] CLAIM

The ornamental design for a swivel chair, as shown and described.

DESCRIPTION

FIG. 1 is a perspective view of my new design for a swivel chair;
FIG. 2 is a side elevational view thereof, the opposite side being the mirror image of that shown;
FIG. 3 is a front elevational view thereof;
FIG. 4 is a rear elevational view thereof;
FIG. 5 is a top plan view thereof; and
FIG. 6 is a bottom plan view thereof.

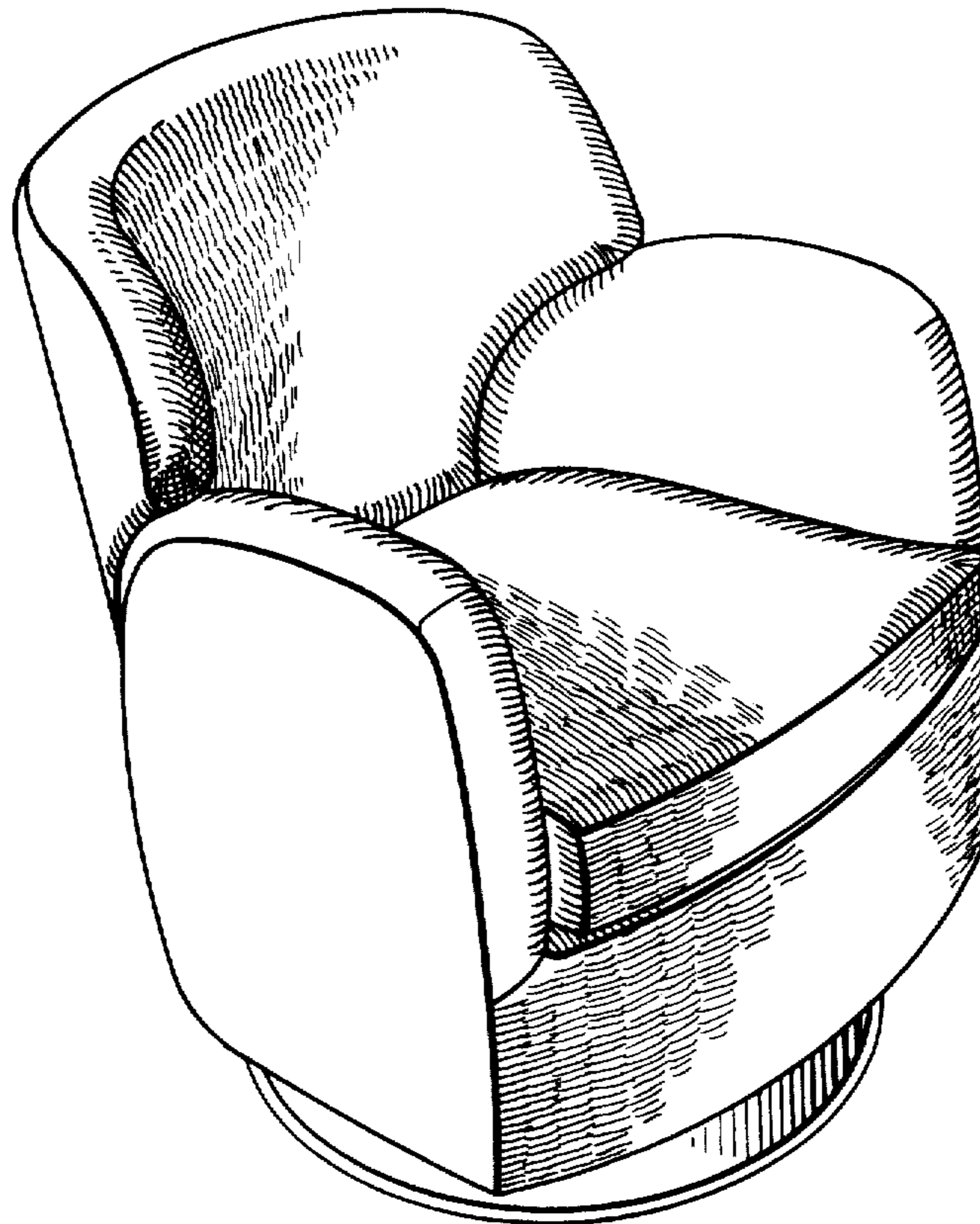

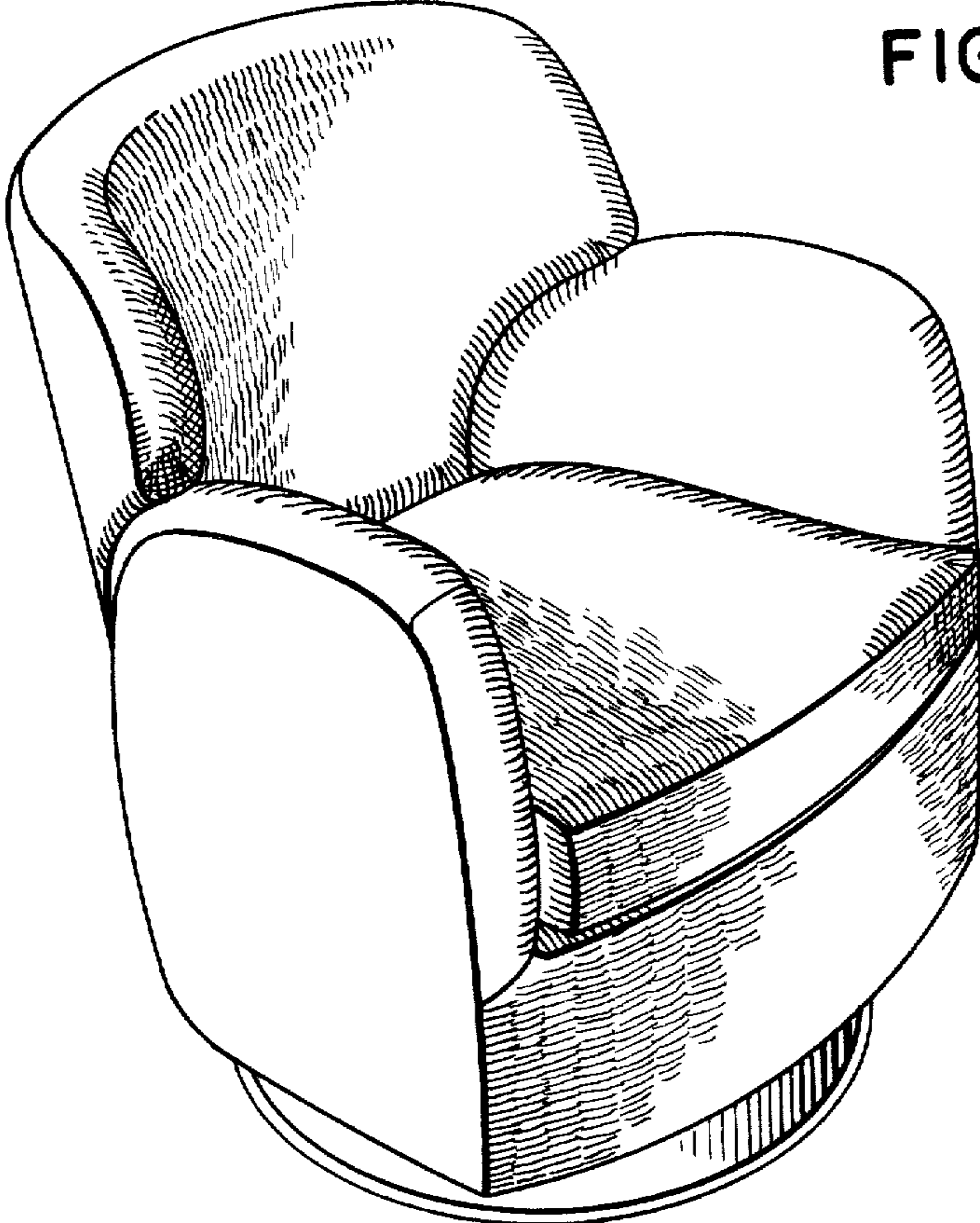

FIG. 1

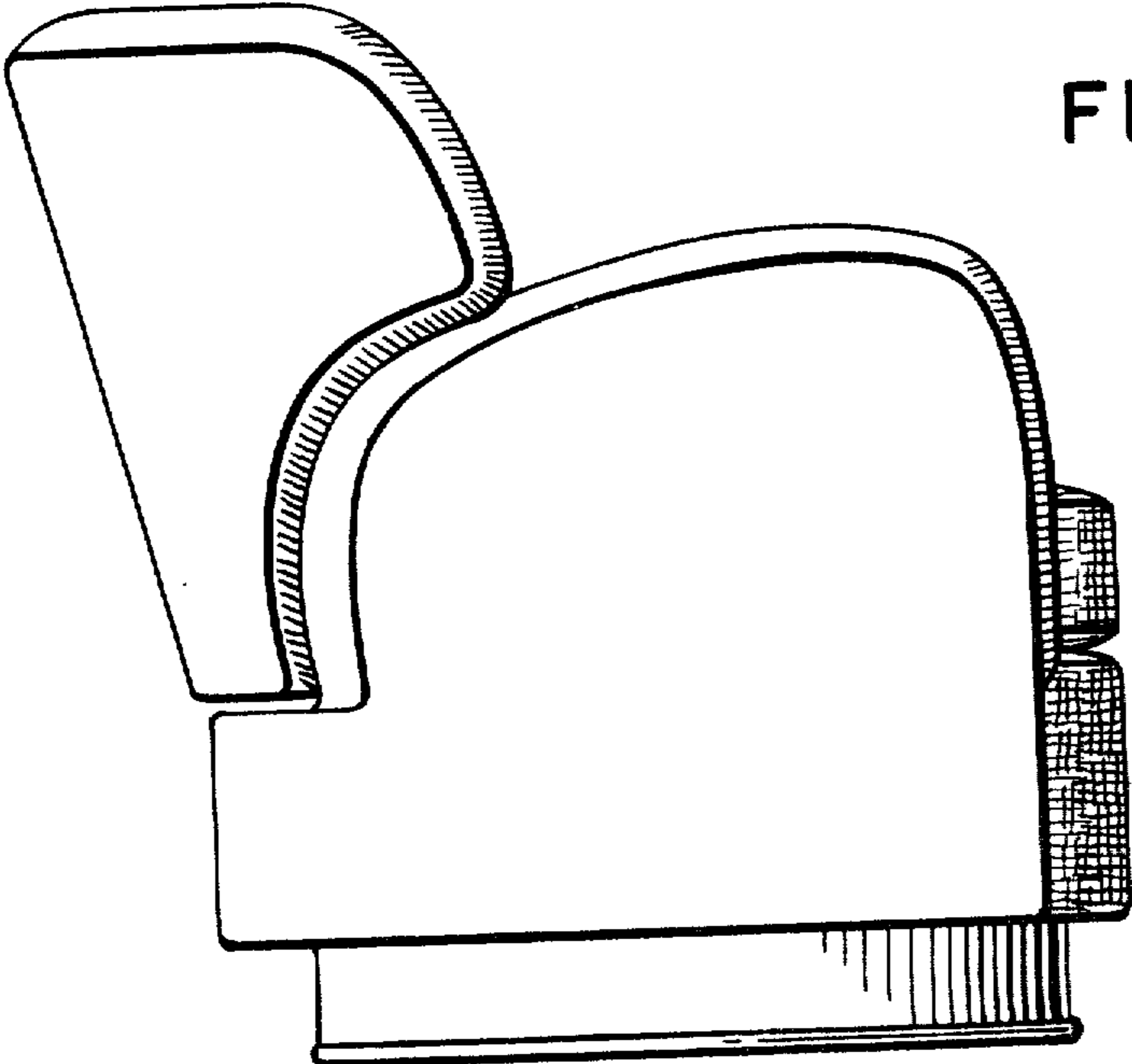

FIG. 2

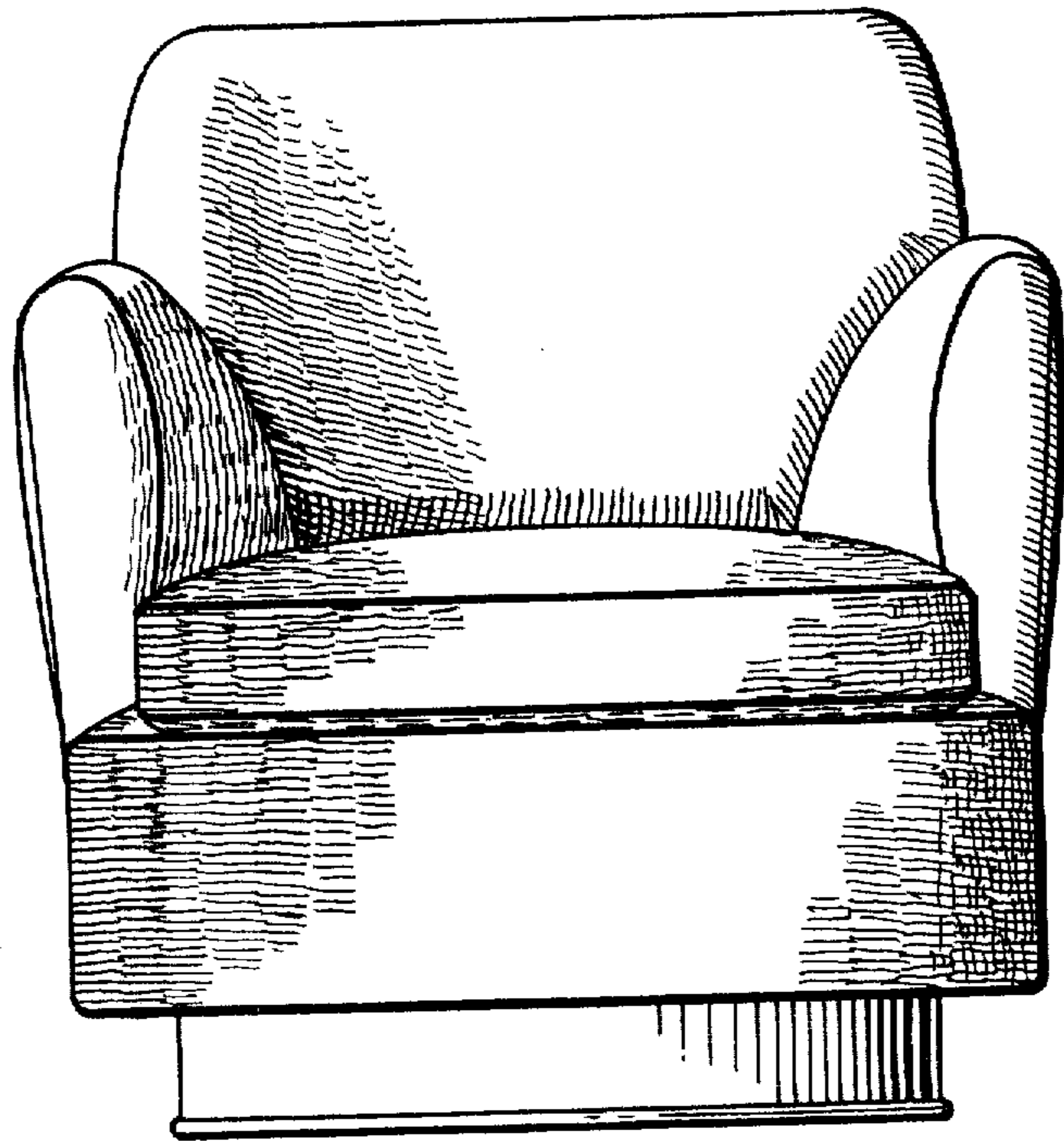

FIG. 3

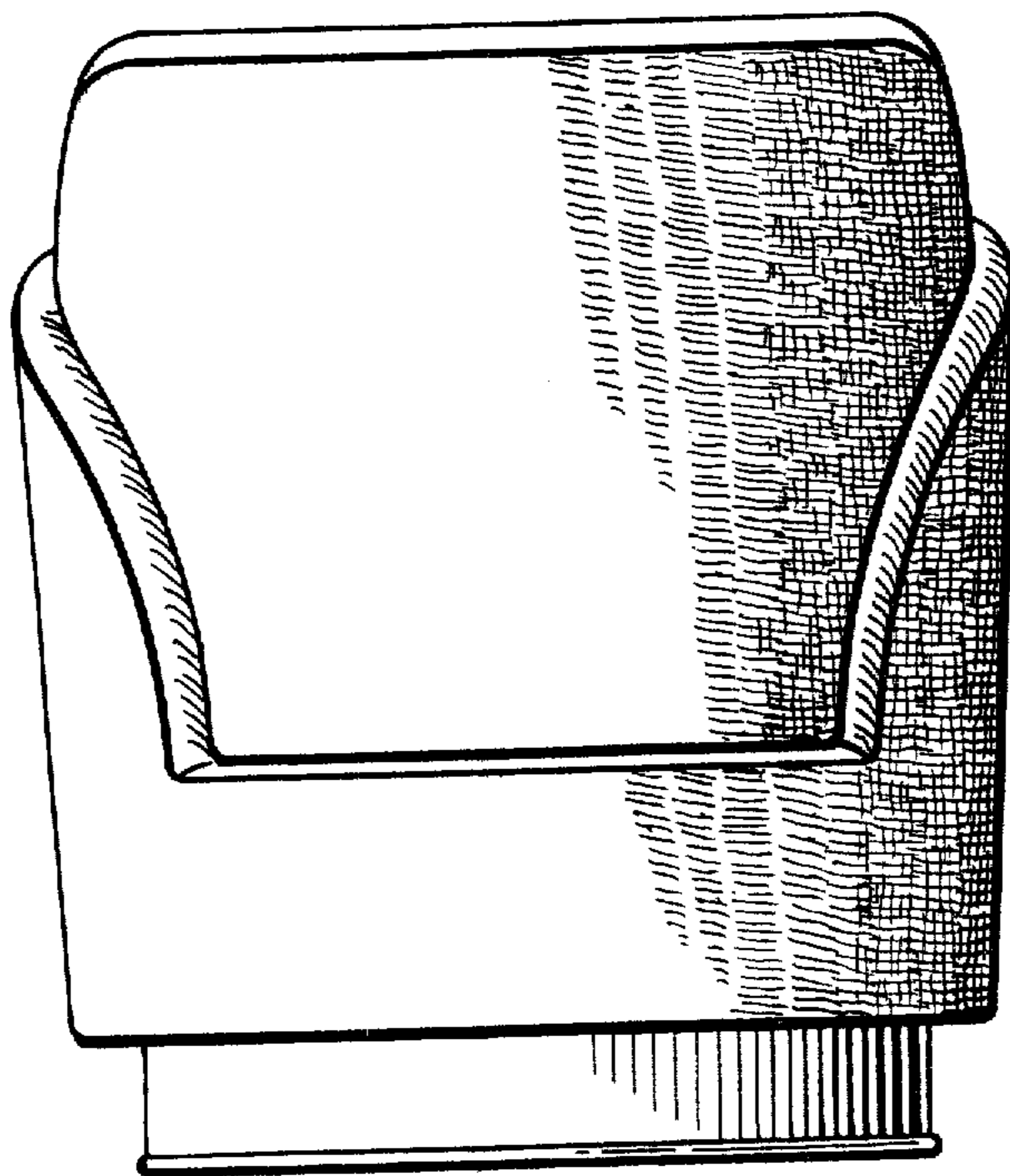

FIG. 4

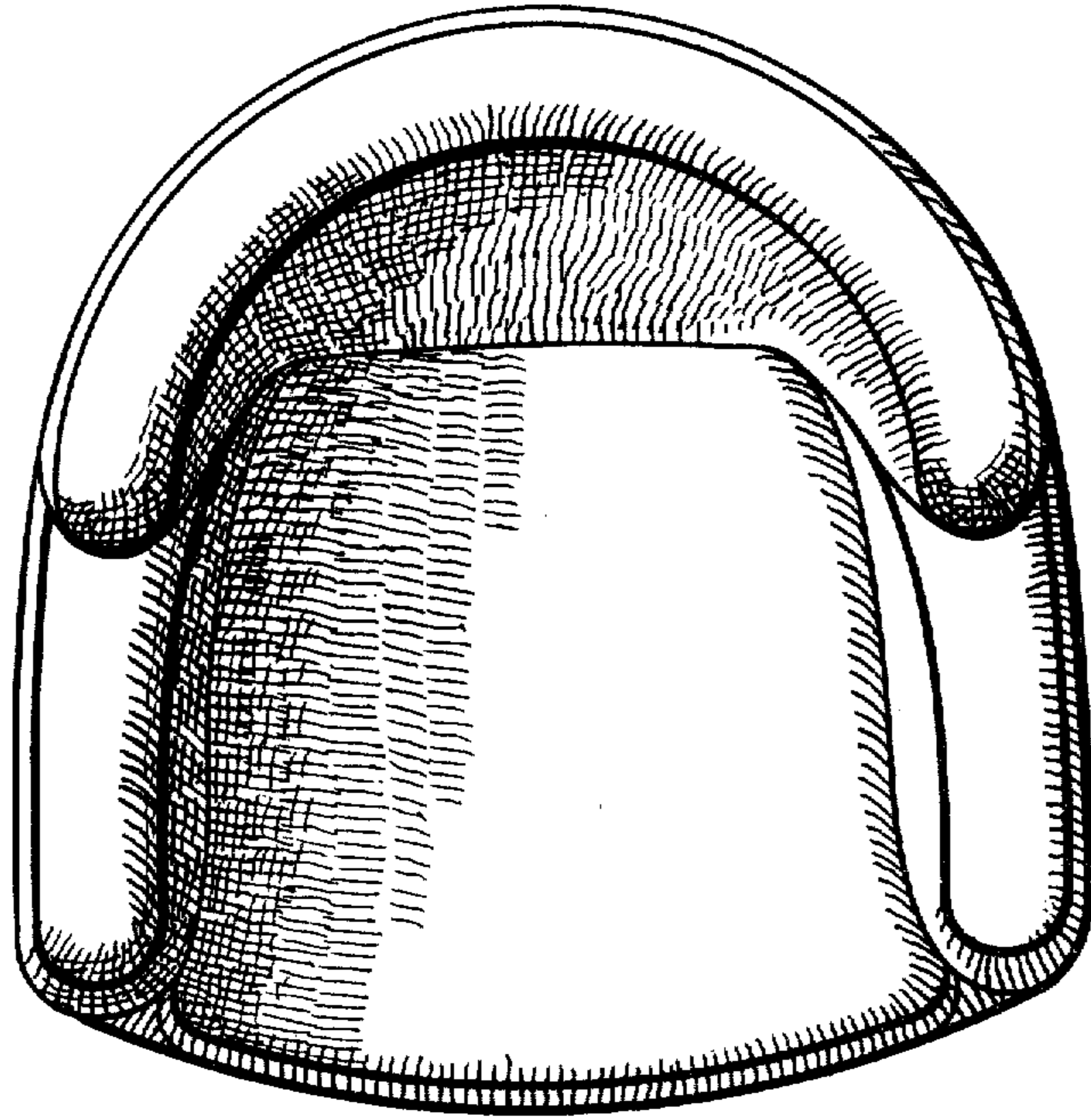

FIG. 5

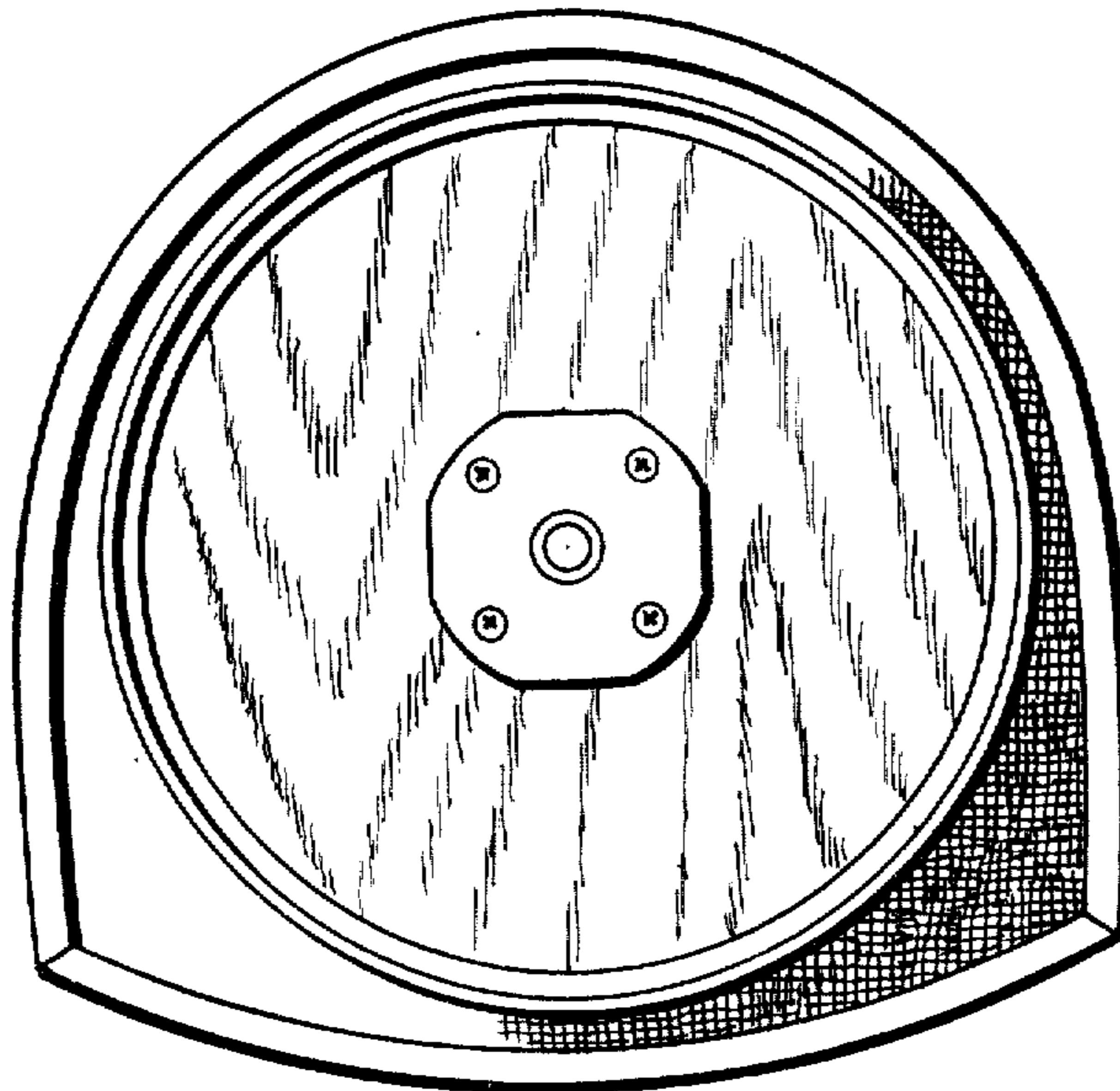

FIG. 6