

[54] CARRY CASE FOR SMALL ARTICLES

[76] Inventor: Robert Weinreb, 510 Broadway, New York, N.Y. 10012

[**] Term: 14 Years

[21] Appl. No.: 150,428

[22] Filed: May 16, 1980

[51] Int. Cl. D3-02

[52] U.S. Cl. D3/33; D3/71

[58] Field of Search D3/30, 33, 35, 36, 42, D3/48, 53, 71, 74, 79; 150/52 R, 52 J; 190/41 Z

[56] References Cited

U.S. PATENT DOCUMENTS

D. 240,468	7/1976	Ainslie	D3/33
D. 258,702	3/1981	Weinreb	D3/33
3,001,566	9/1961	Lipsitz	D3/33
4,260,004	4/1981	Domke	D3/33

Primary Examiner—George P. Word
Attorney, Agent, or Firm—Jacobs & Jacobs

[57] CLAIM

The ornamental design for a carry case for small articles, as shown and described.

DESCRIPTION

FIG. 1 is a perspective view of a carry case for small articles, showing my new design, with a portion of the strap broken away to show the top opening;

FIG. 2 is a front elevational view;

FIG. 3 is a rear elevational view;

FIG. 4 is a right side elevational view;

FIG. 5 is a left side elevational view;

FIG. 6 is a top plan view with a portion of the strap broken away and omitted to show the top opening;

FIG. 7 is a bottom plan view; and

FIG. 8 is a perspective view thereof, with the top and side compartments open, and a portion of the carrying strap broken away and omitted for convenience of illustration.

Partial showing of surface shading indicating a fabric texture is understood to be continuous on those surfaces where shown.

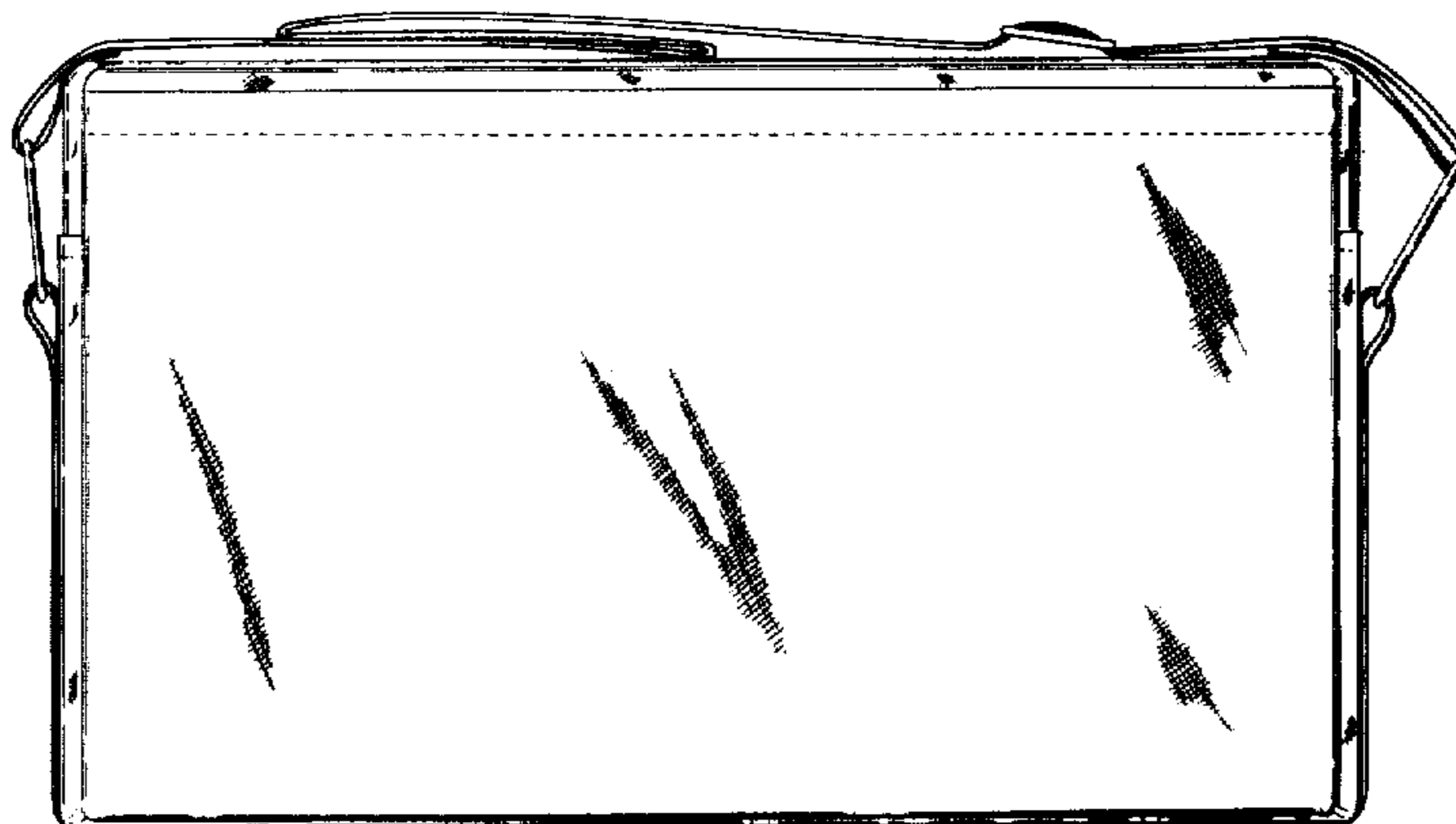
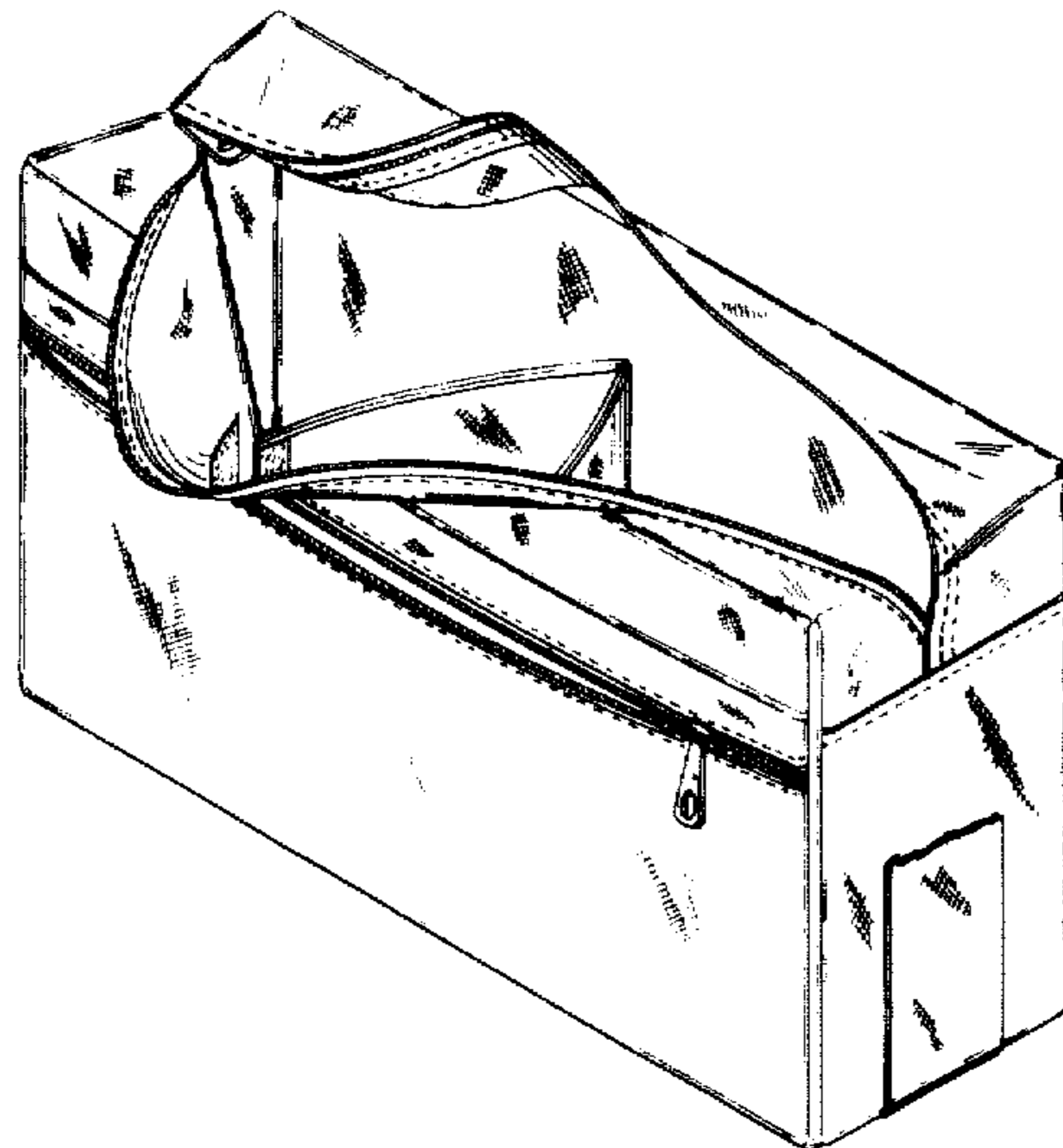

FIG. 1

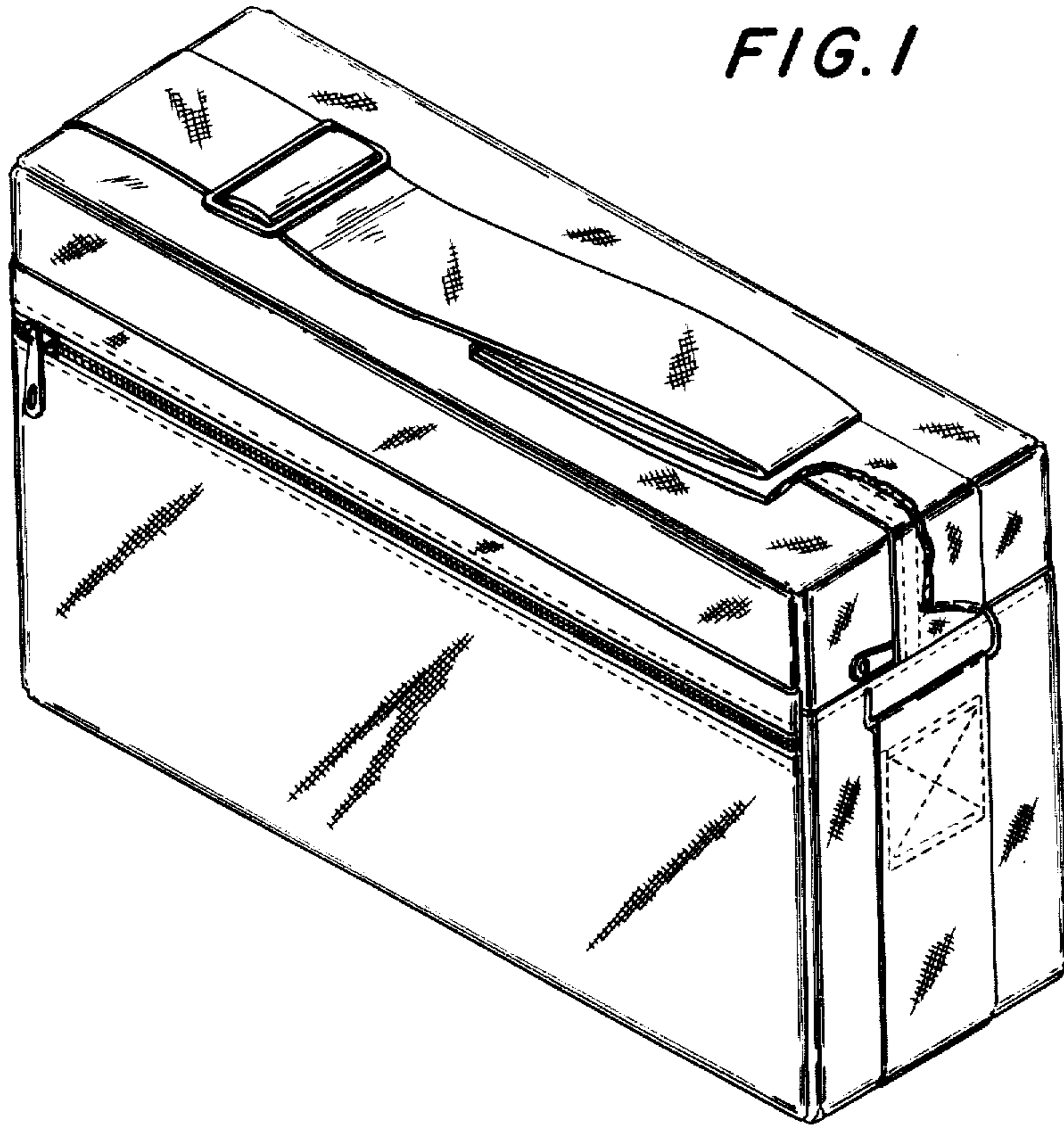

FIG. 2

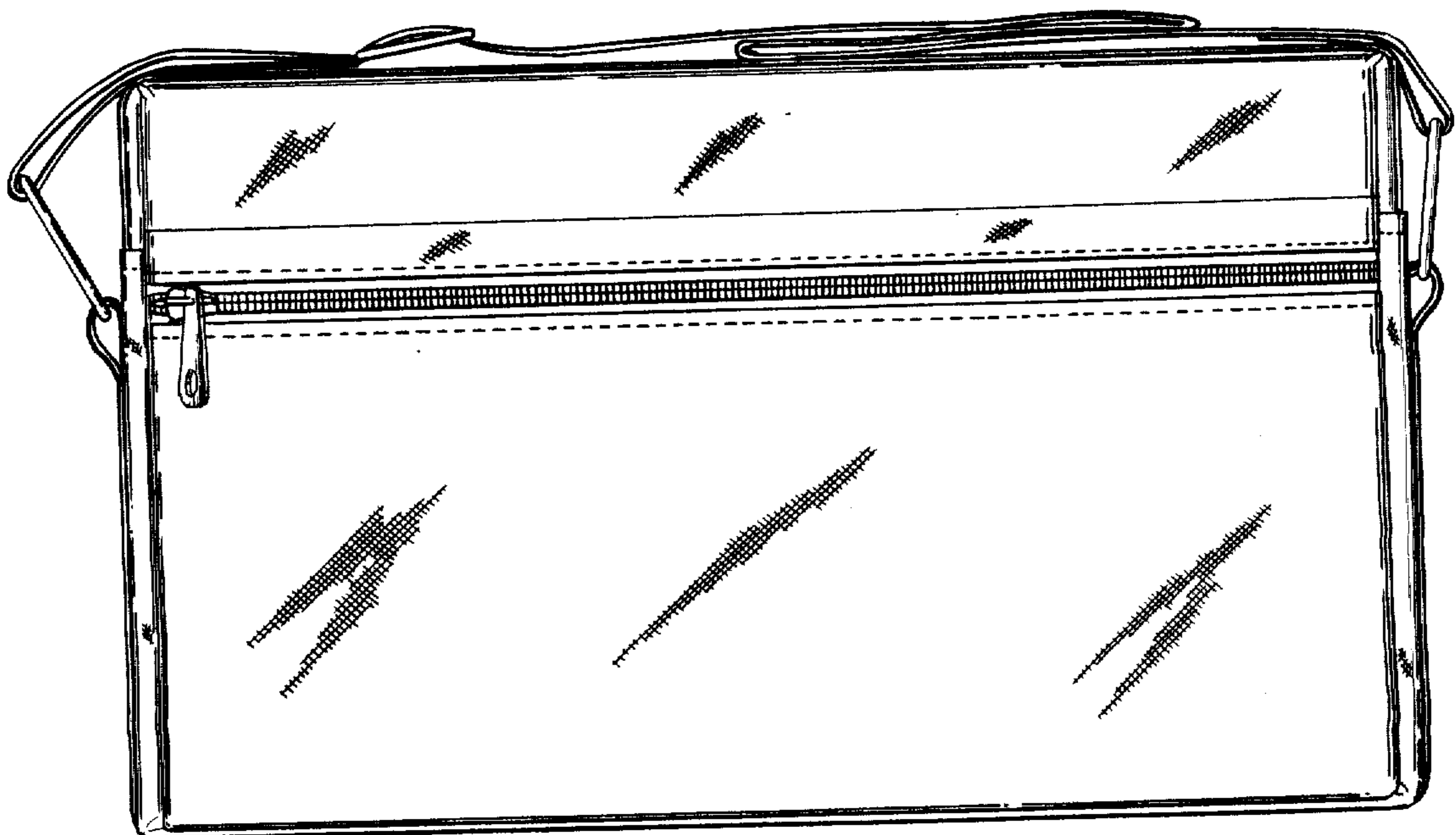

FIG. 8

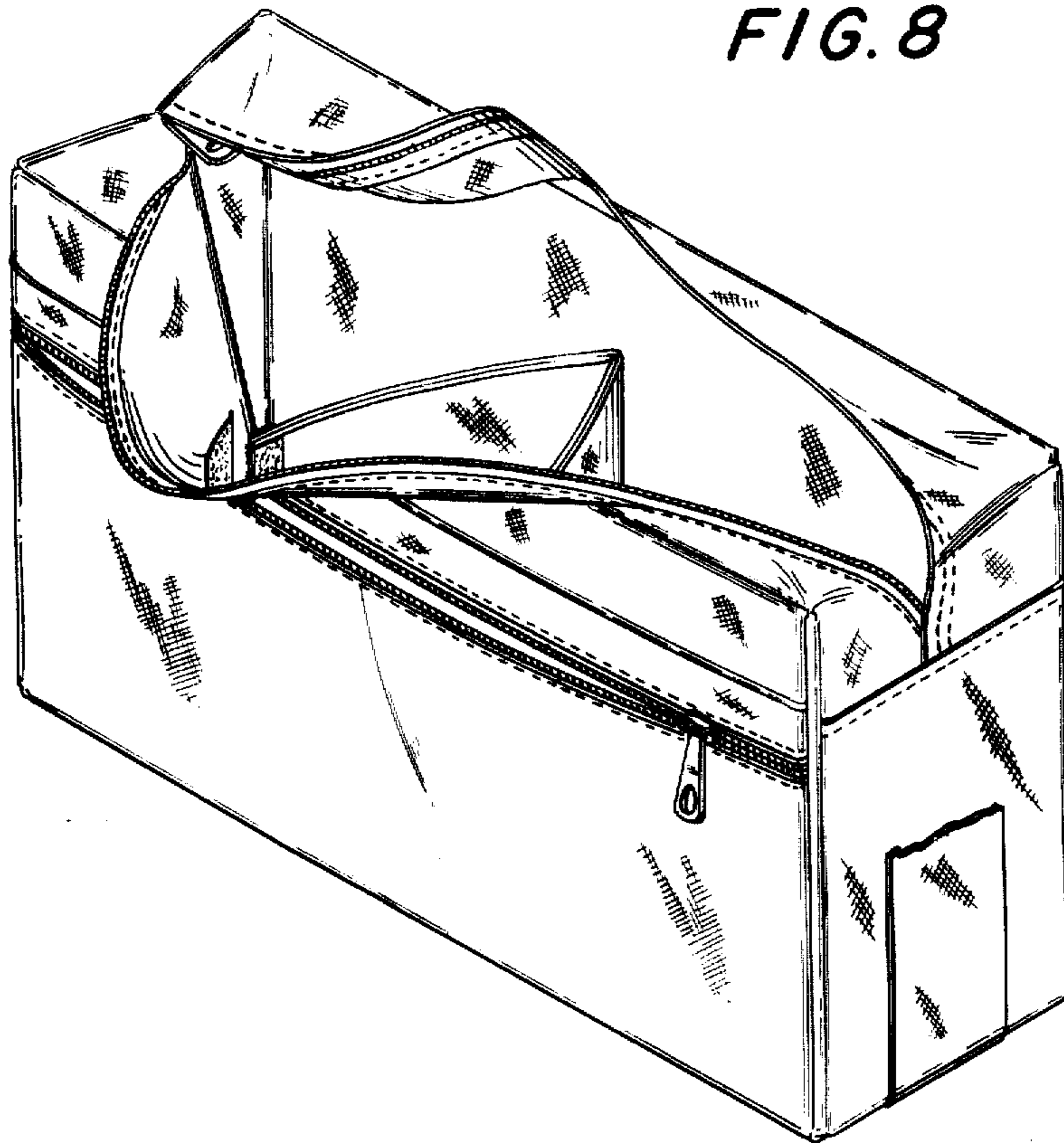

FIG. 3

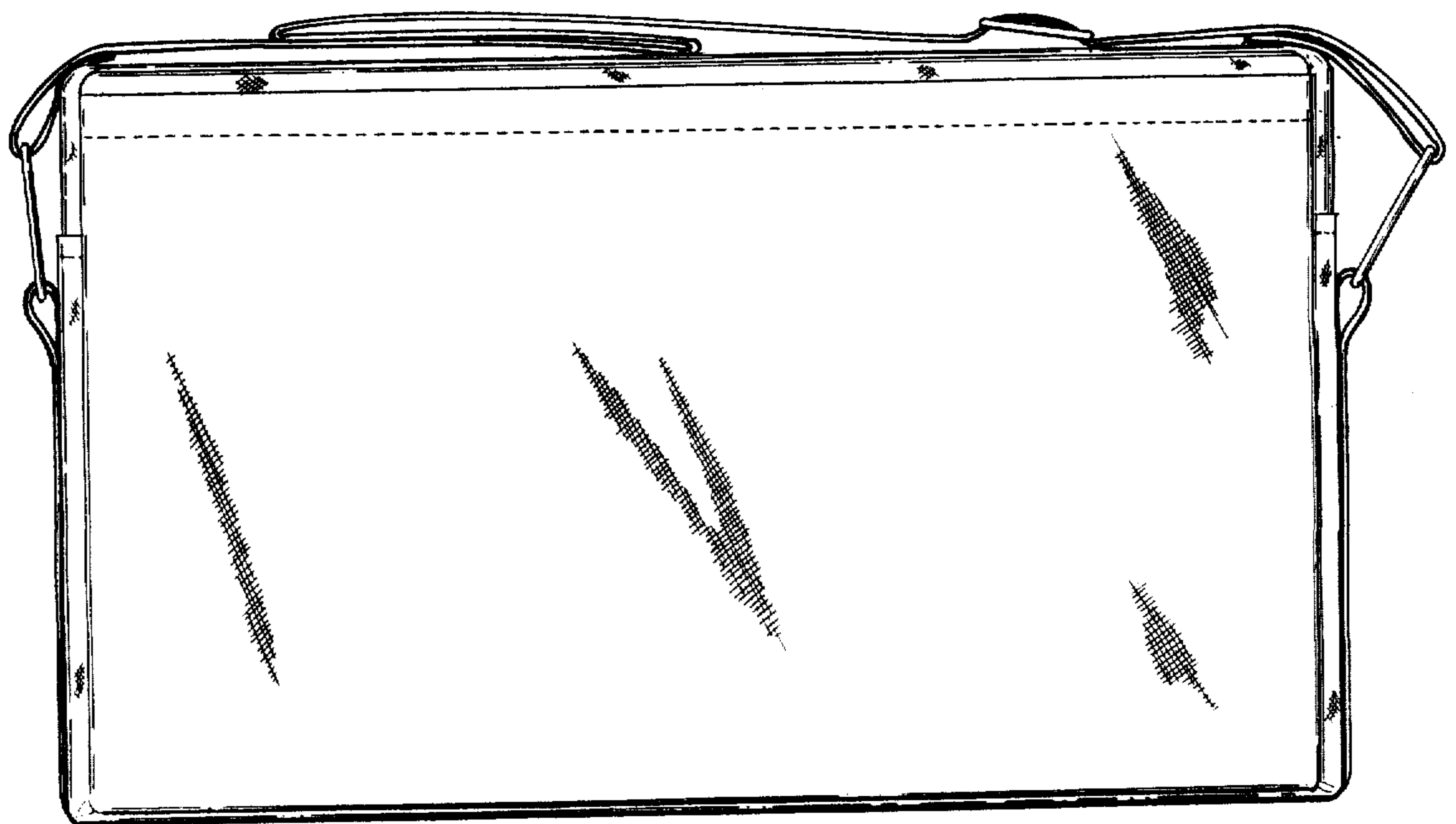

FIG. 4

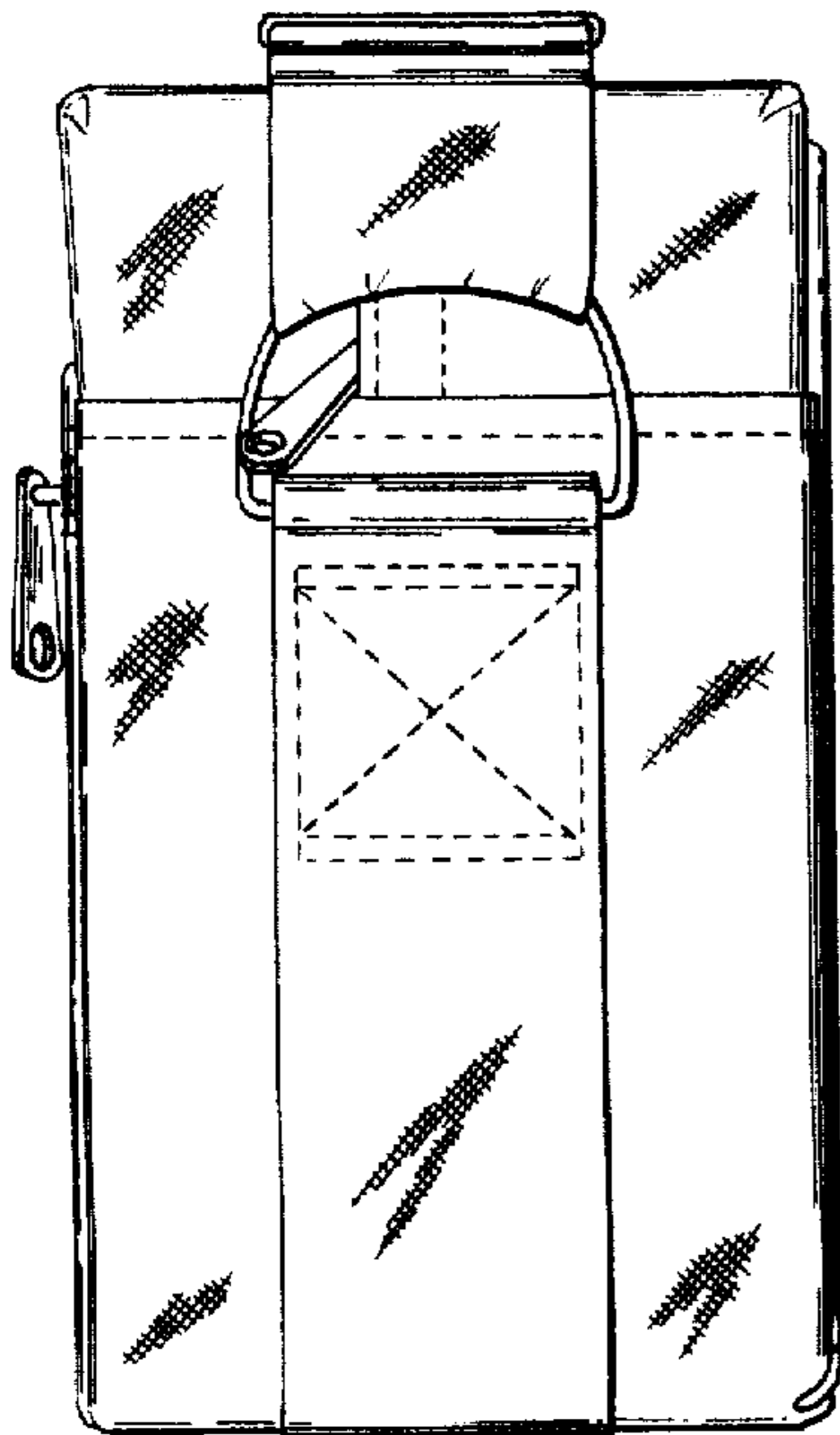

FIG. 5

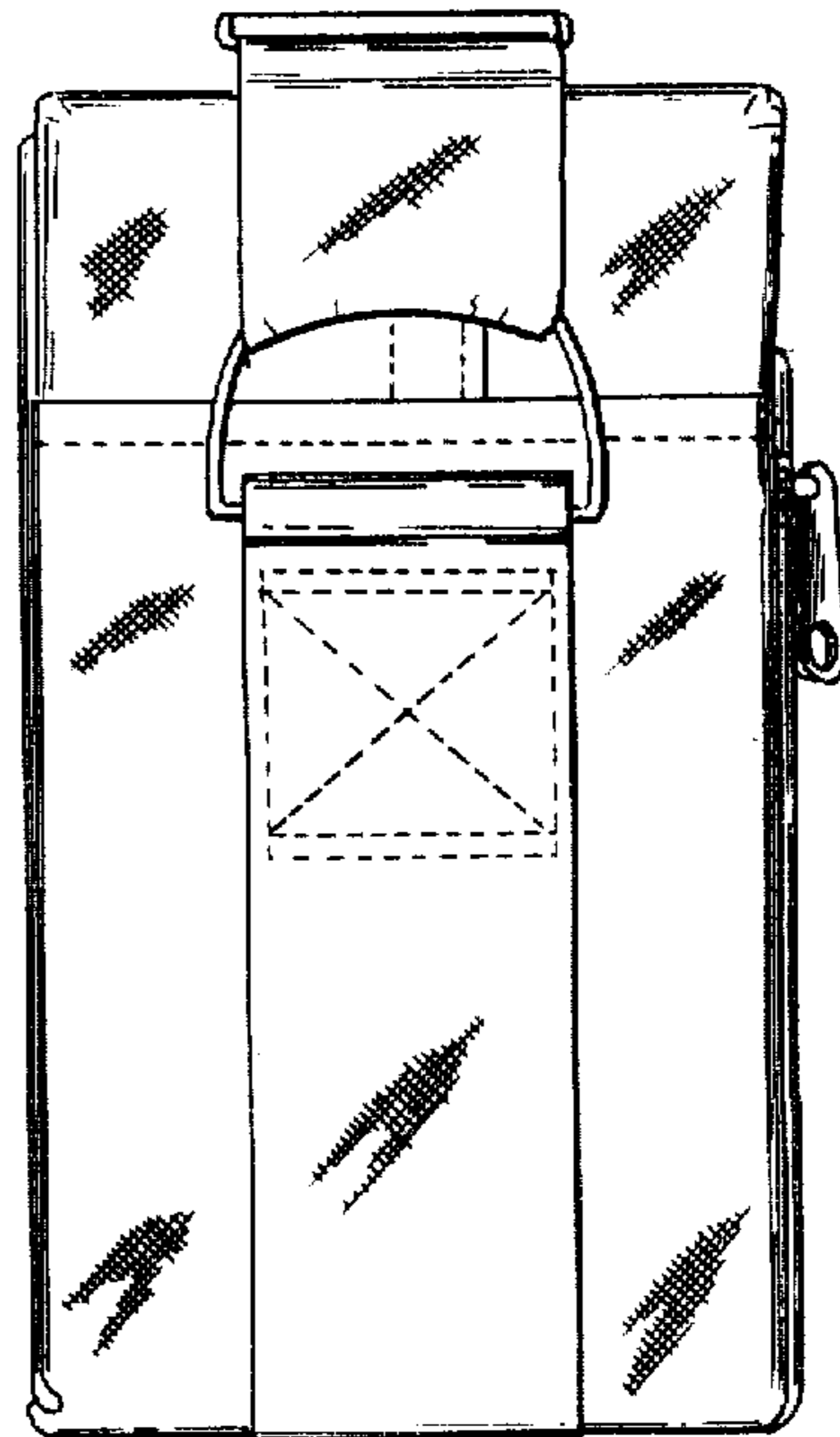

FIG. 6

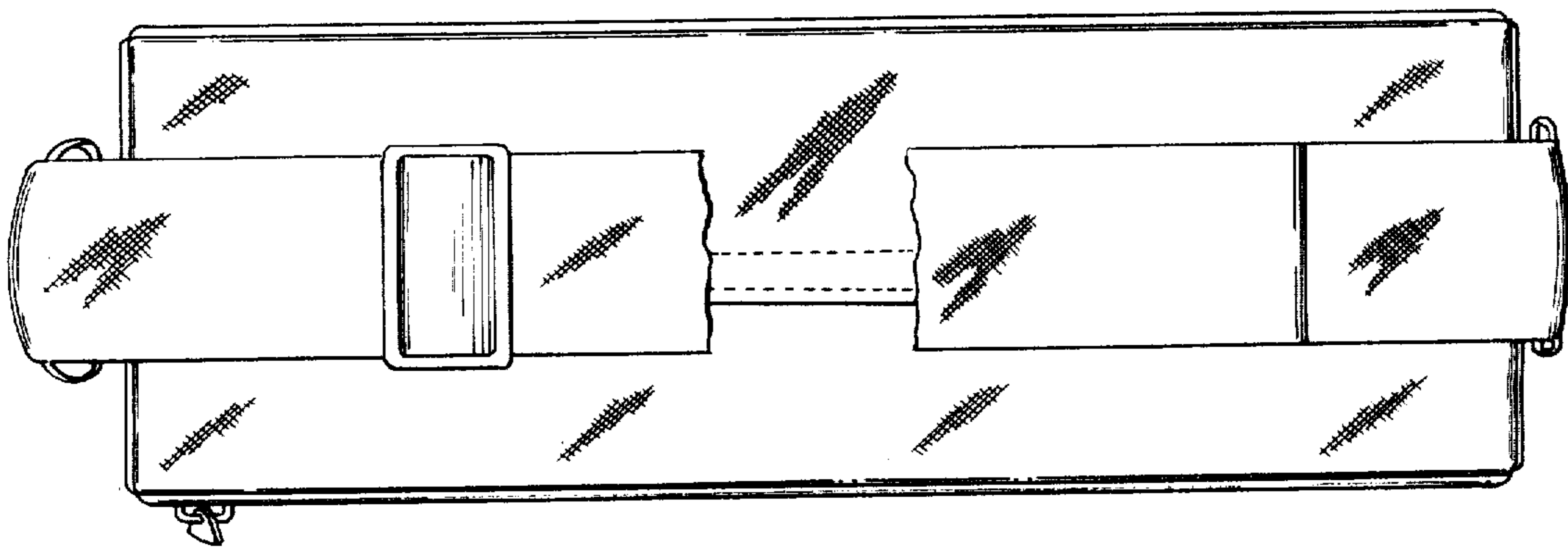

FIG. 7

