

- [54] PICTURE FRAME OR THE LIKE
- [75] Inventor: Robert H. C. M. Daenen, Hekelgem, Belgium
- [73] Assignee: Dart Industries Inc., Northbrook, Ill.
- [**] Term: 14 Years
- [21] Appl. No.: 231,189
- [22] Filed: Feb. 3, 1981
- [51] Int. Cl. D6-07
- [52] U.S. Cl. D6/235; D6/242; D6/244
- [58] Field of Search D6/232 F, 246; 40/152, 40/152.1, 152.2

3,715,824	2/1973	Rochman	40/152
4,096,656	6/1978	Diceglie	40/152.2
4,193,521	3/1980	Bounds	222/142.4

OTHER PUBLICATIONS

Gifts & Decorative Accessories, 1-1976, p. 228, Frame near top of page.

Primary Examiner—Charles A. Rademaker
Attorney, Agent, or Firm—Leigh B. Taylor

[57] CLAIM

The ornamental design for a picture frame or the like, substantially as shown.

DESCRIPTION

FIG. 1 is a front perspective view of a picture frame or the like showing my new design;
 FIG. 2 is a rear perspective view thereof;
 FIG. 3 is a front elevational view thereof;
 FIG. 4 is a side elevational view thereof;
 FIG. 5 is a rear elevational view thereof;
 FIG. 6 is an end elevational view thereof; and,
 FIG. 7 is a cross-sectional view thereof taken along line 7-7 of FIG. 2.

[56] References Cited
 U.S. PATENT DOCUMENTS

D. 227,970	7/1973	Davidoff	D6/244
D. 240,492	7/1976	Burin	D6/236
3,070,914	1/1963	Henderson et al.	40/156
3,557,480	1/1971	Ebner	40/152.1
3,688,897	9/1972	Judd	206/45.26

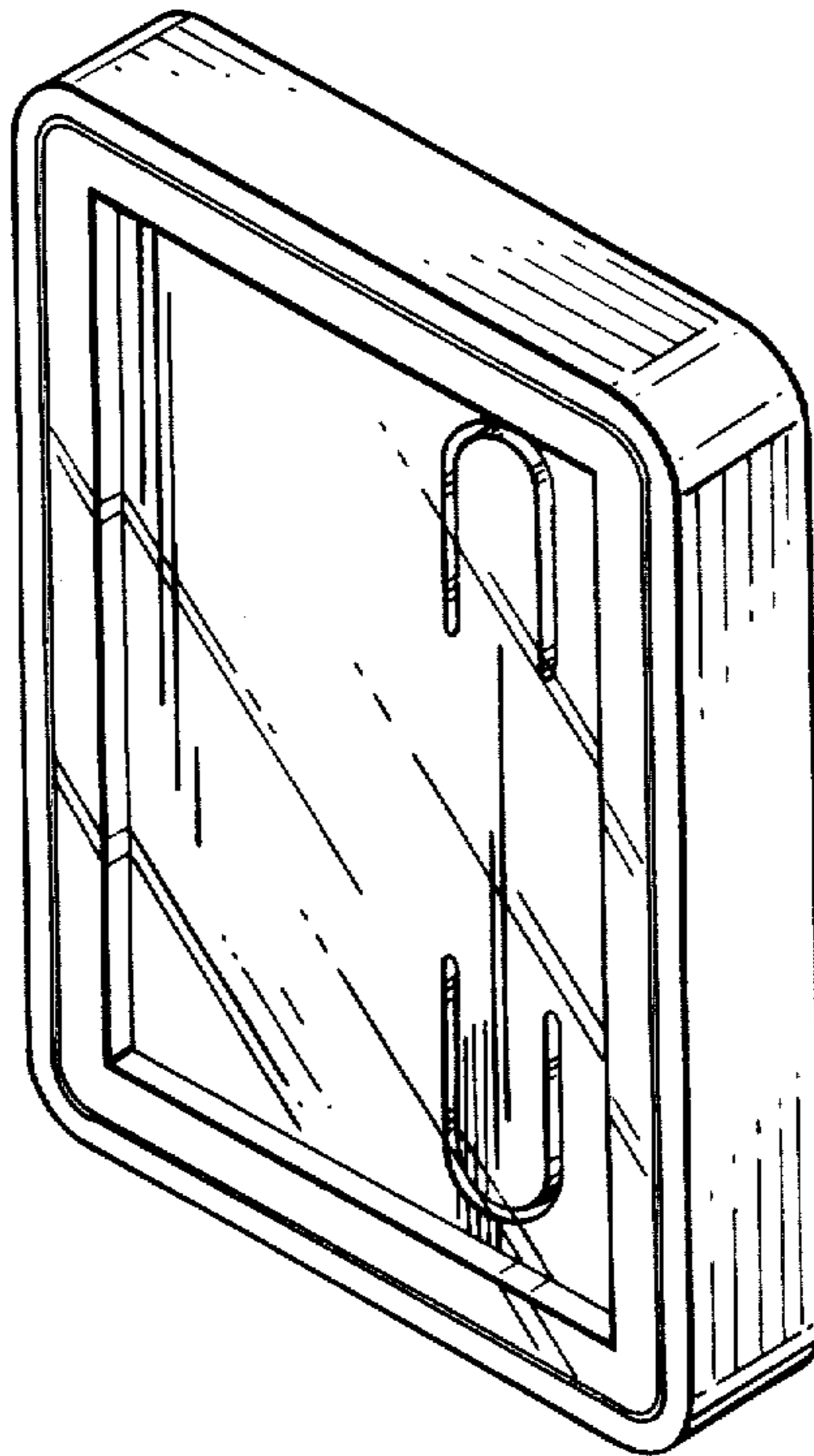

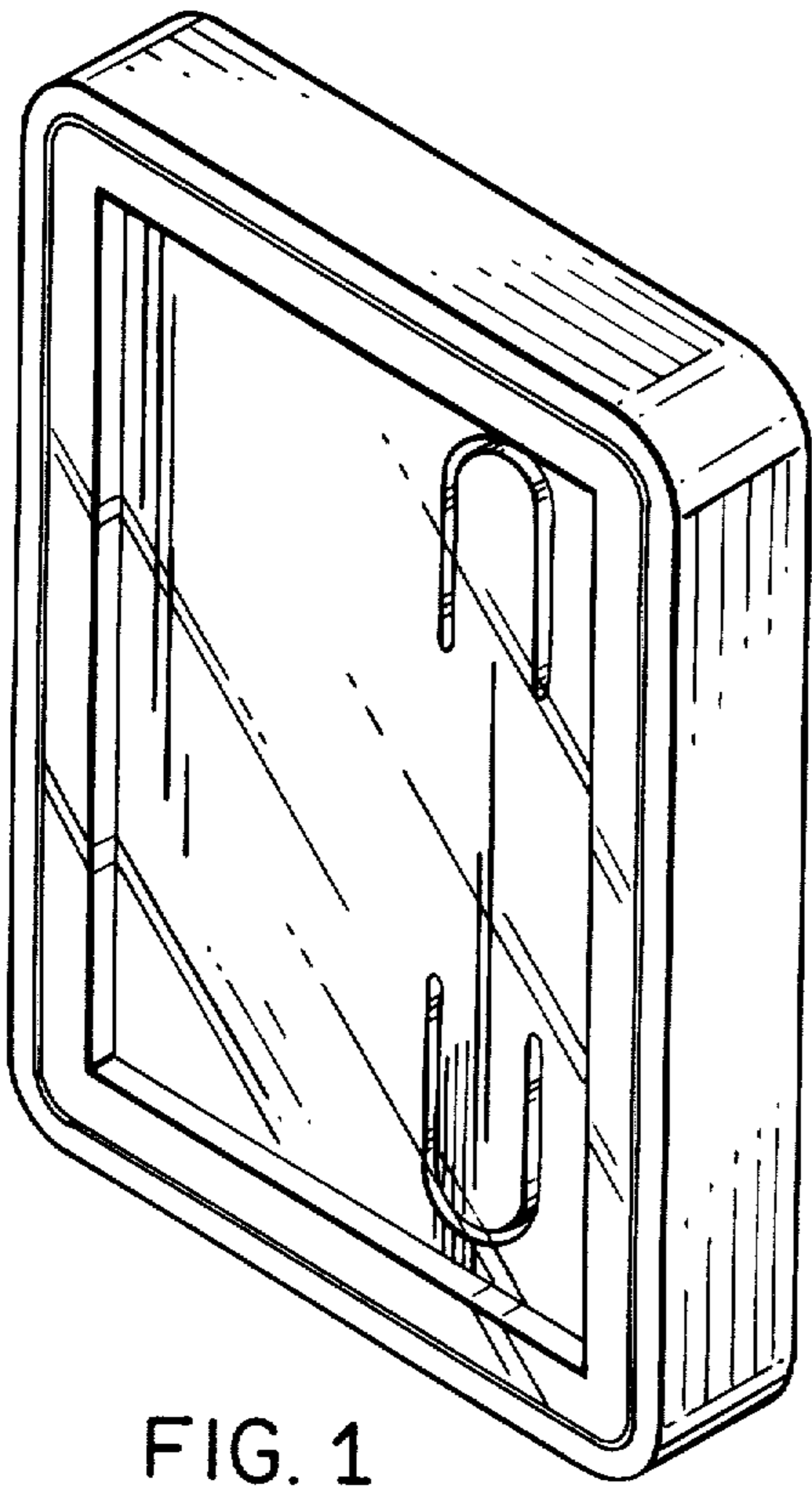

FIG. 1

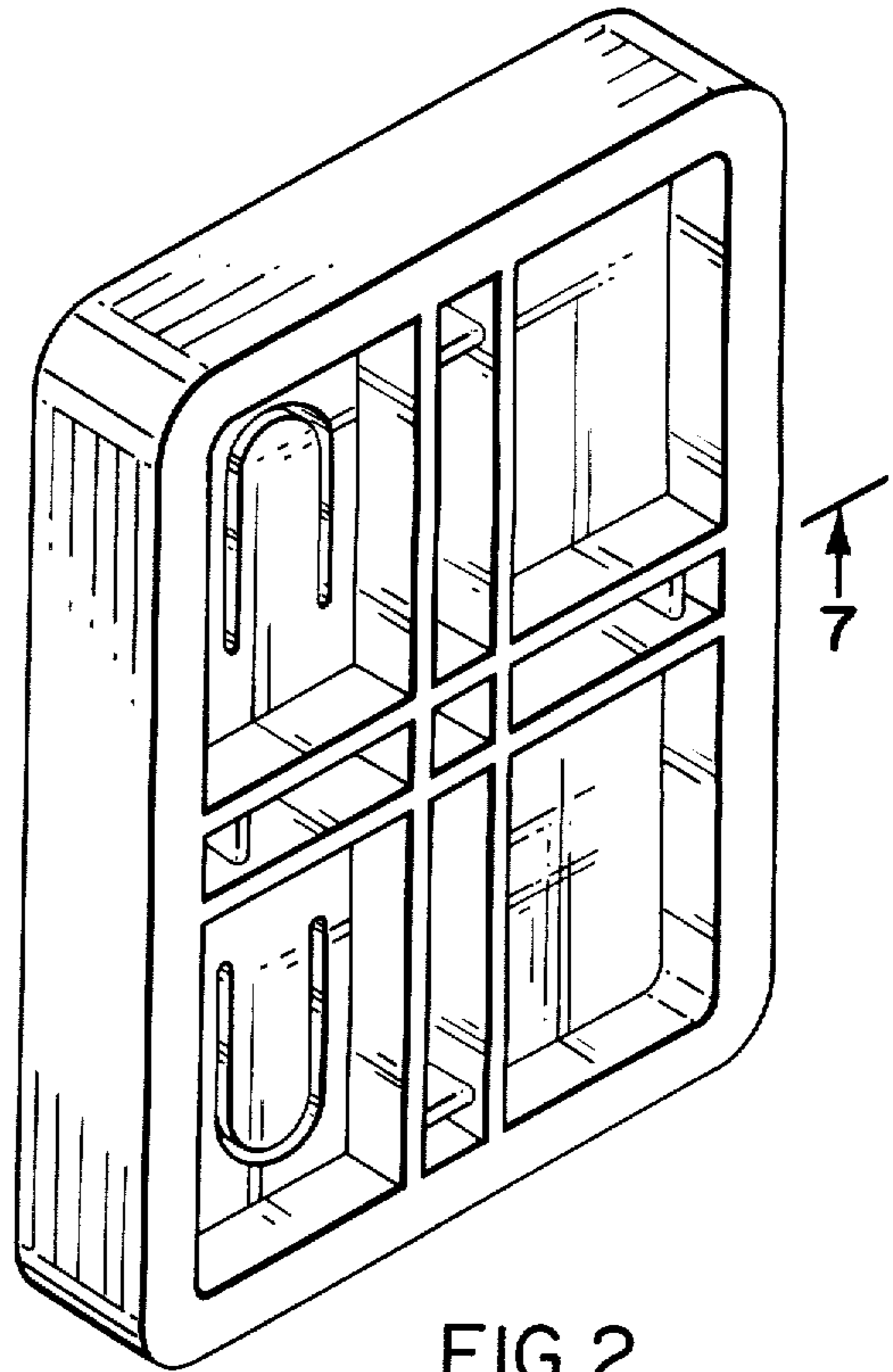

FIG. 2

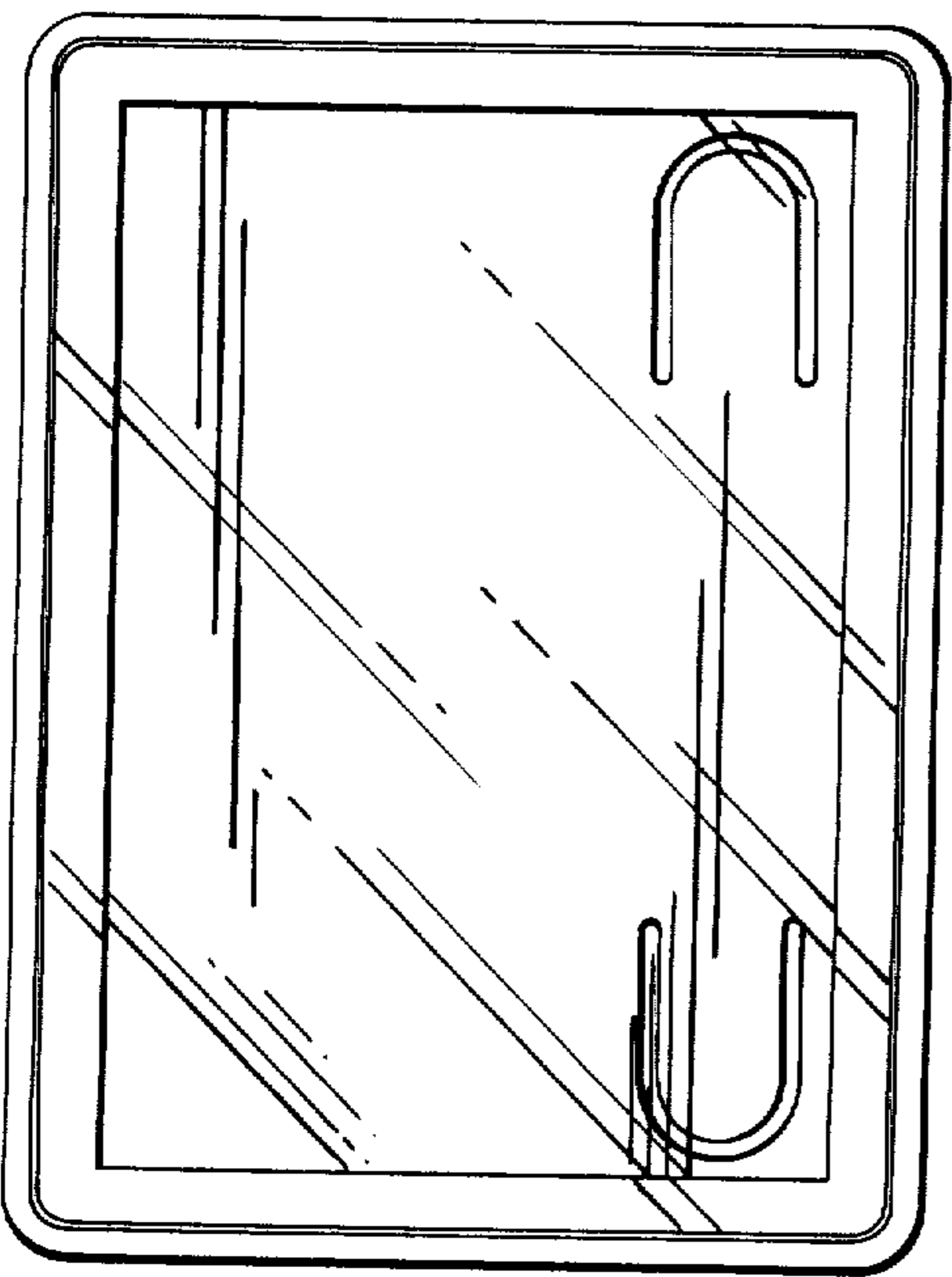

FIG. 3

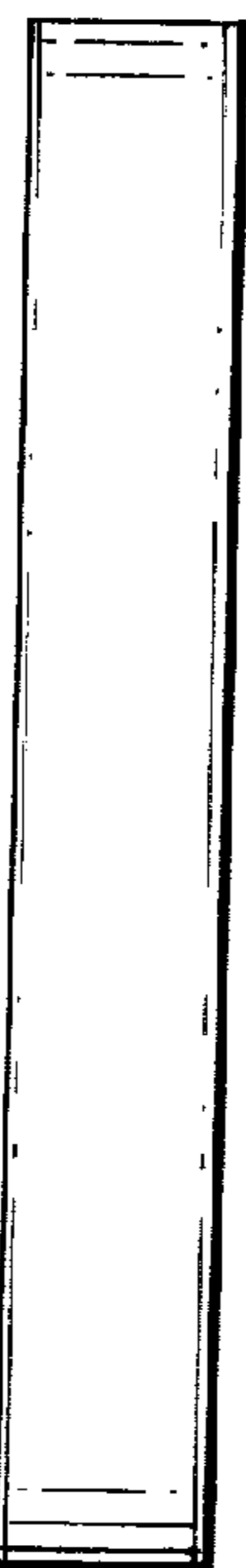

FIG. 4

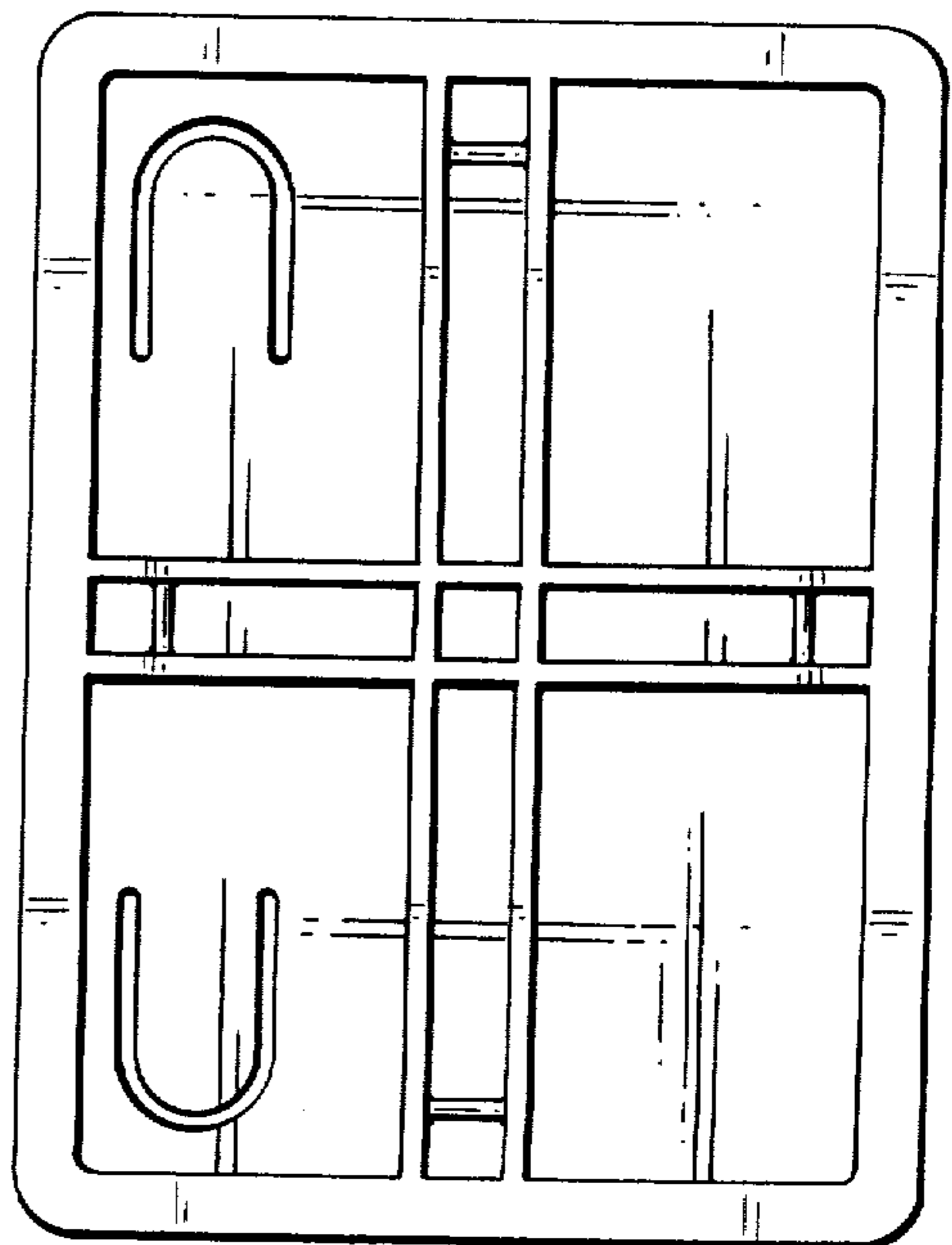

FIG. 5

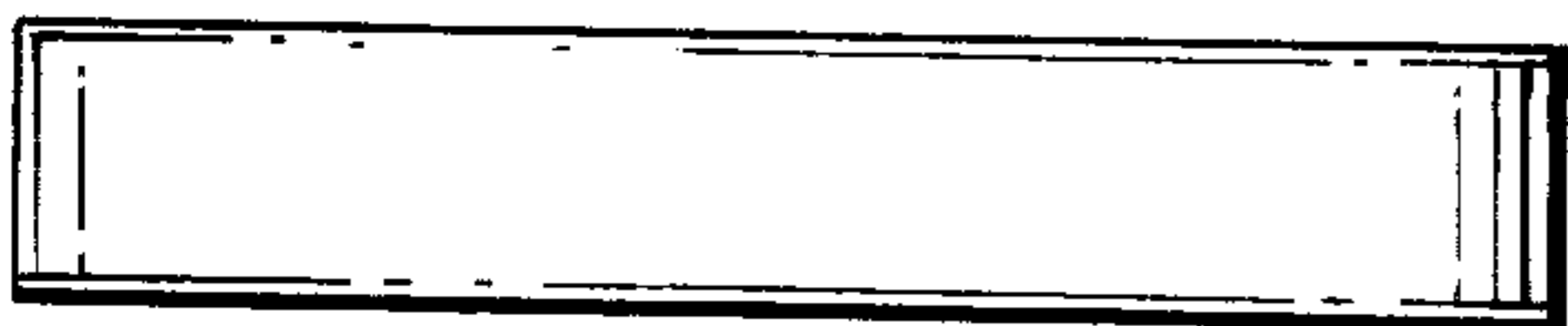

FIG. 6

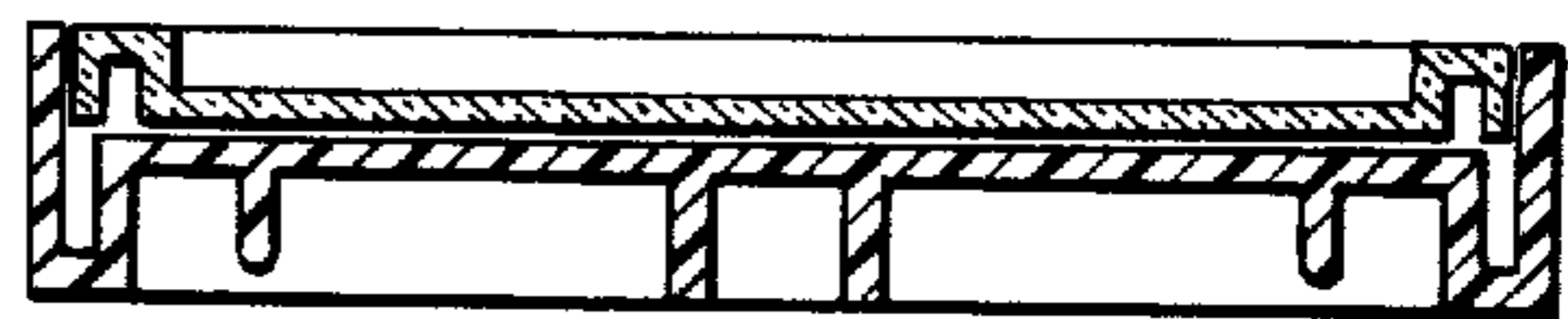

FIG. 7