

[54] COMBINATION CHAIR AND STEPSTOOL

[75] Inventors: Mel Appel, Nine Nottingham Rd., Livingston, N.J. 07039; George Kress, Scotch Plains, N.J.

[73] Assignee: Mel Appel, Livingston, N.J.

[**] Term: 14 Years

[21] Appl. No.: 184,223

[22] Filed: Sep. 4, 1980

[51] Int. Cl. D6-99

[52] U.S. Cl. D6/4; D6/32; D6/64

[58] Field of Search D6/20-36, D6/47-78

[56] References Cited

U.S. PATENT DOCUMENTS

D. 184,390	2/1959	Cramer	D6/32
D. 193,845	10/1962	Goldman et al.	D6/32
D. 197,842	3/1964	Keller et al.	D6/32
D. 212,086	8/1968	Gilman	D6/32
D. 244,494	5/1977	Dottinger	D6/32

Primary Examiner—Bruce W. Dunkins

Attorney, Agent, or Firm—Lerner, David, Littenberg & Samuel

[57] CLAIM

The design for a combination chair and stepstool, substantially as shown and described.

DESCRIPTION

FIG. 1 is a front elevational view of a combination chair and stepstool in the chair configuration showing our new design;

FIG. 2 is a left side elevational view in the chair configuration, the right side elevational view is a mirror image thereof;

FIG. 3 is a rear elevational view in the chair configuration;

FIG. 4 is a bottom plan view in the chair configuration;

FIG. 5 is a top plan view in the chair configuration;

FIG. 6 is a front elevational view of a combination chair and stepstool in the stepstool configuration;

FIG. 7 is a left side elevational view in the stepstool configuration, the right side elevational view is a mirror image thereof;

FIG. 8 is a rear elevational view in the stepstool configuration;

FIG. 9 is a top plan view in the stepstool configuration; and,

FIG. 10 is a bottom plan view in the stepstool configuration.

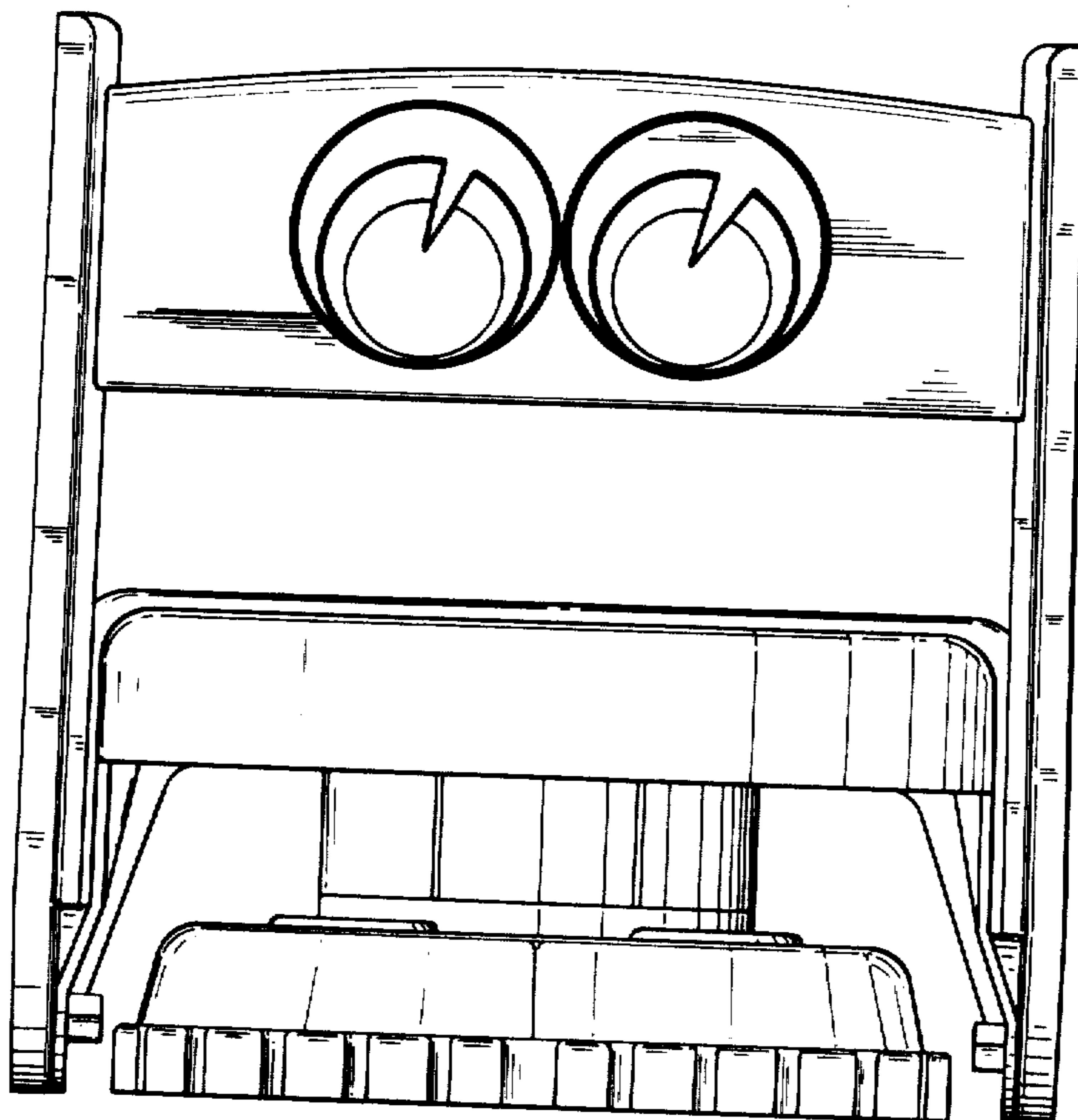

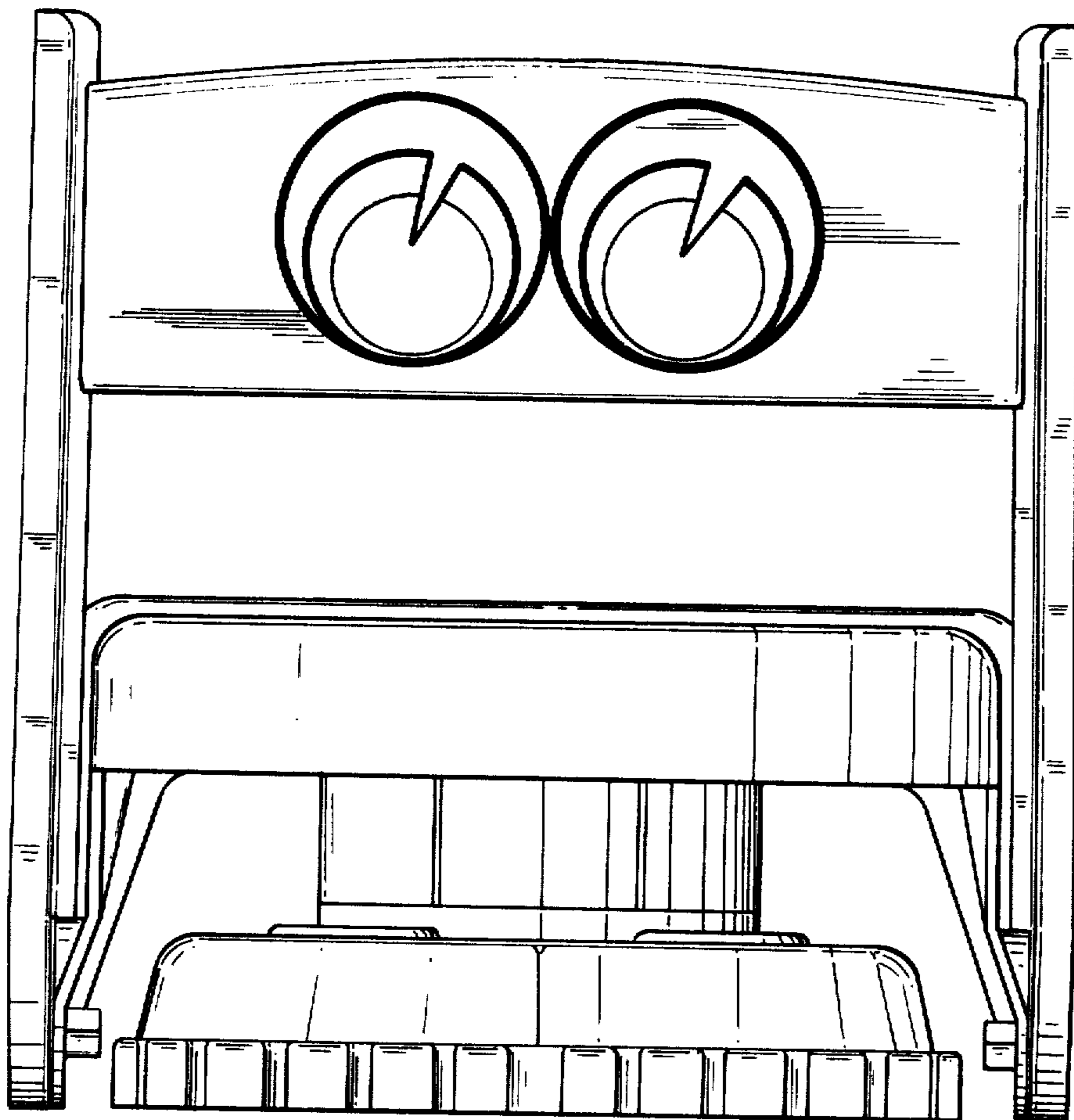

FIG.1

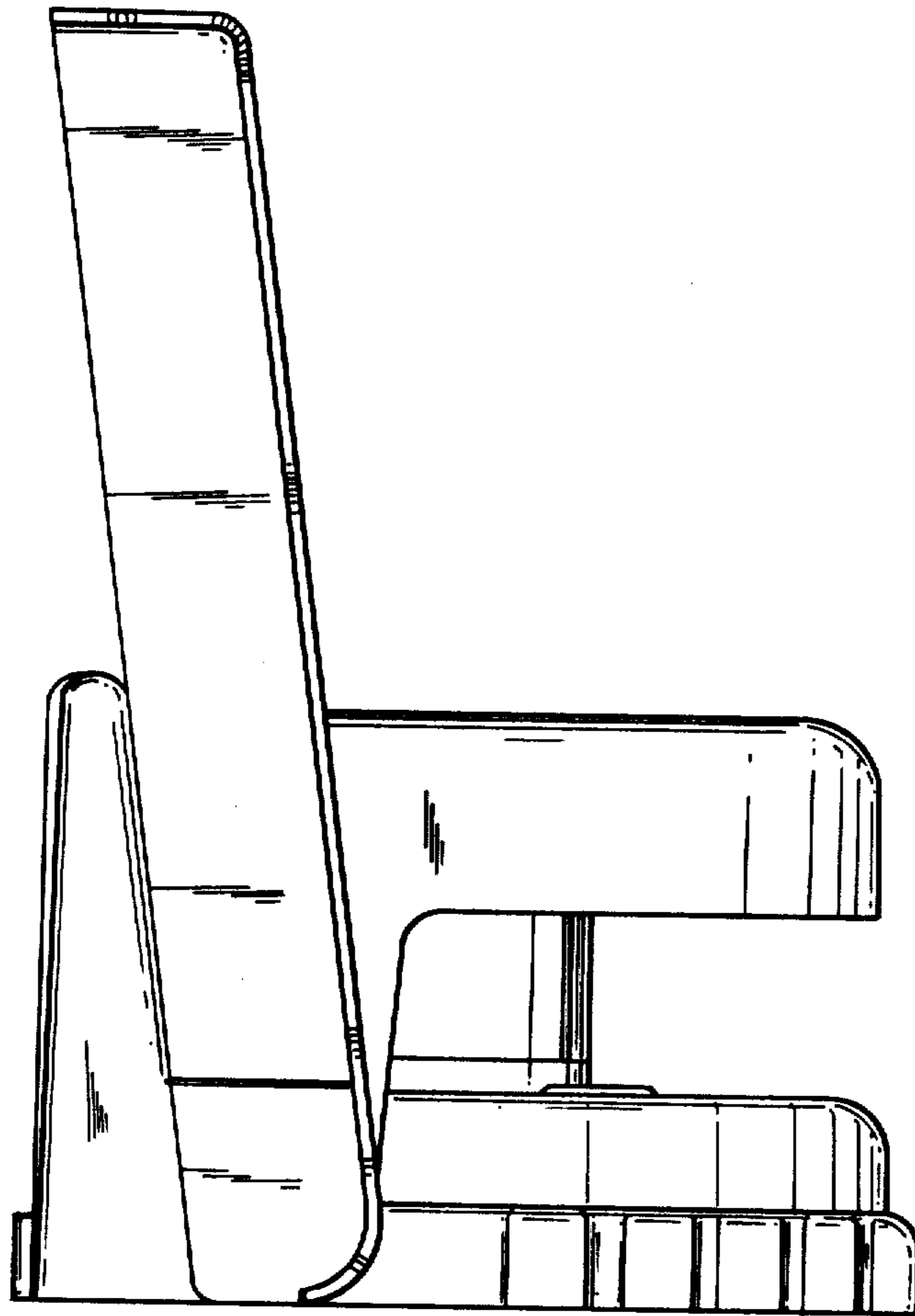

FIG. 2

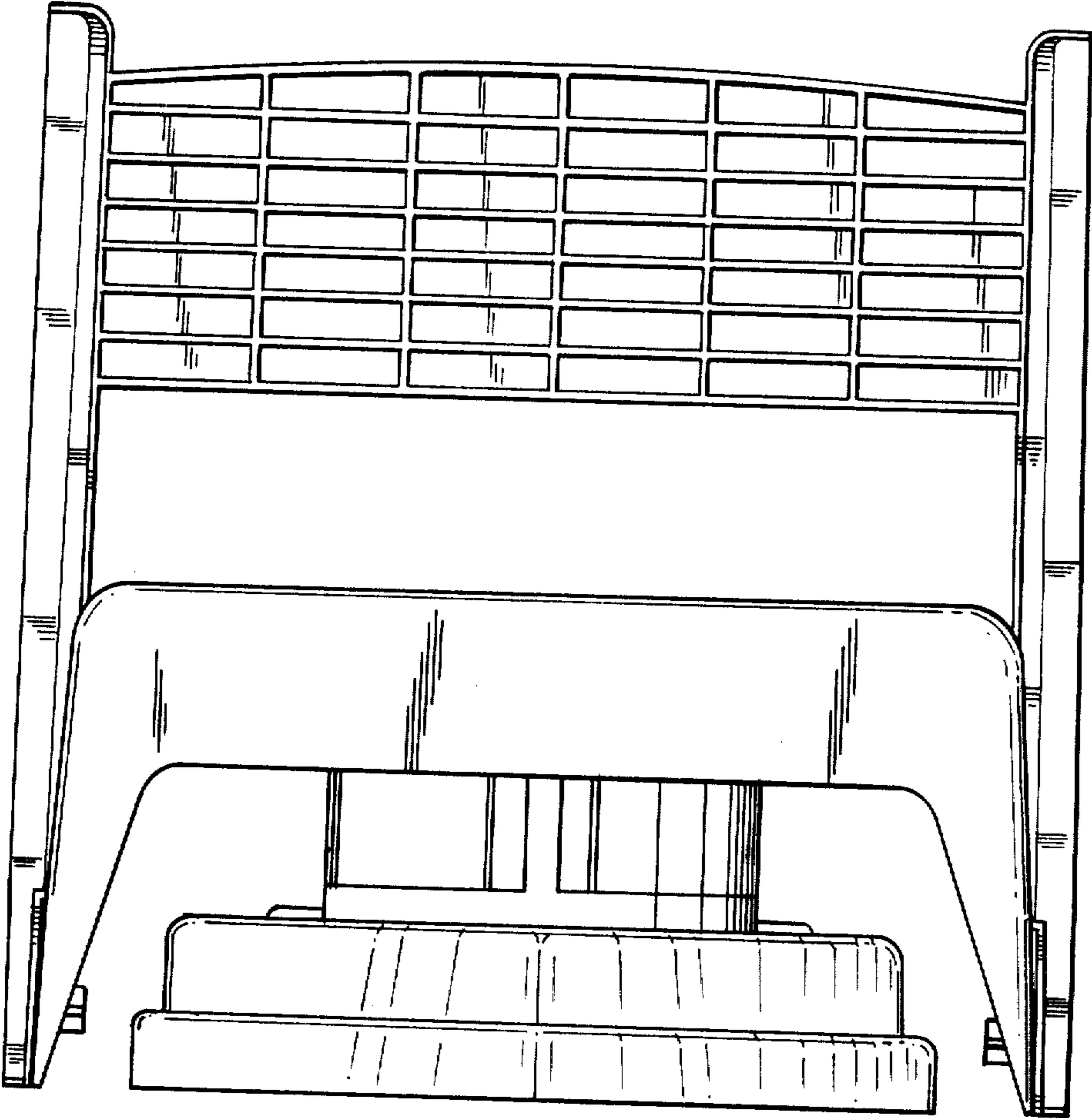

FIG. 3

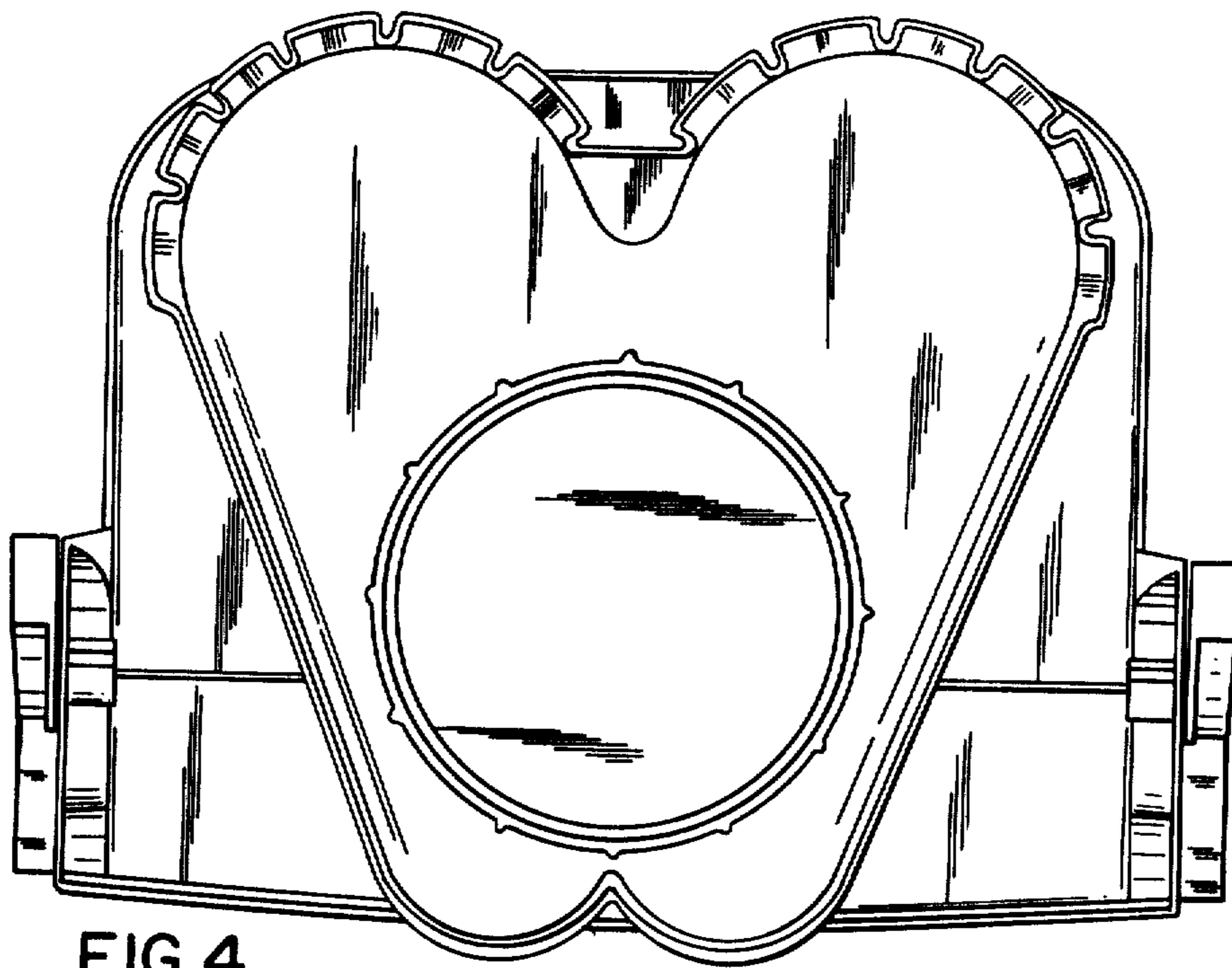

FIG. 4

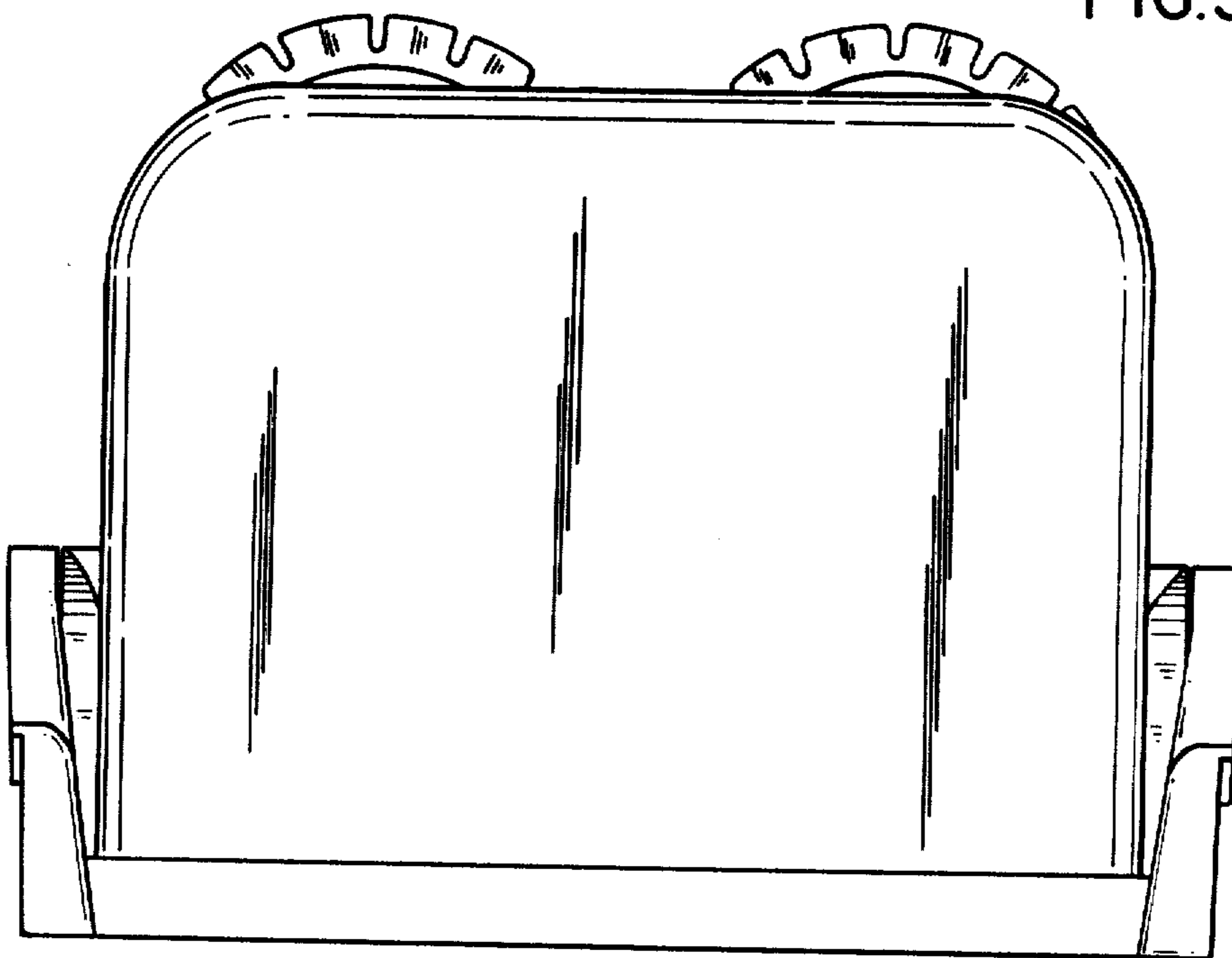

FIG. 5

FIG. 6

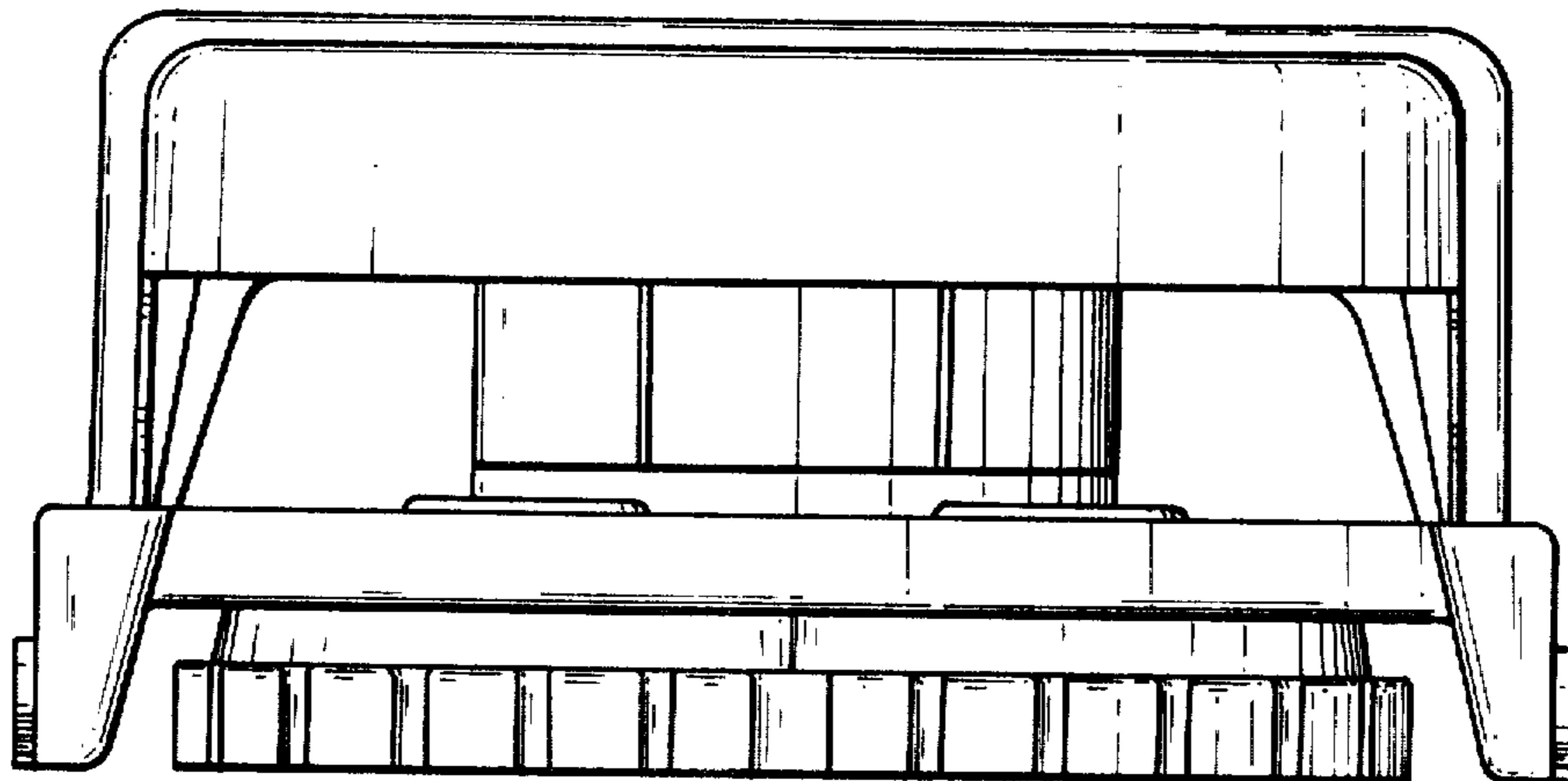

FIG. 7

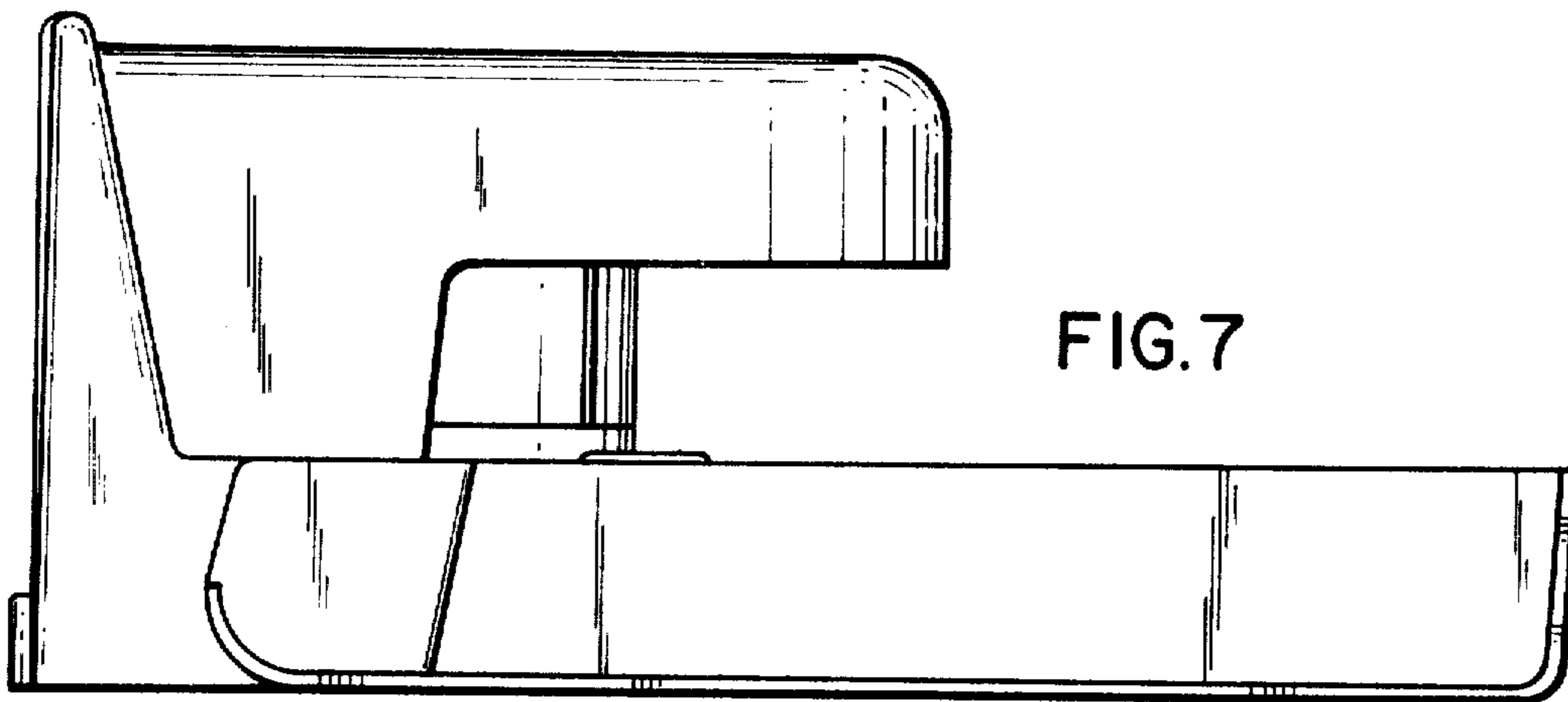
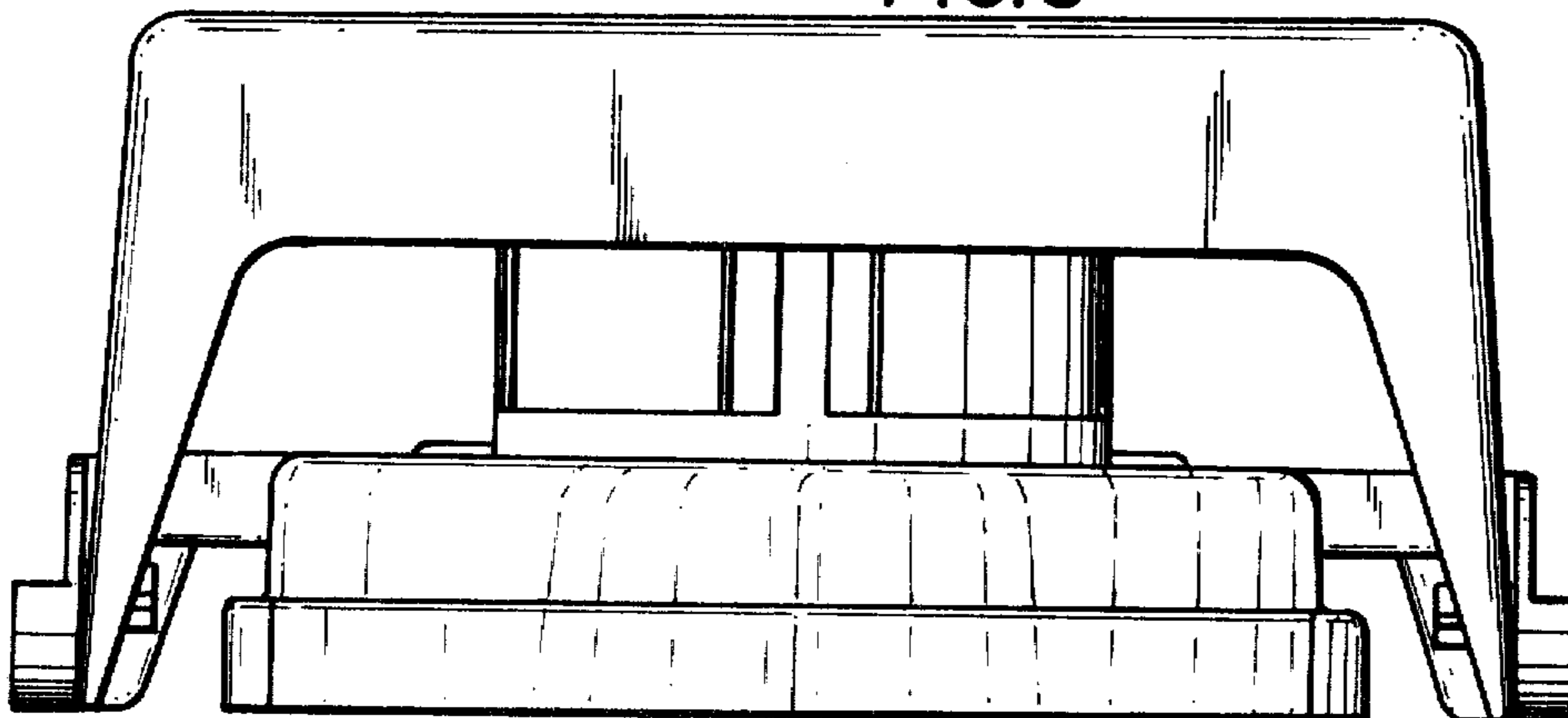

FIG. 8



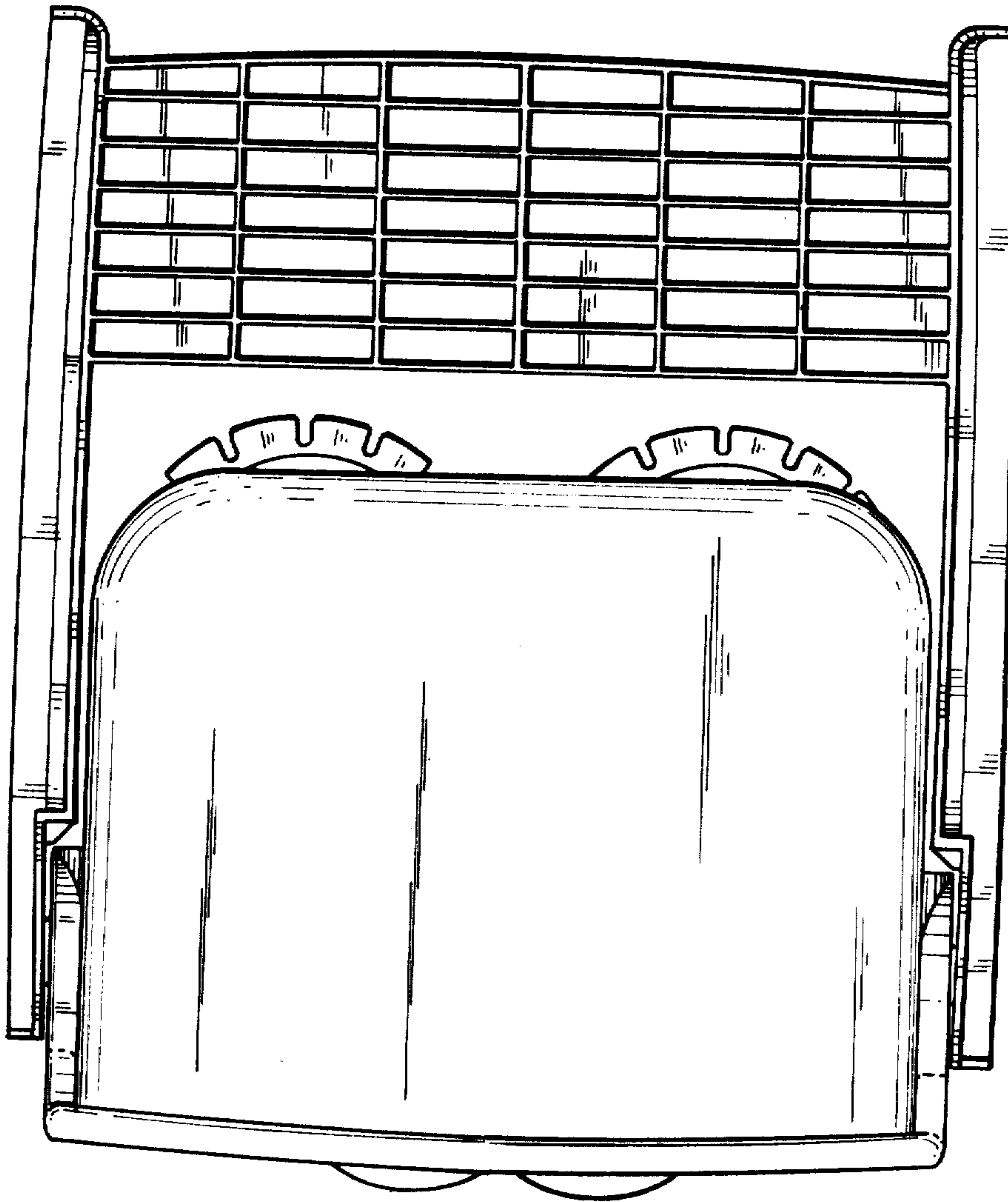

FIG. 9

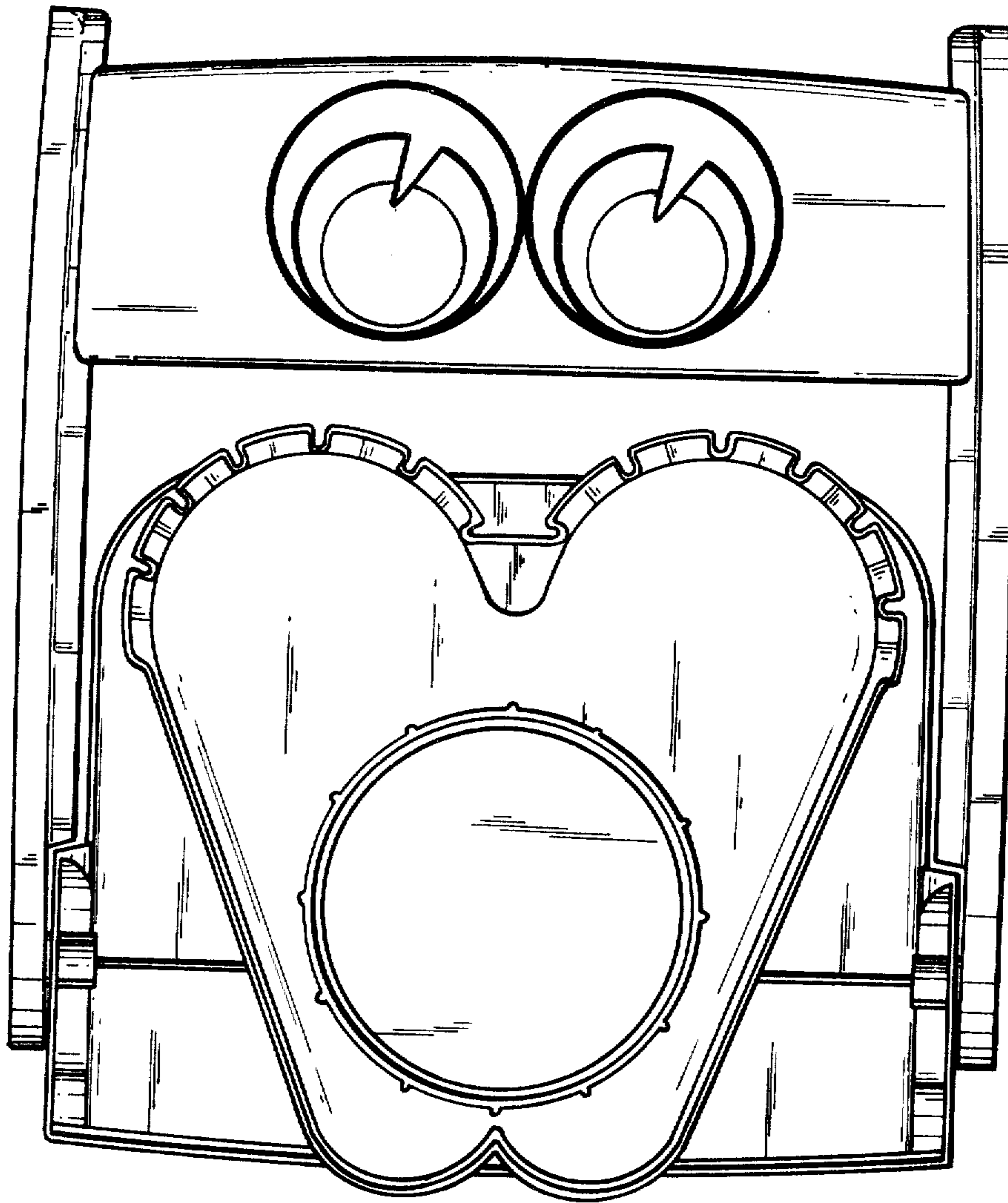

FIG.10