

[54] TOY XYLOPHONE

[75] Inventors: Mel Appel, Nine Nottingham Rd., Livingston, N.J. 07039; George Kress, Scotch Plains, N.J.

[73] Assignee: Mel Appel, Livingston, N.J.

[\*\*] Term: 14 Years

[21] Appl. No.: 235,149

[22] Filed: Feb. 17, 1981

[51] Int. Cl. .... D21-01

[52] U.S. Cl. .... D21/64; D21/158

[58] Field of Search ..... D21/64, 158, 59, 109, D21/148; 46/174, 175 R, 191, 117

[56] References Cited

U.S. PATENT DOCUMENTS

D. 83,529	3/1931	Fazekas	.....	D21/158
D. 208,415	8/1967	Musser	.....	D21/64
4,103,455	8/1978	Silvey	.....	46/175 R

OTHER PUBLICATIONS

Barry Toykraft Catalog, 1965, p. 9, item #109, "Pound-A-Tune".

Primary Examiner—Charles A. Rademaker  
Attorney, Agent, or Firm—Lerner, David, Littenberg & Samuel

[57] CLAIM

The ornamental design for a toy xylophone, substantially as shown and described.

DESCRIPTION

FIG. 1 is a perspective view of a toy xylophone showing our new design;  
FIG. 2 is a front elevational view thereof;  
FIG. 3 is a rear elevational view thereof;  
FIG. 4 is a left side elevational view thereof;  
FIG. 5 is a right side elevational view thereof;  
FIG. 6 is a top plan view thereof;  
FIG. 7 is a bottom plan view thereof.

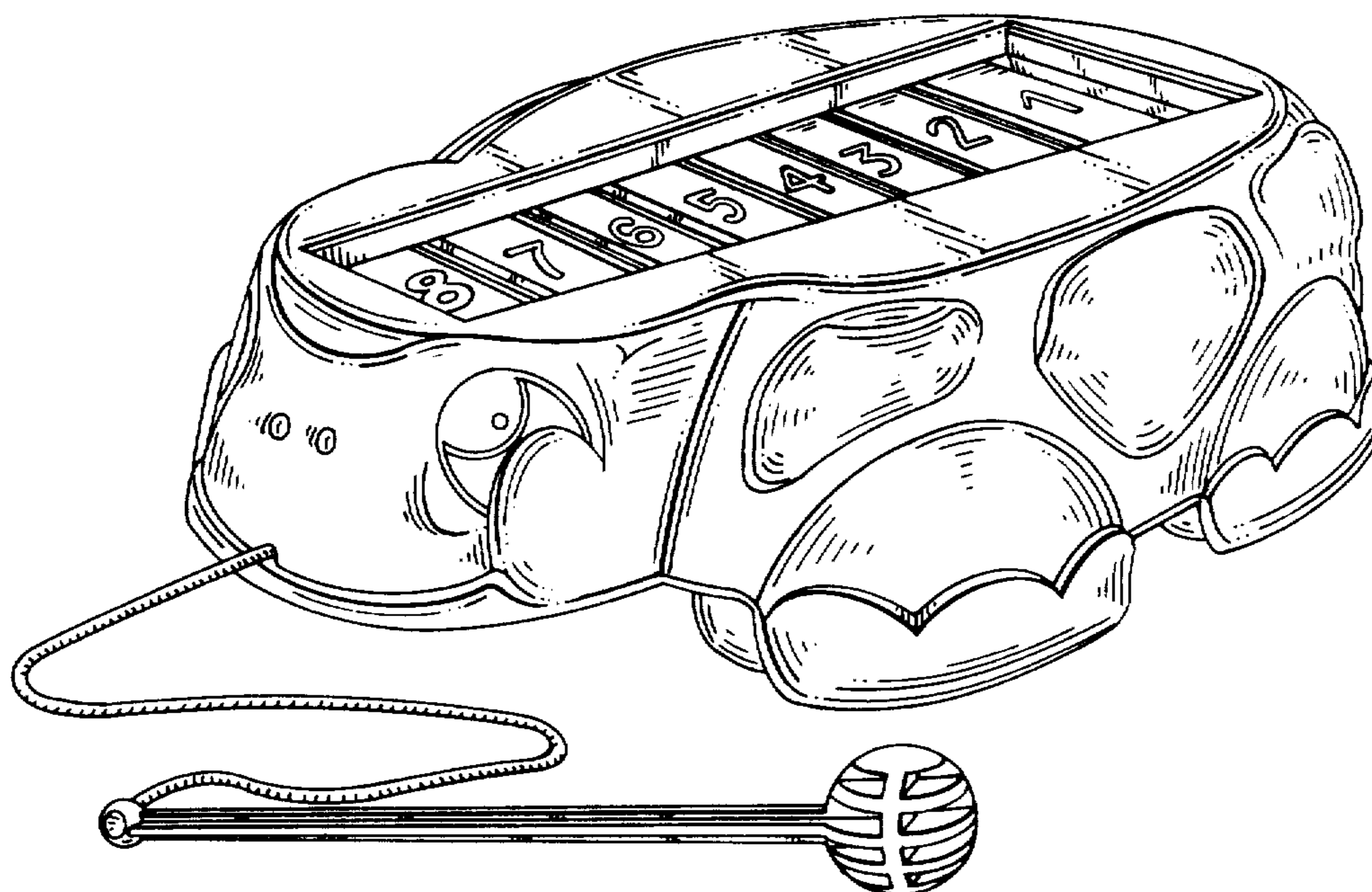

FIG. 1

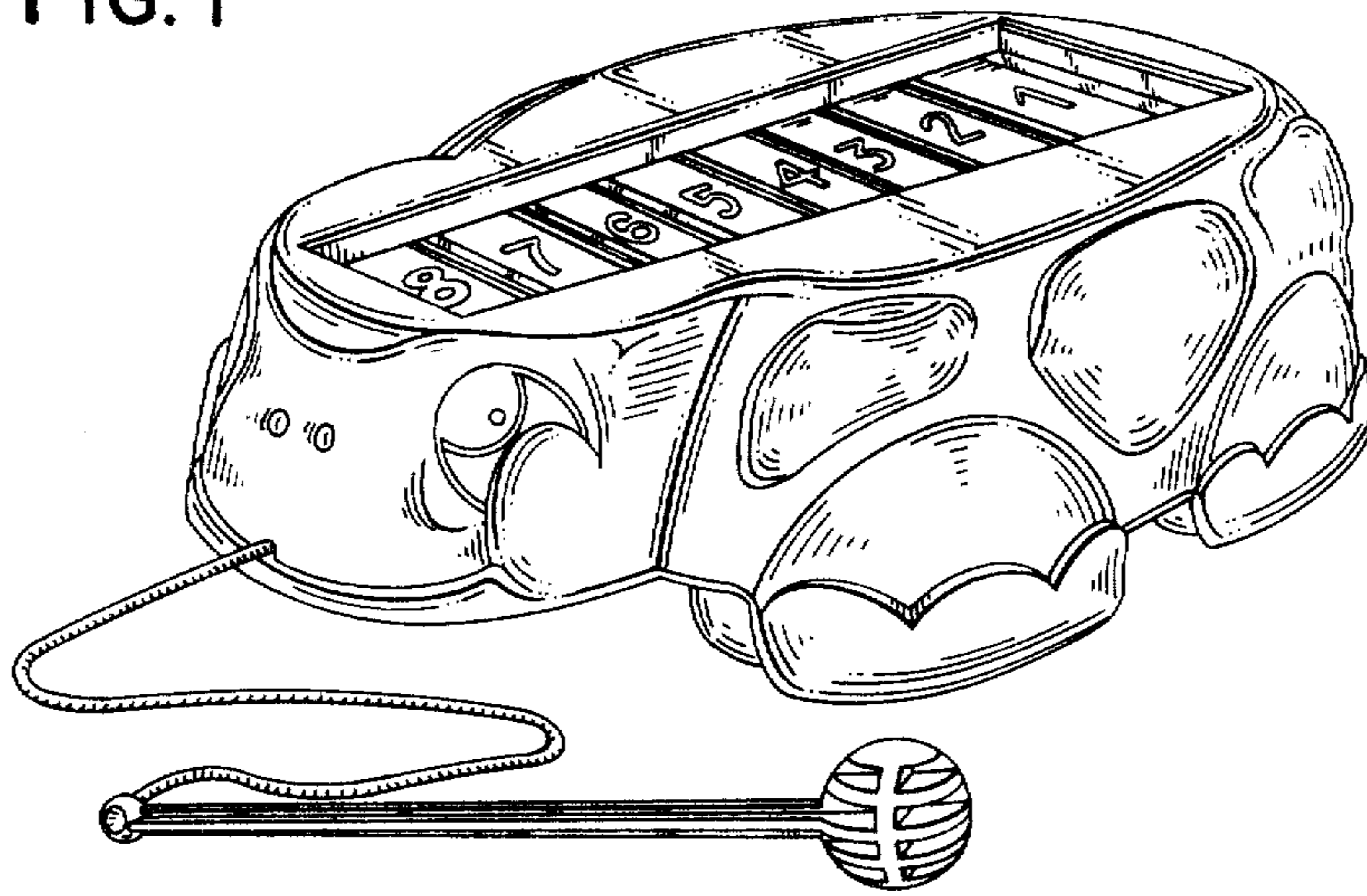

FIG. 2

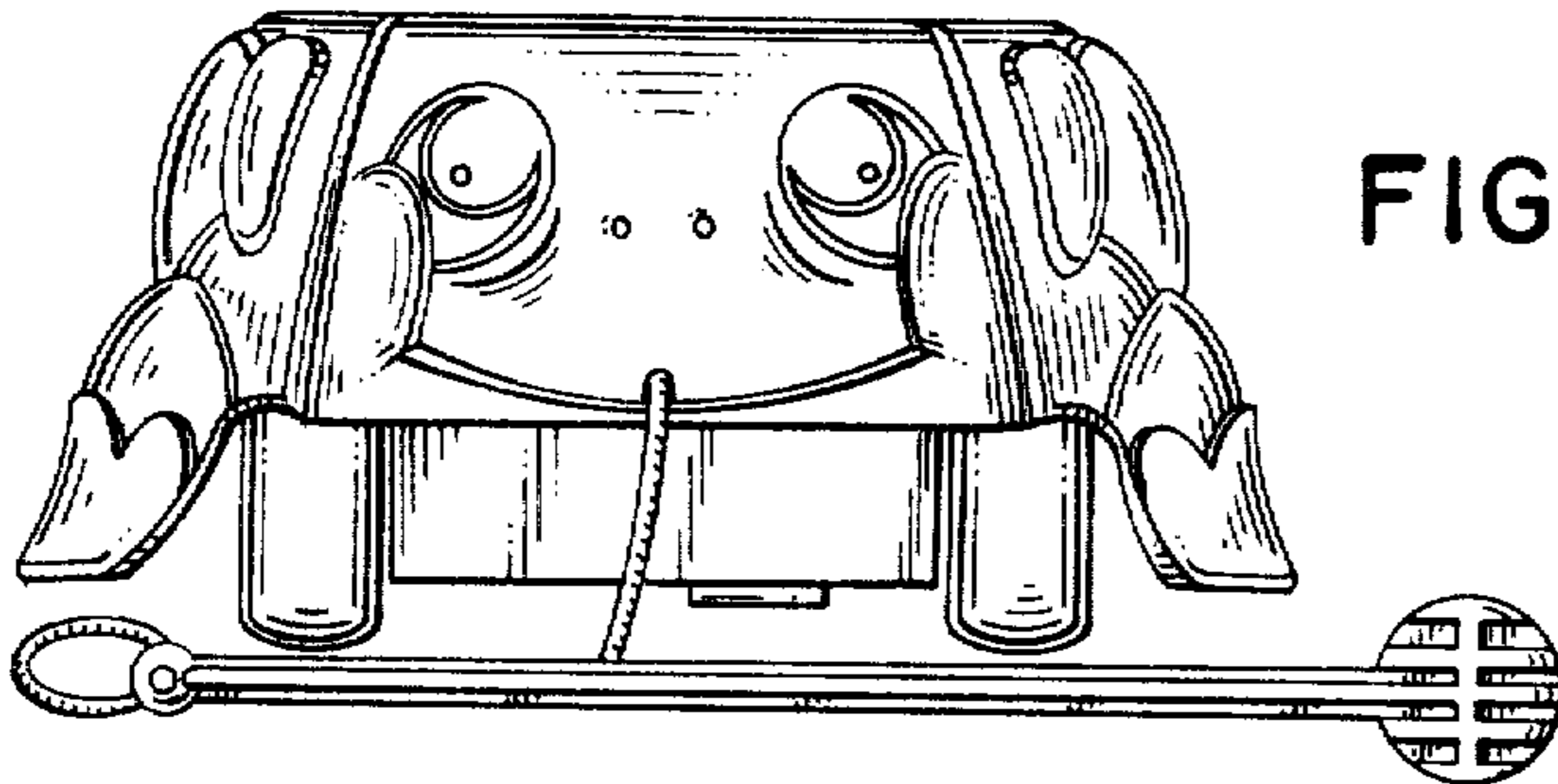

FIG. 4

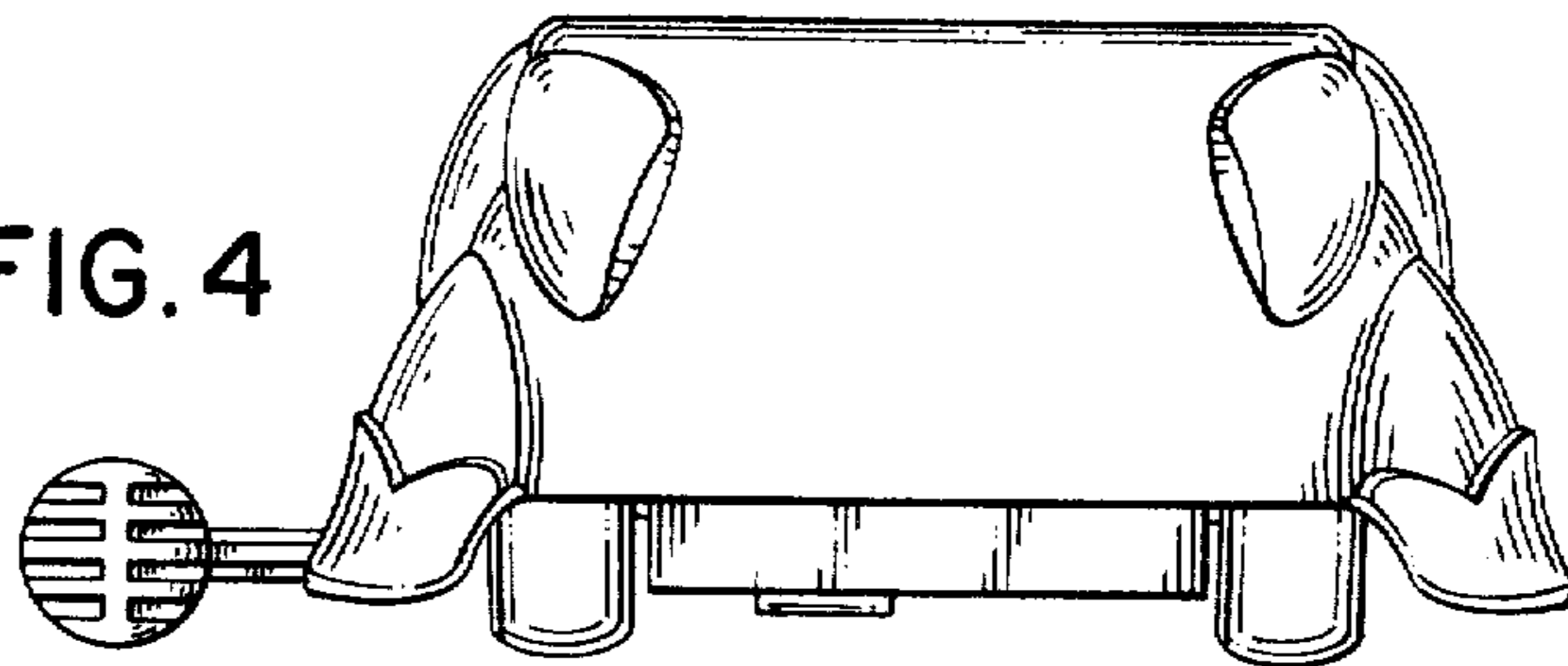

FIG. 3

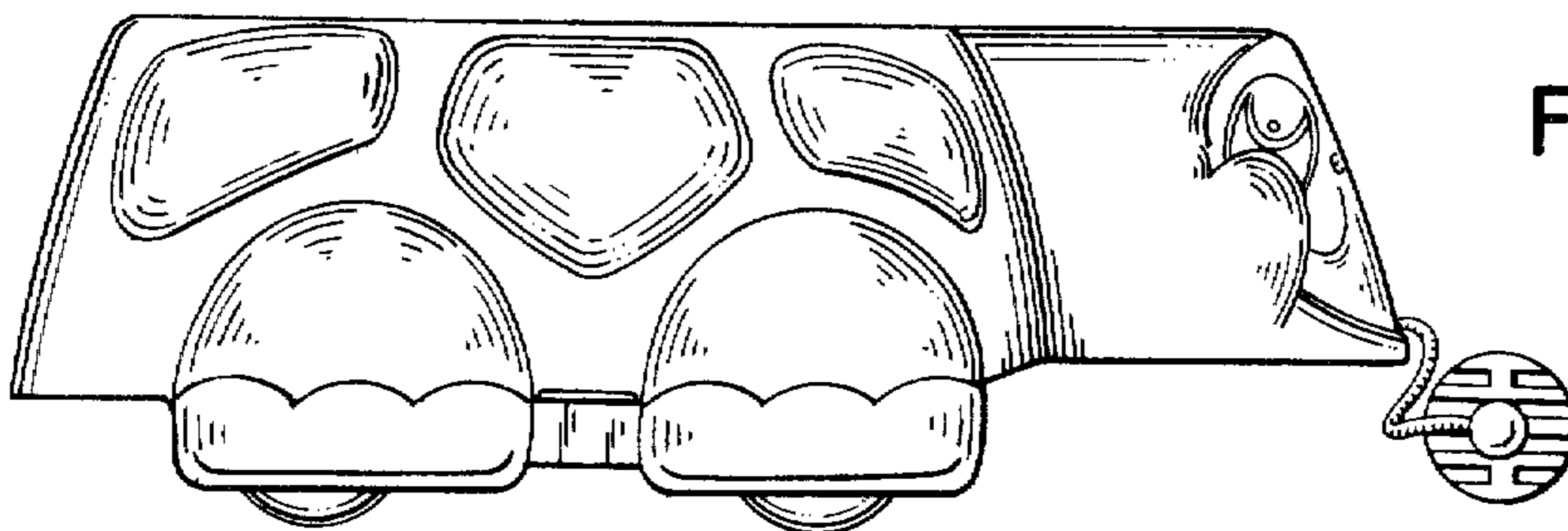

FIG.5

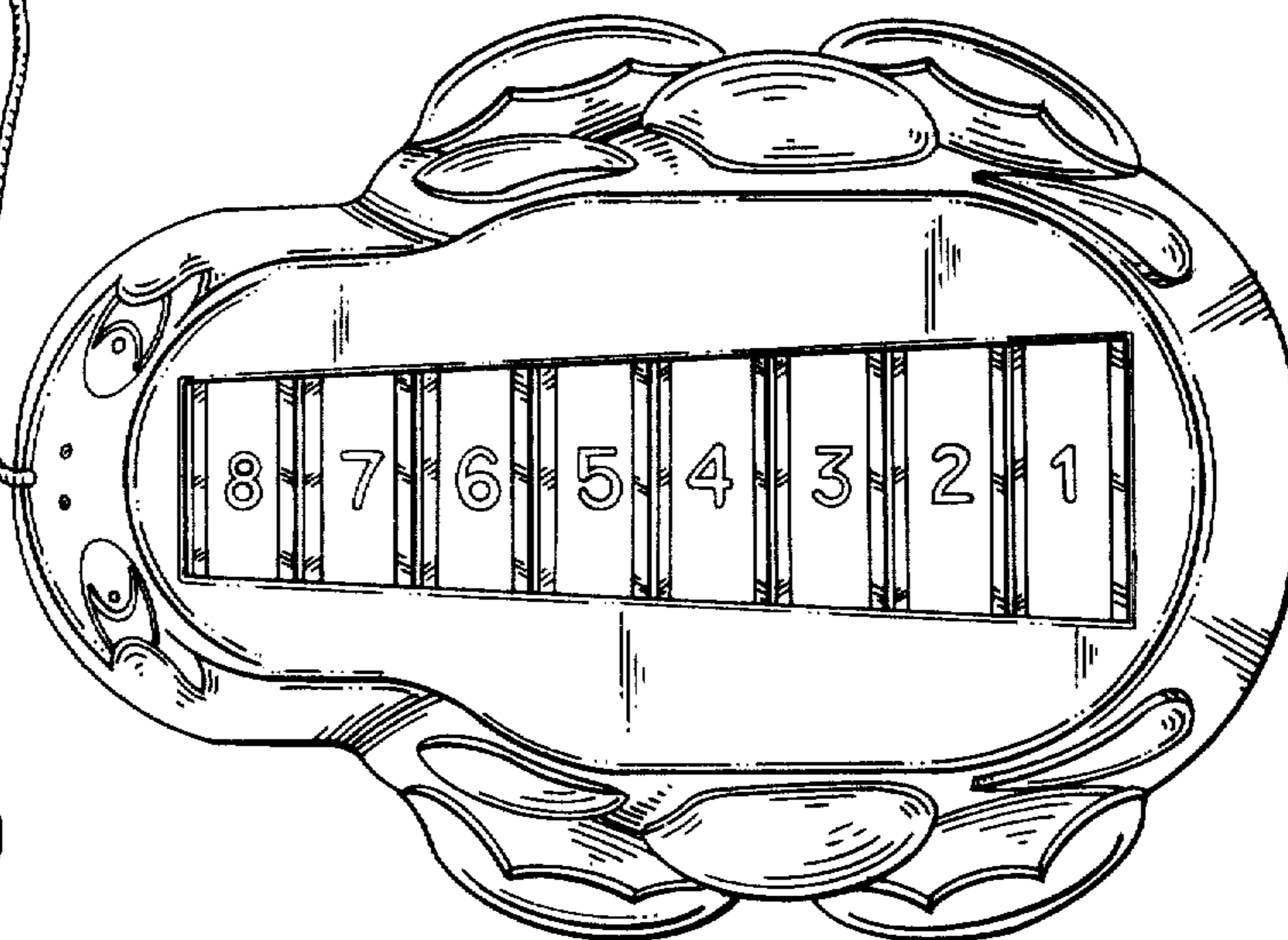
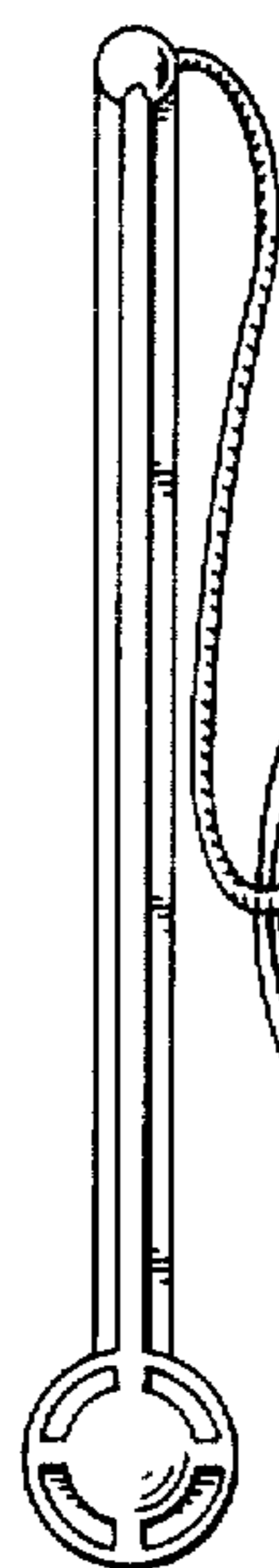
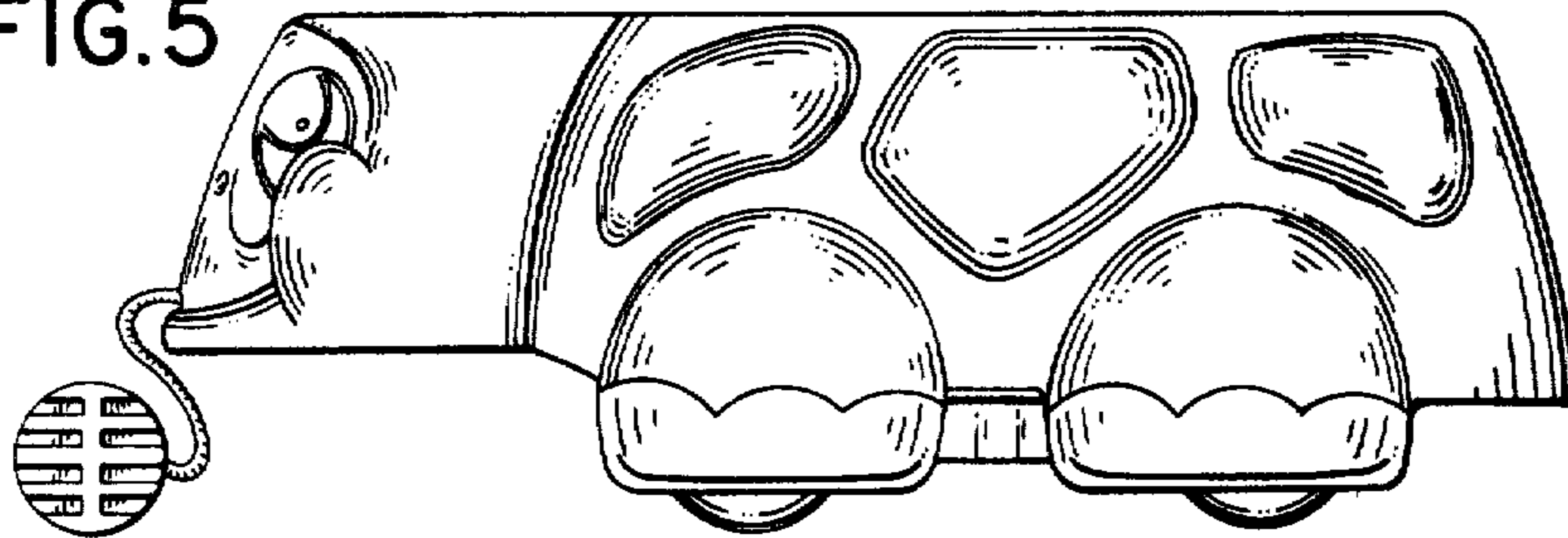

FIG.6

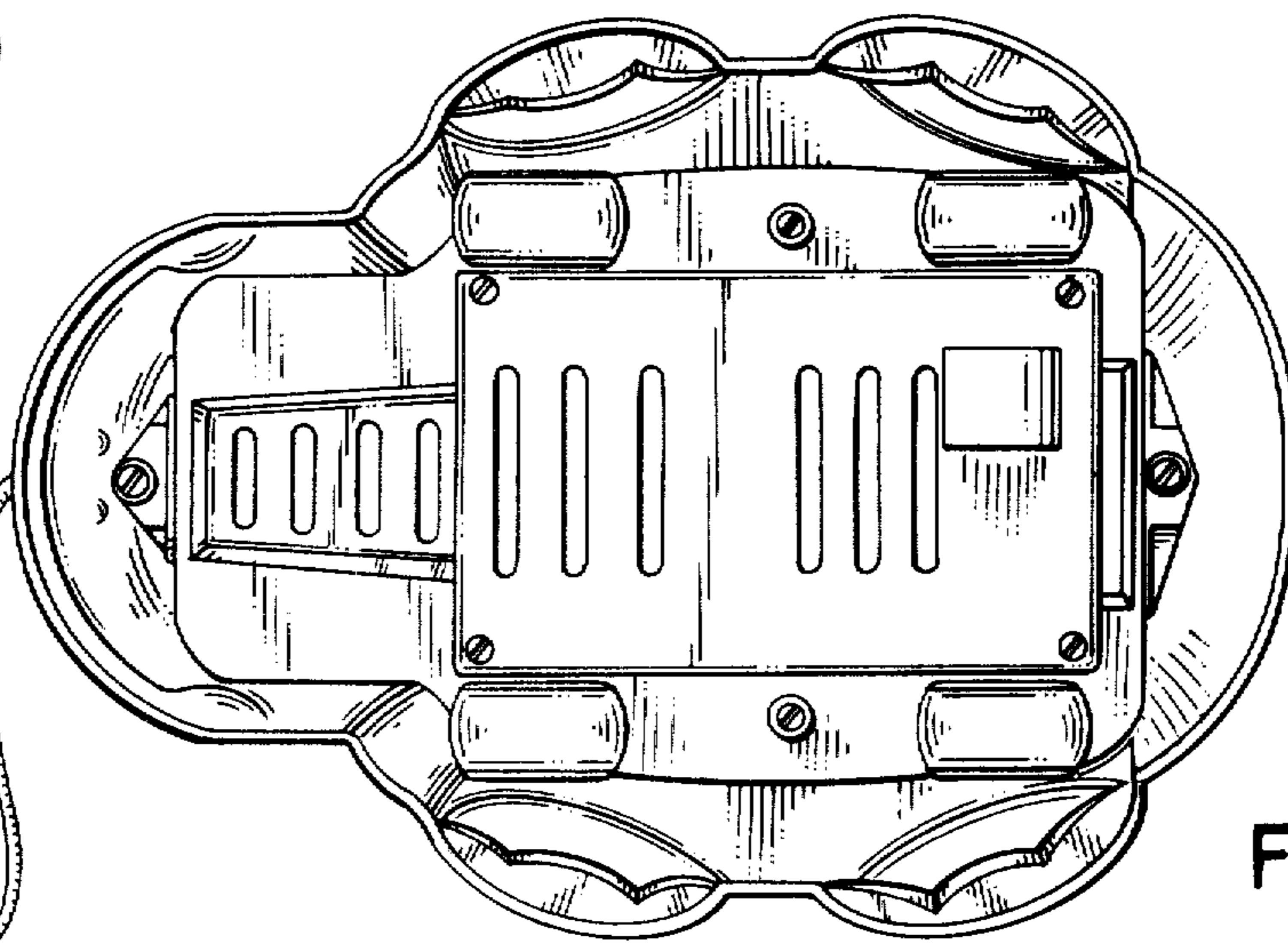
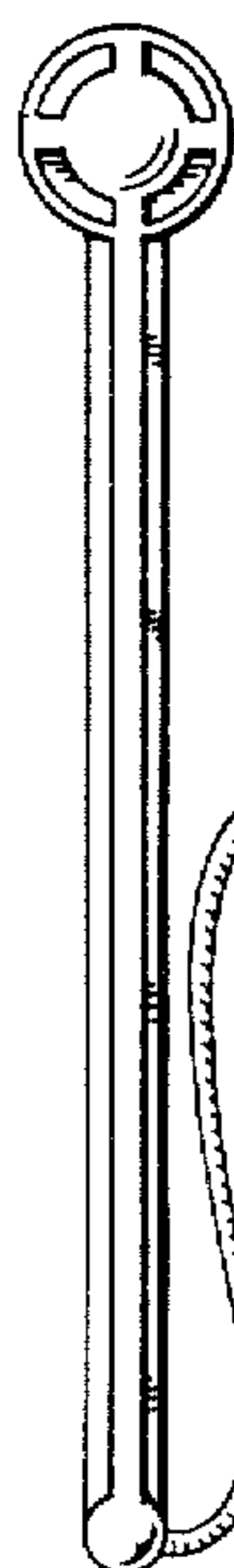

FIG.7