

[54] **DISPLAY TERMINAL OR SIMILAR ARTICLE**

[76] **Inventor:** Eric J. Marshall, 5 Carlton Gardens, London SW1, England

[\*\*] **Term:** 14 Years

[21] **Appl. No.:** 124,648

[22] **Filed:** Feb. 25, 1980

[30] **Foreign Application Priority Data**

Aug. 28, 1979 [GB] United Kingdom ..... 991322

[51] **Int. Cl.** ..... D14-02

[52] **U.S. Cl.** ..... D14/113

[58] **Field of Search** ..... D14/100-111, D14/113, 114, 115; 364/900; 340/700, 711, 720, 365 R

[56] **References Cited**

**U.S. PATENT DOCUMENTS**

D. 247,563 3/1978 Jinbo et al. .... D14/106

*Primary Examiner*—Susan J. Lucas

*Attorney, Agent, or Firm*—Schwartz & Weinrieb

[57] **CLAIM**

The ornamental design for a display terminal or similar article, as shown and described.

**DESCRIPTION**

FIG. 1 is a perspective view of a machine showing my new design;

FIG. 2 is a plan view thereof on an enlarged scale;

FIG. 3 is a front view thereof on an enlarged scale;

FIG. 4 is a side view thereof on an enlarged scale;

FIG. 5 is a rear view thereof on an enlarged scale; and

FIG. 6 is a bottom view thereof on an enlarged scale.

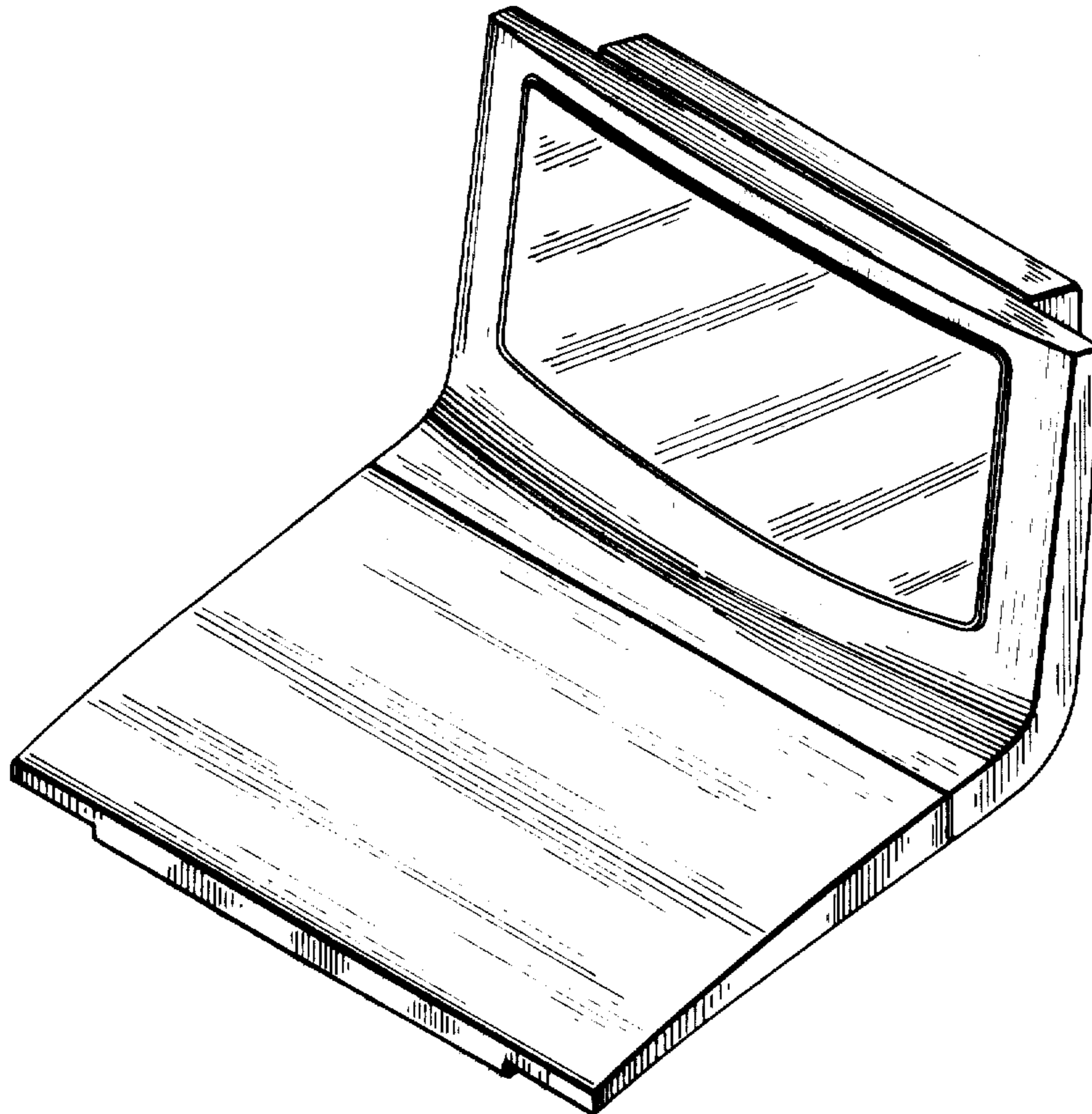

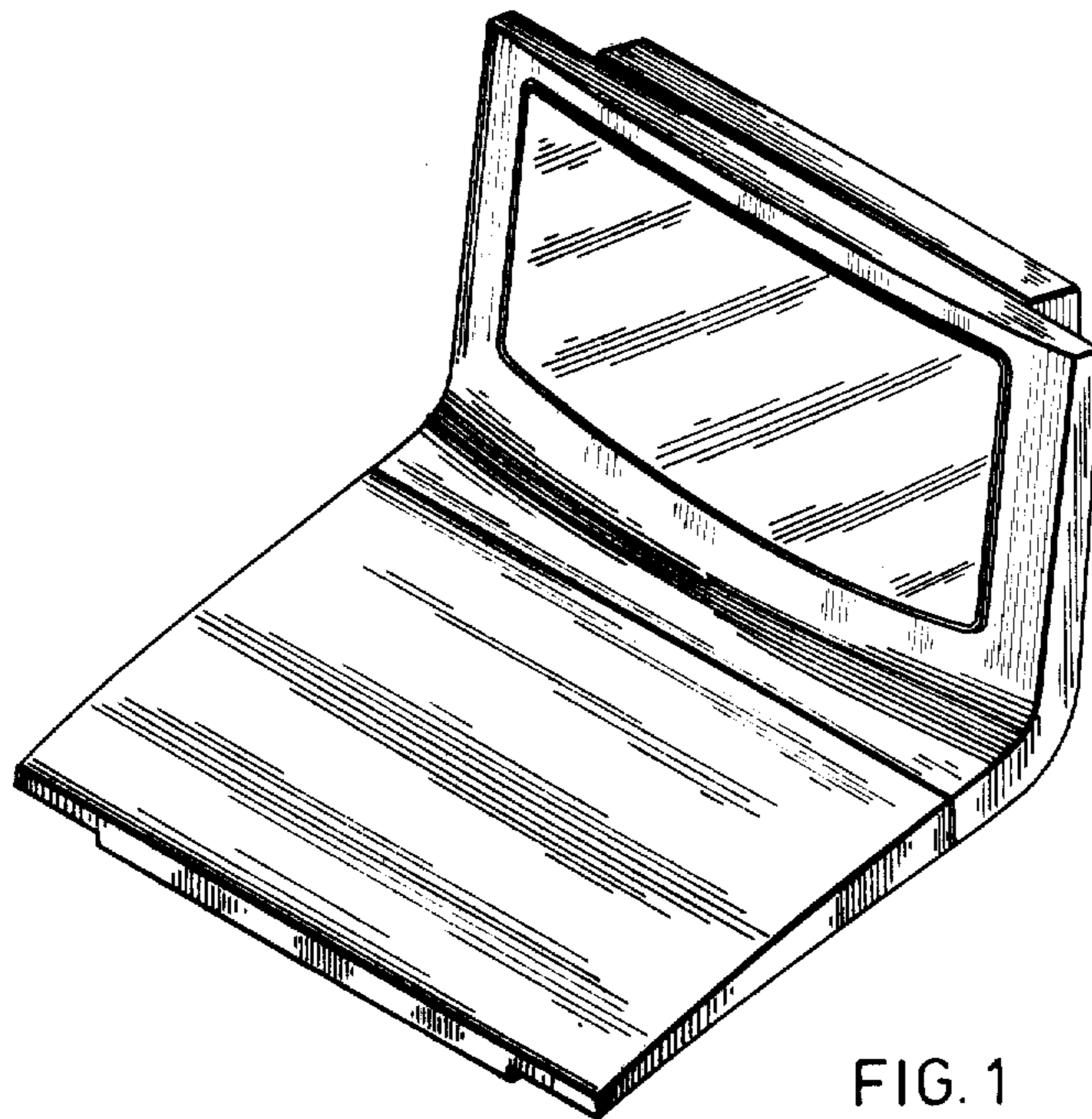

FIG. 1

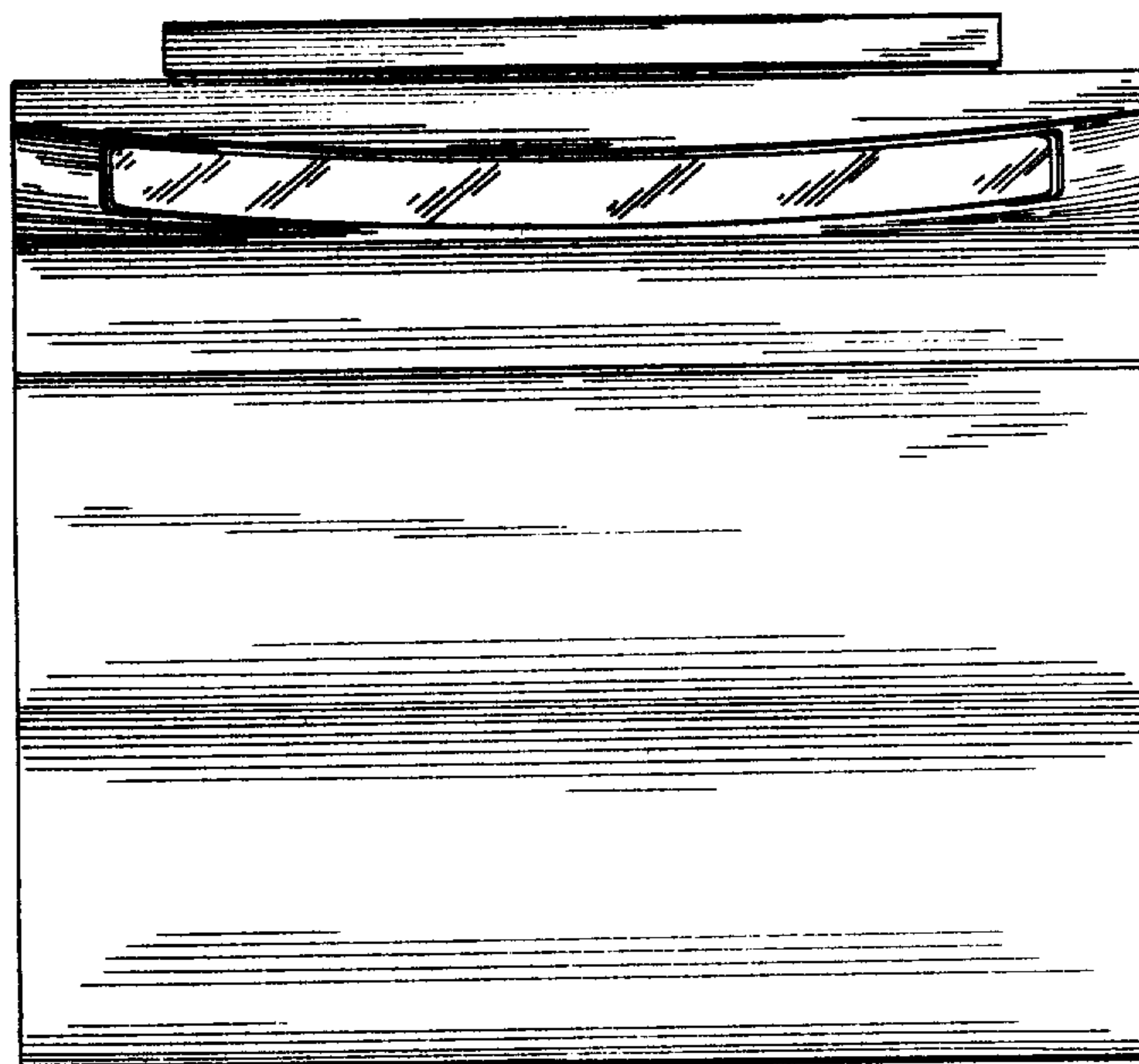

FIG. 2

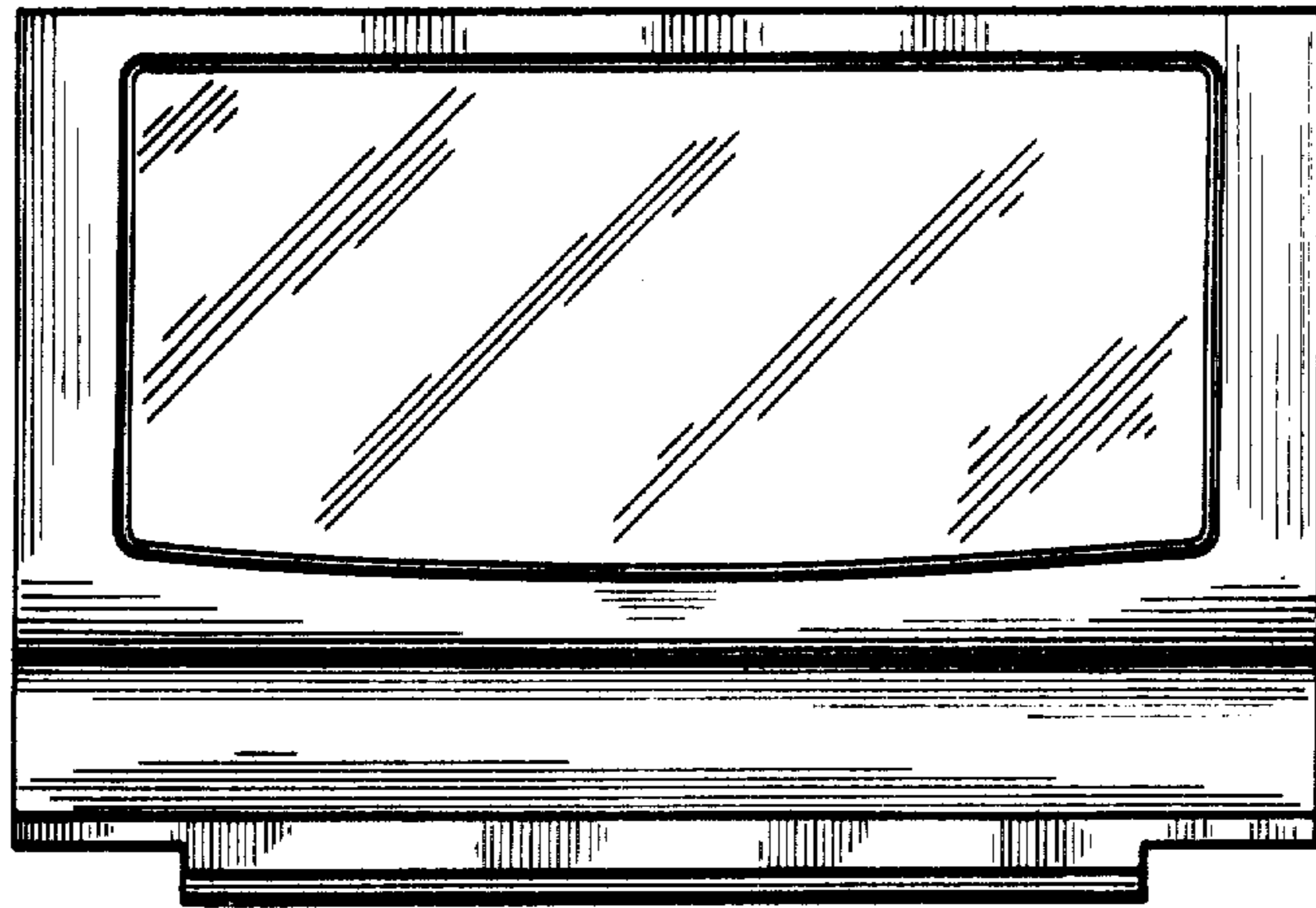

FIG. 3

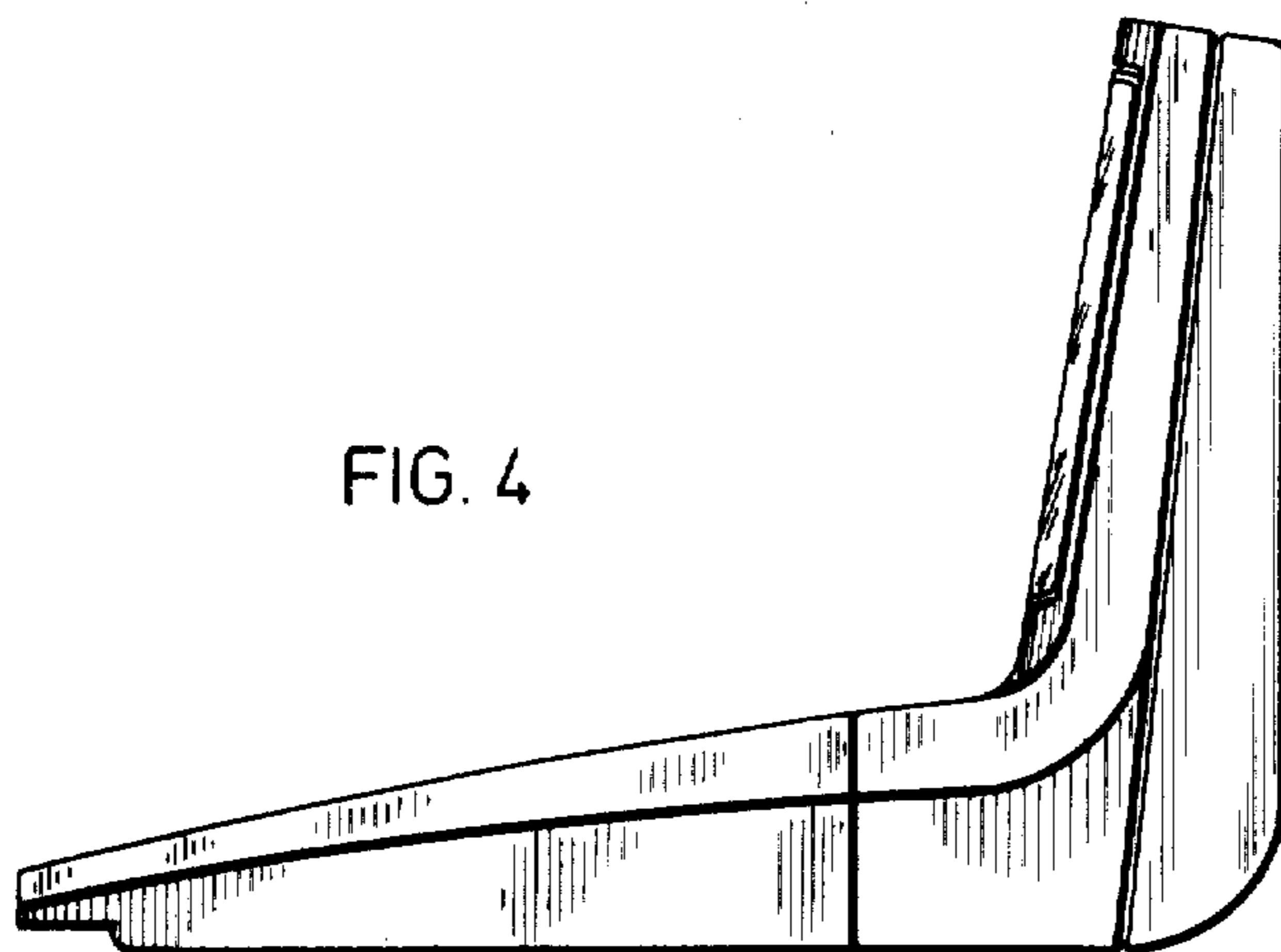

FIG. 4

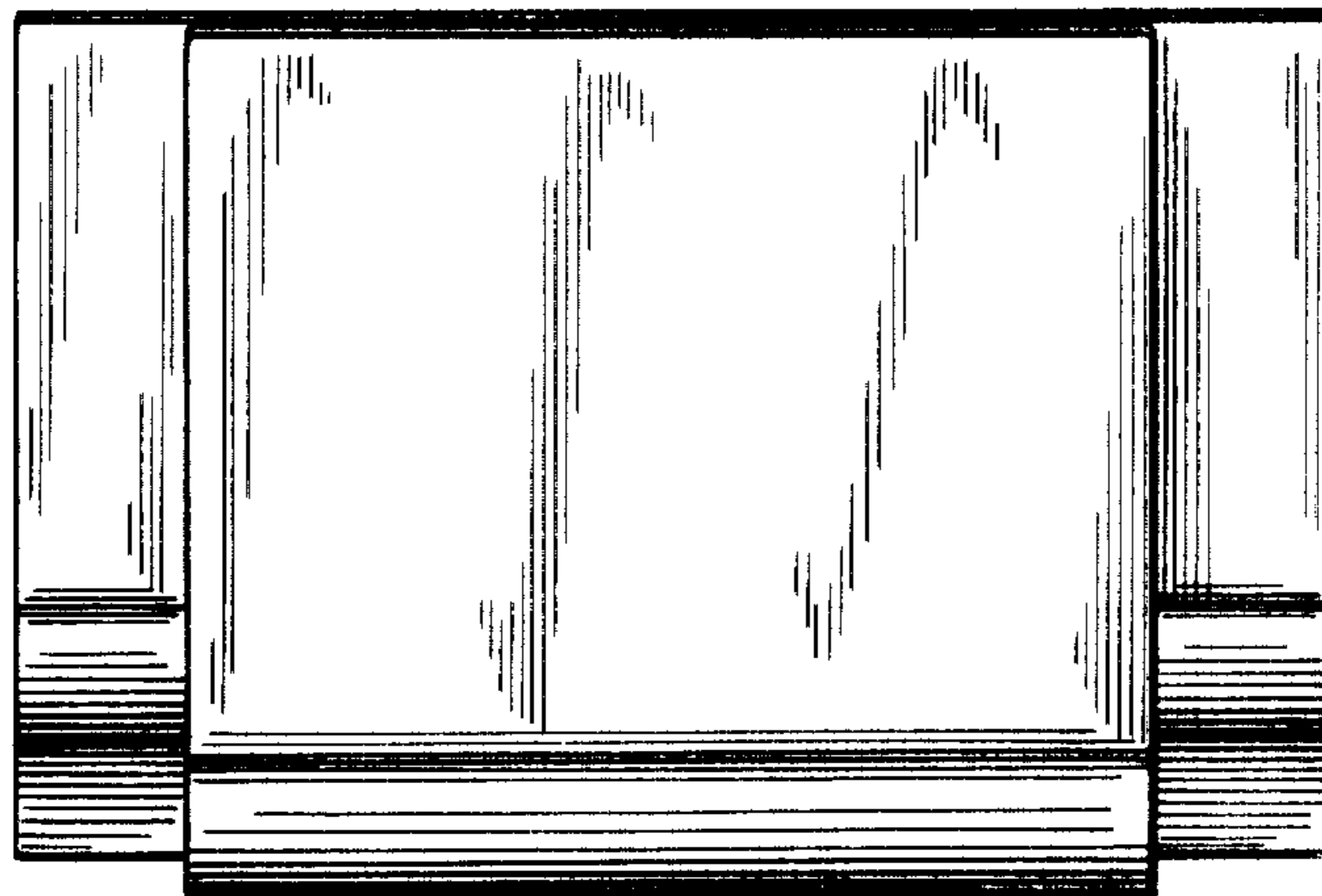

FIG. 5

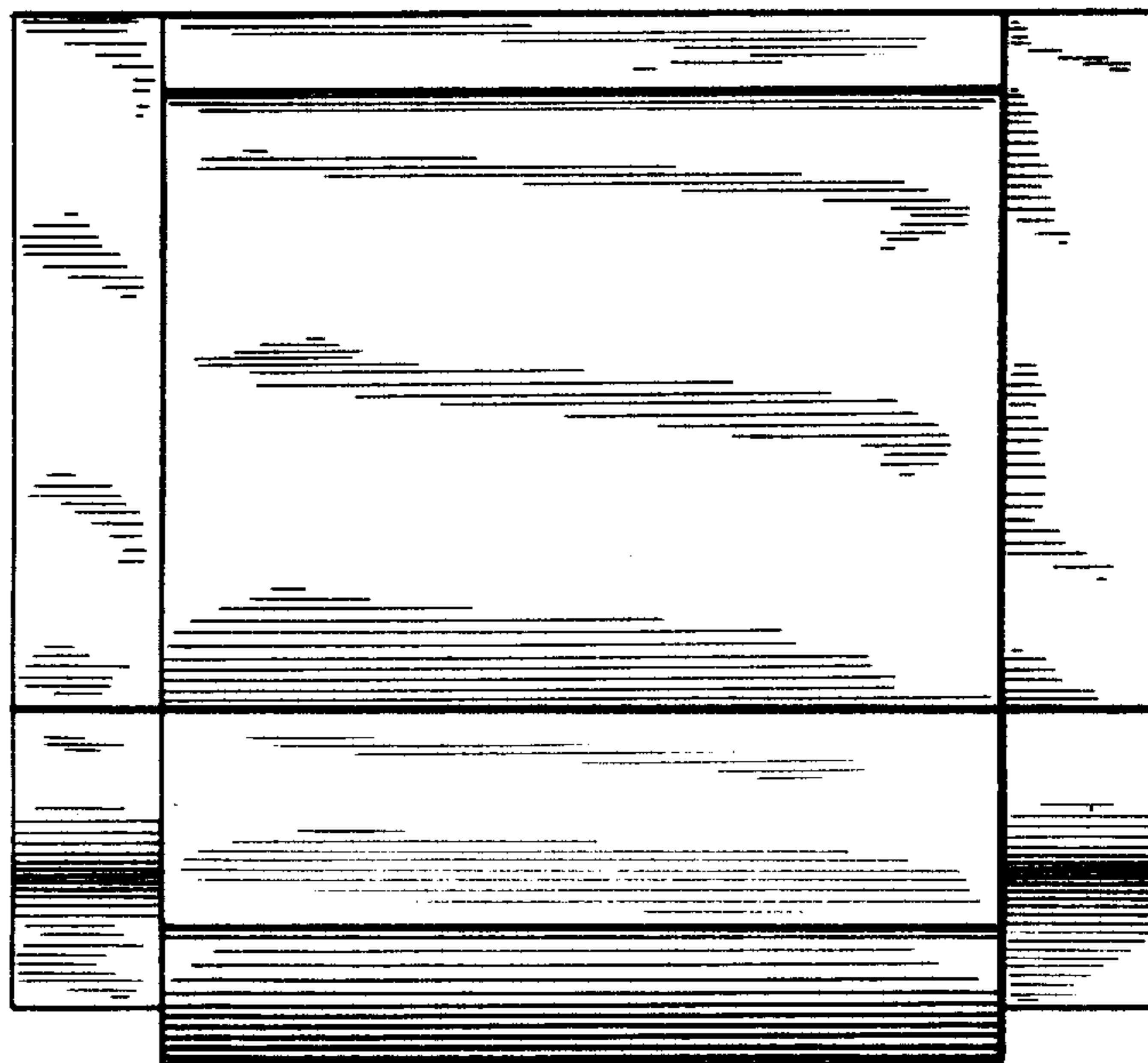

FIG. 6