

[54] CHAIN SAW CASE

[75] Inventors: James C. Carroll, Bartlesville, Okla.; Lewis T. Johnson, Carrollton, Tex.

[73] Assignee: Phillips Petroleum Company, Bartlesville, Okla.

[**] Term: 14 Years

[21] Appl. No.: 226,590

[22] Filed: Jan. 21, 1981

[51] Int. Cl. D3-02

[52] U.S. Cl. D3/72; D3/66

[58] Field of Search D3/30.1, 44, 66, 72, D3/73, 76; 150/52 R; D8/65; D15/133, 134; 206/576

[56] References Cited

U.S. PATENT DOCUMENTS

D. 258,626 3/1981 Dembicks D3/72
4,162,004 7/1979 Thomas 206/349

OTHER PUBLICATIONS

McCulloch Chain Saws, Flyer ©1972, p. 5, Item No. 1.
Sears Craftsman Chain Saws, Flyer 4/73, p. 3, Item No. 1.

Primary Examiner—George P. Word

[57] CLAIM

The ornamental design for a chain saw case, as shown and described.

DESCRIPTION

FIG. 1 is a front elevational view of a chain saw case showing our new design;
FIG. 2 is a rear elevational view;
FIG. 3 is a right side elevational view;
FIG. 4 is a left side elevational view;
FIG. 5 is a top plan view;
FIG. 6 is a bottom plan view;
FIG. 7 is a left rear perspective view; and
FIG. 8 is a right front perspective view.

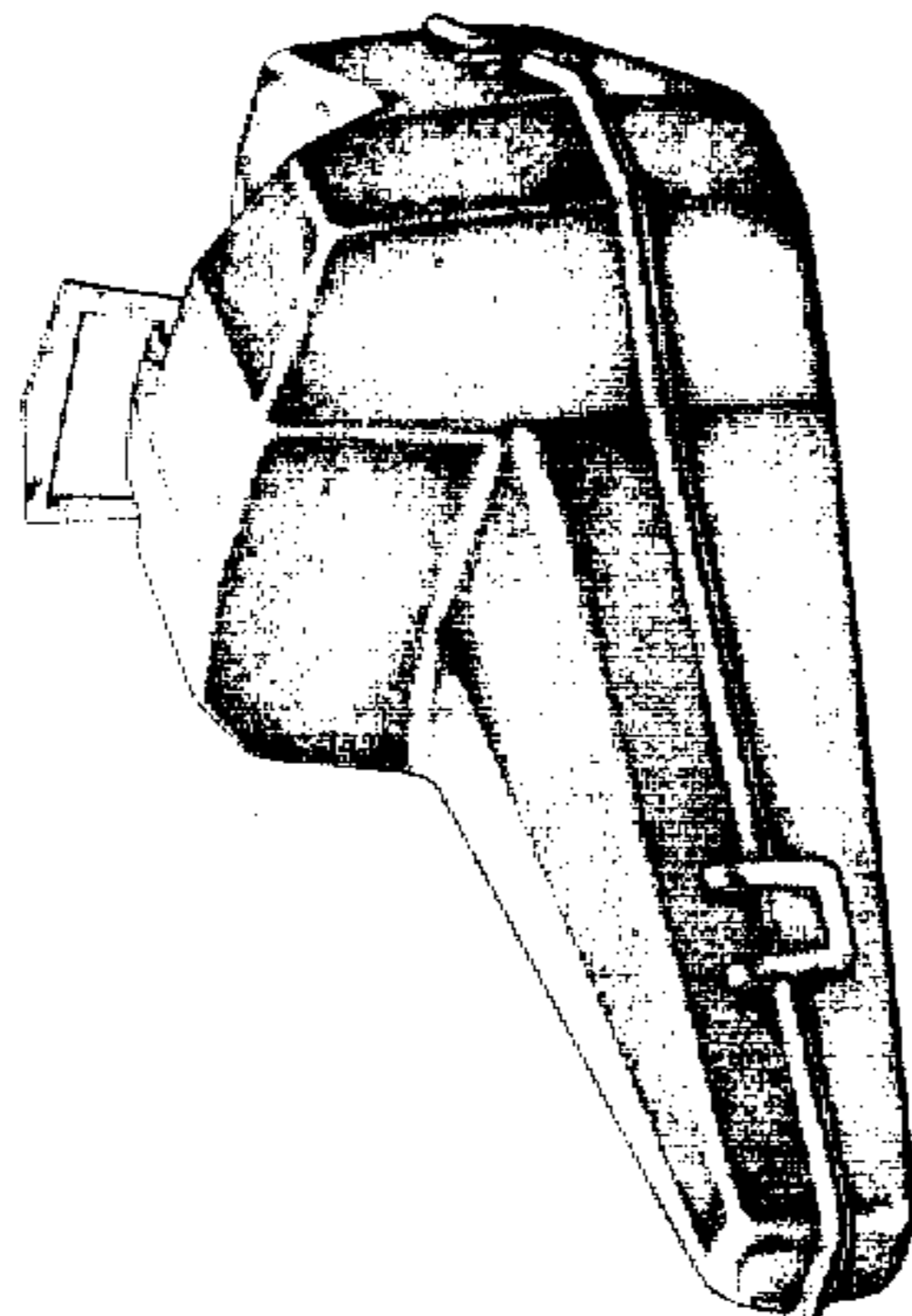

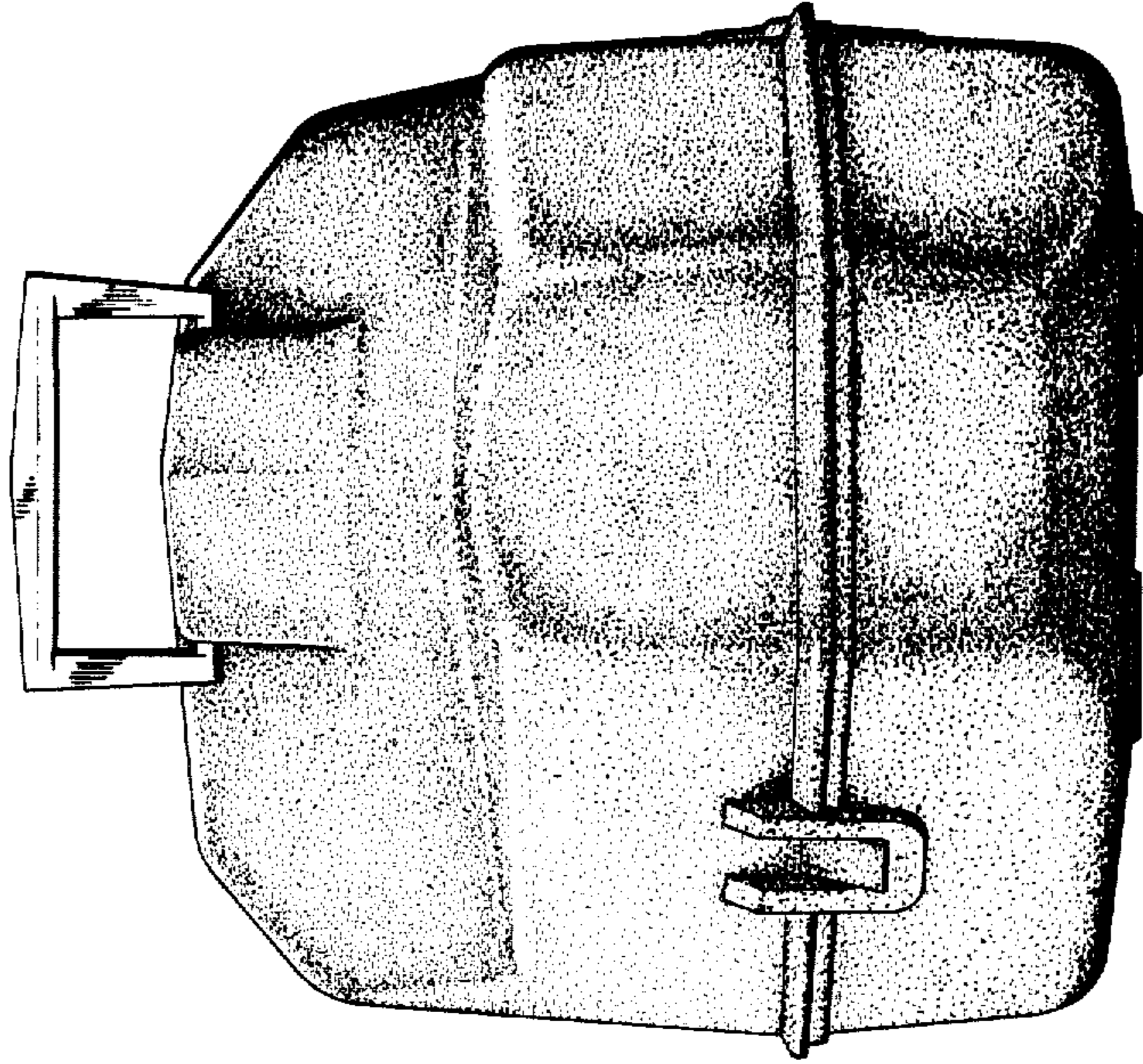

FIG. 2

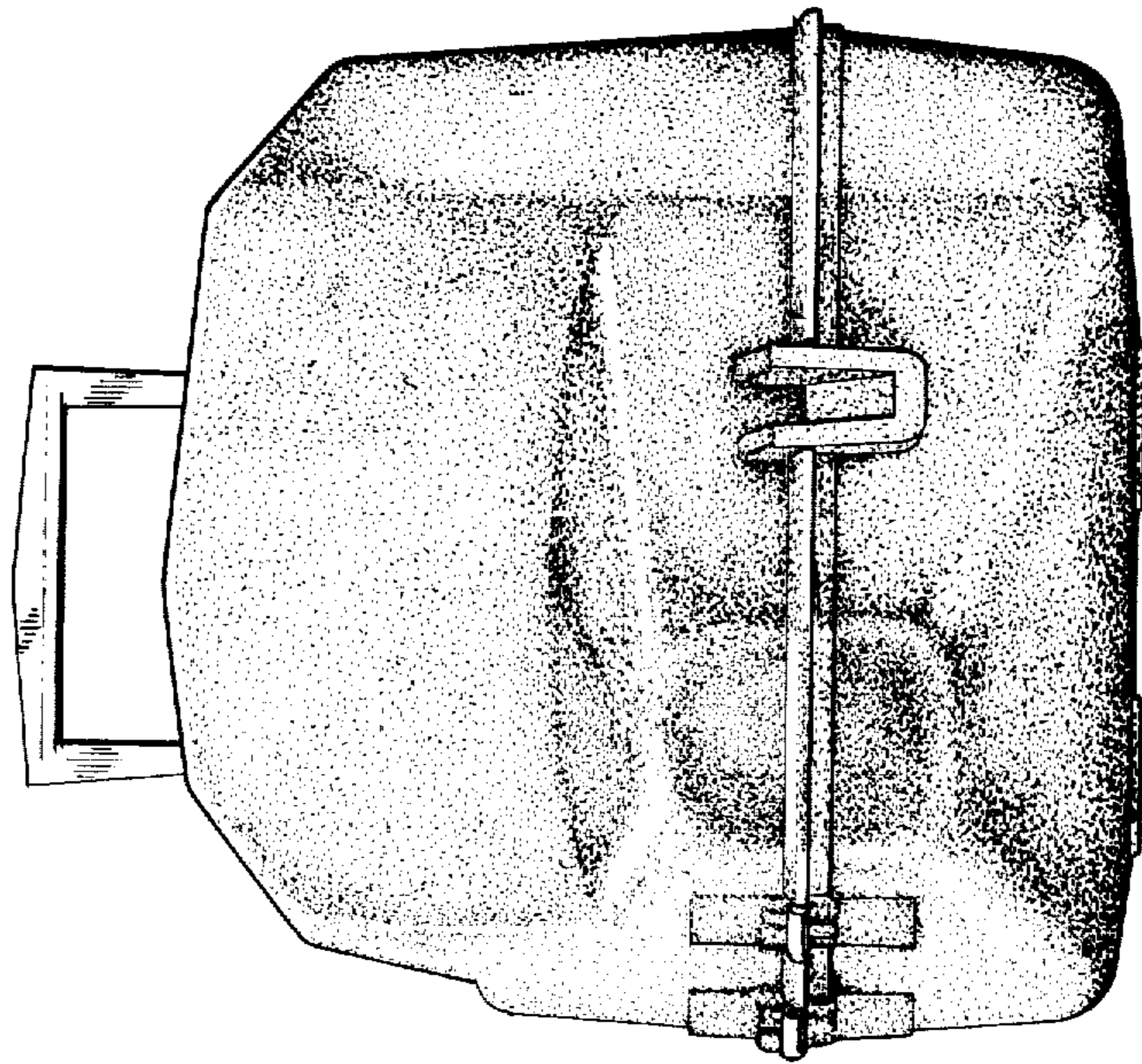

FIG. 1

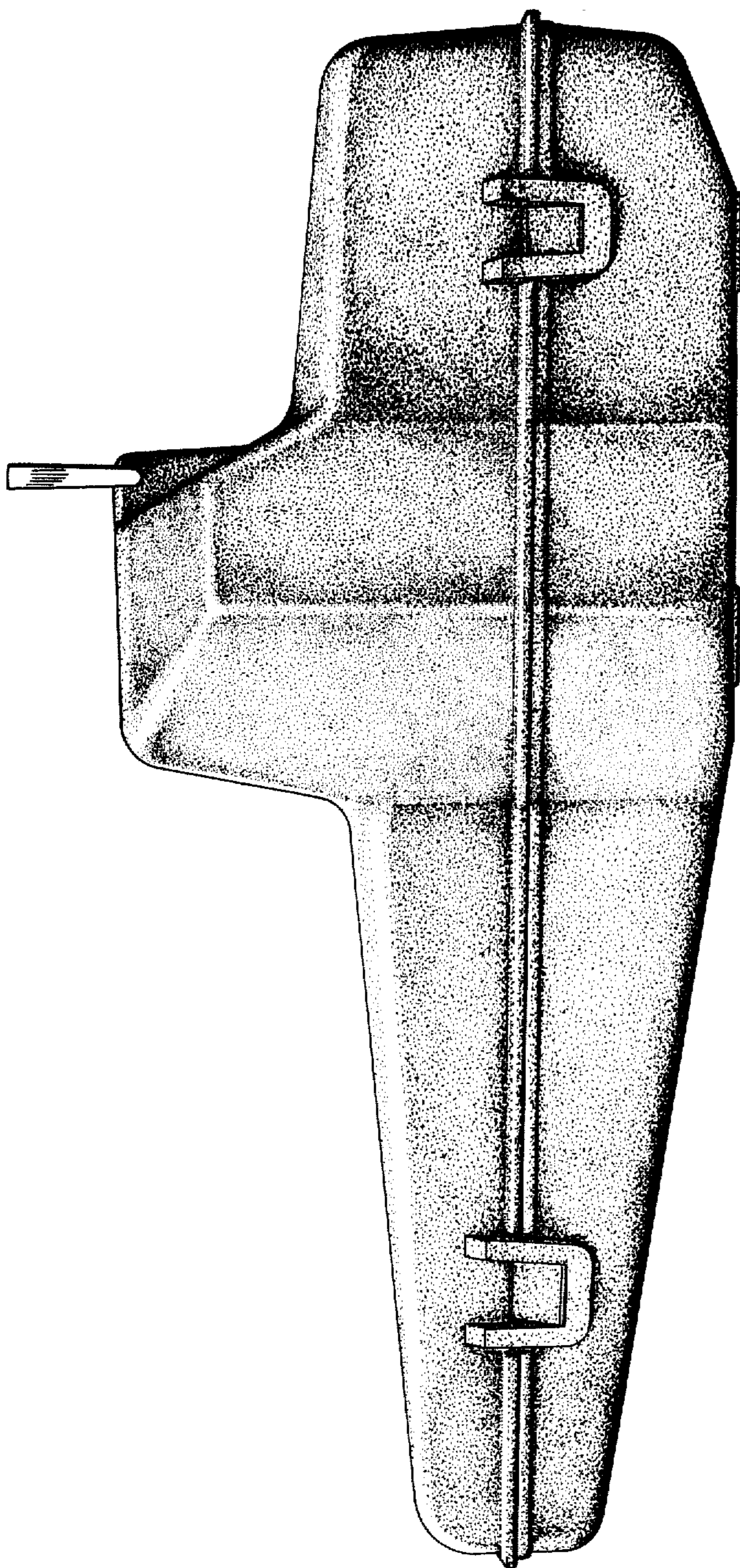

FIG. 3

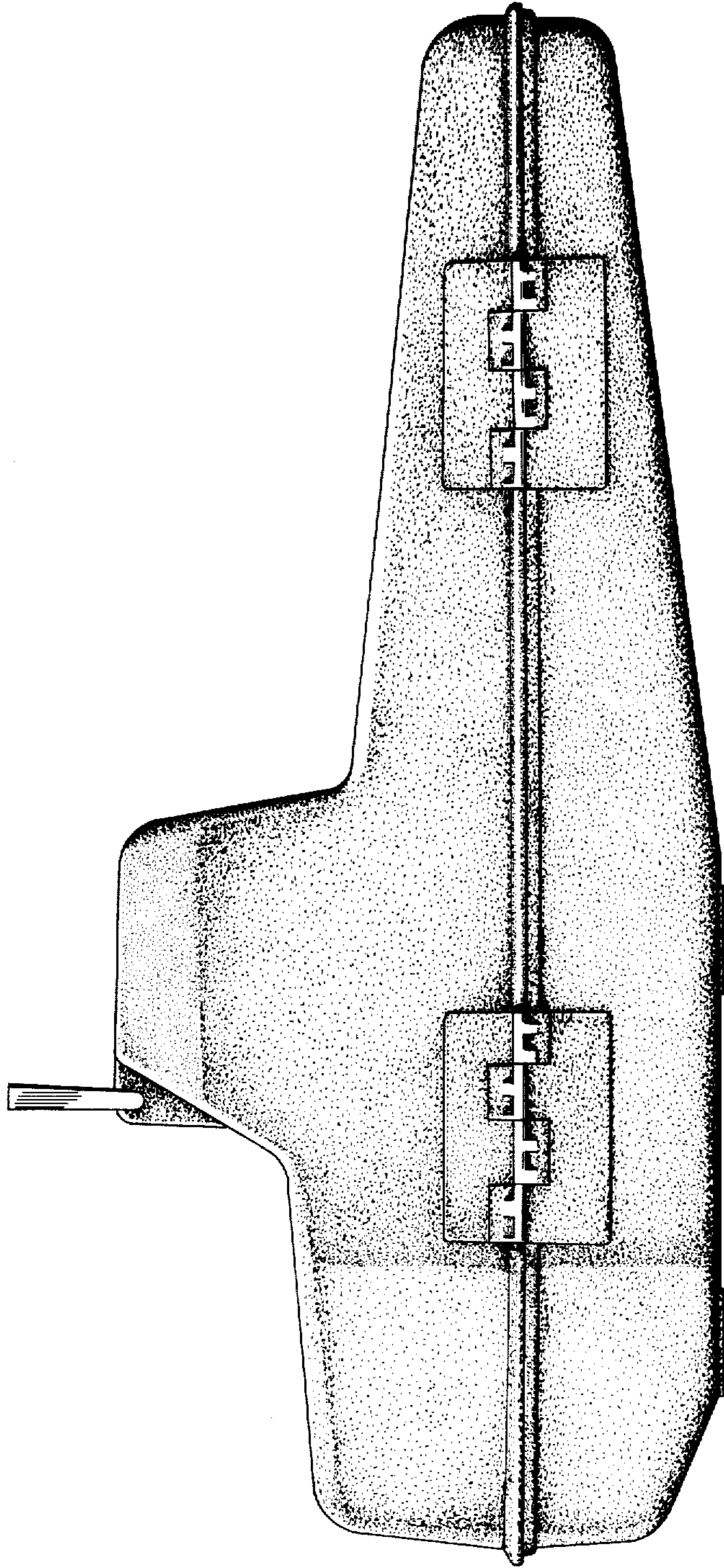

FIG. 4

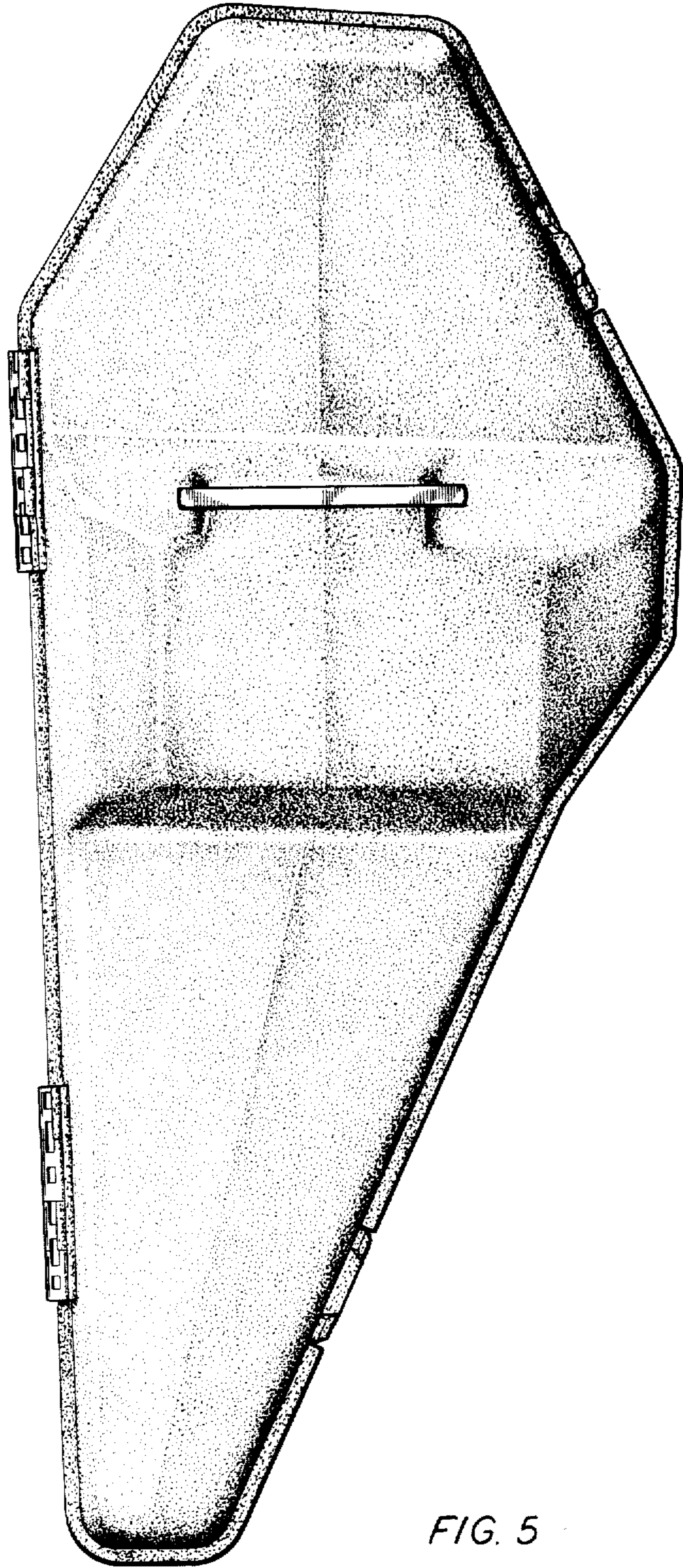

FIG. 5

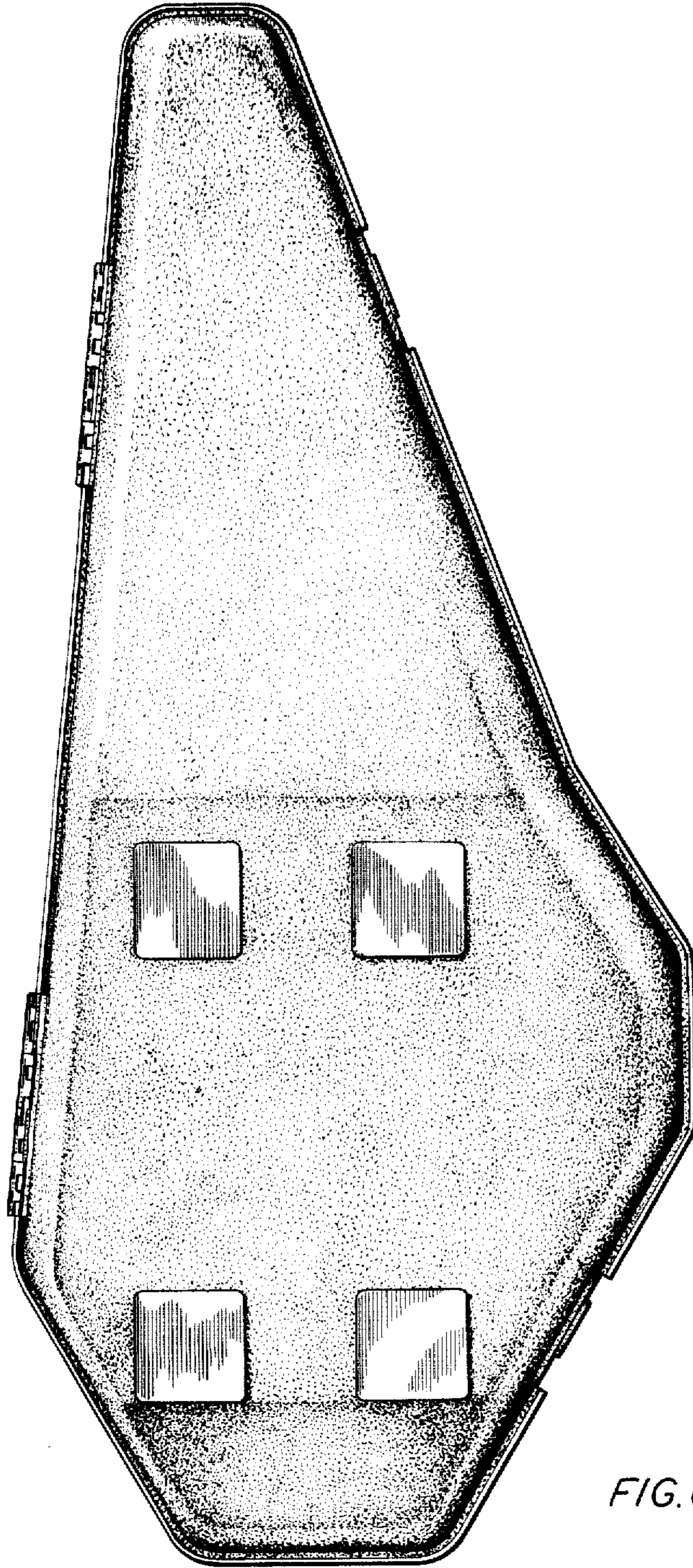

FIG. 6

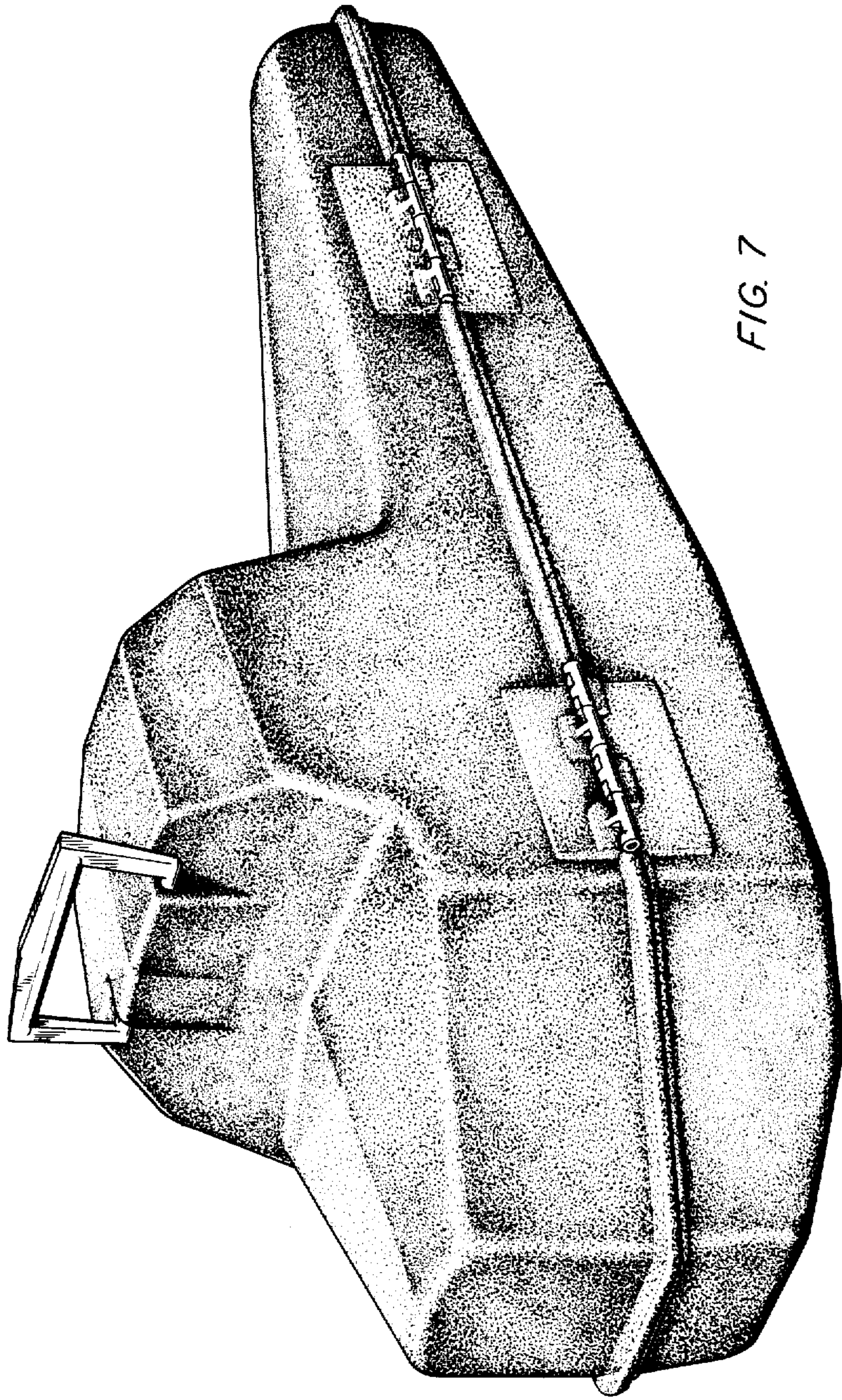

FIG. 7

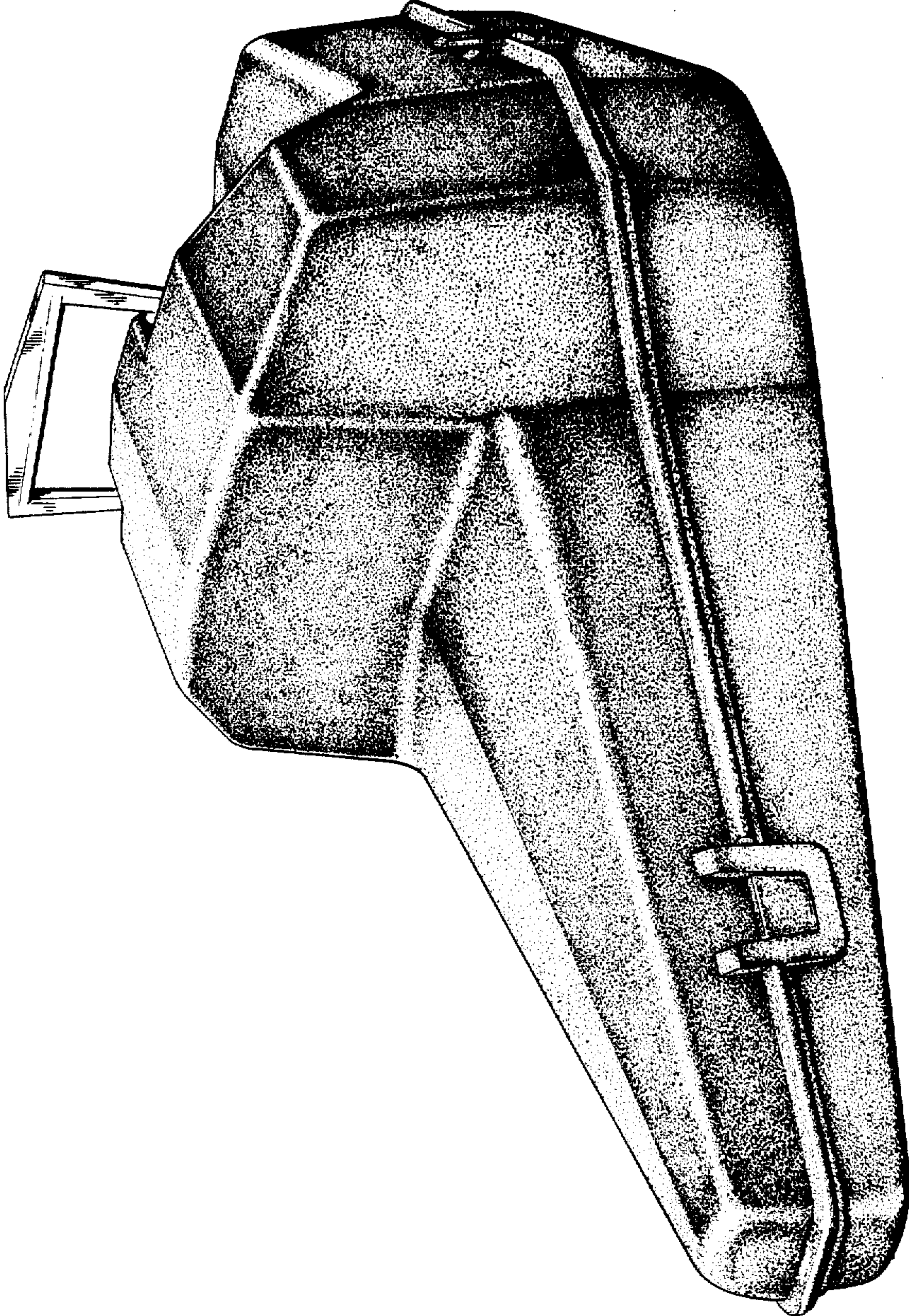

FIG. 8