

[54] **BEVERAGE GLASS OR SIMILAR ARTICLE**

[75] Inventor: **James L. Thrush**, Lancaster, Ohio

[73] Assignee: **Anchor Hocking Corporation**, Lancaster, Ohio

[\*\*] Term: **14 Years**

[21] Appl. No.: **140,180**

[22] Filed: **Apr. 14, 1980**

[51] Int. Cl. .... **D07—01**

[52] U.S. Cl. .... **D7/11; D7/13; D7/14**

[58] Field of Search ..... **D7/3, 6, 7, 8, 11-15, D7/22; D9/398, 428, 429, 395**

[56] **References Cited**

**U.S. PATENT DOCUMENTS**

D. 47,684	8/1915	Blaze	.....	D7/13
D. 182,376	3/1958	Moslo	.....	D7/14
D. 184,976	4/1959	Bloch	.....	D7/14
D. 246,219	11/1977	Harbaugh et al.	.....	D7/13
D. 247,867	5/1978	Thrush	.....	D7/14
D. 249,919	10/1978	Thrush	.....	D7/14

**OTHER PUBLICATIONS**

*Gifts & Tableware*, Dec. 1978, p. 106, "Longchamp" by J. G. Durand, left & center Goblets.

*Anchor Hocking 67 Glassware Cat.*, p. 22, "La Reine" Stemware, Items #2402 Brandy, #2411 Goblet, #2410 Beer Goblet.

*Better Homes & Gardens*, Mar. 1976, p. Z-7, Fostoria Lead Crystal Tumbler shown.

*Fostoria Glass Co. Cat.*, p. 16, "Stratton" Facets, Goblets #ST 04/002, #ST 04/026, #ST 04/063.

*Primary Examiner*—Winifred E. Herrmann

*Attorney, Agent, or Firm*—Holland, Armstrong, Wilkie & Previto

[57] **CLAIM**

The ornamental design for a beverage glass or similar article, substantially as shown and described.

**DESCRIPTION**

FIG. 1 is an elevational view of a beverage glass or similar article showing my new and ornamental design in the size and proportions of a goblet;

FIG. 2 is a top plan view thereof;

FIG. 3 is a sectional view taken along line 3—3 of FIG. 1;

FIG. 4 is a sectional view taken along line 4—4 of FIG. 1;

FIG. 5 is a sectional view taken along line 5—5 of FIG. 1;

FIG. 6 is a sectional view taken along line 6—6 of FIG. 1;

FIG. 7 is an elevational view of my new and ornamental design in the size and proportions of a cordial glass;

FIG. 8 is a top plan view thereof;

FIG. 9 is a sectional view taken along line 9—9 of FIG. 7;

FIG. 10 is a sectional view taken along line 10—10 of FIG. 7;

FIG. 11 is a sectional view taken along line 11—11 of FIG. 7;

FIG. 12 is a sectional view taken along line 12—12 of FIG. 7;

FIG. 13 is an elevational view of my new and ornamental design in the size and proportions of a pilsner glass;

FIG. 14 is a top plan view thereof;

FIG. 15 is a sectional view taken along line 15—15 of FIG. 13;

FIG. 16 is a sectional view taken along line 16—16 of FIG. 13;

FIG. 17 is a sectional view taken along line 17—17 of FIG. 13; and

FIG. 18 is a sectional view taken along line 18—18 of FIG. 13.

The facets showing through the sectional views in FIGS. 3, 4, 5, 9, 10, 11, 15, 16 and 17 have been eliminated for convenience of illustration.

The base has been eliminated from FIGS. 4, 5, 6, 10, 11, 12, 16, 17 and 18 for convenience of illustration.

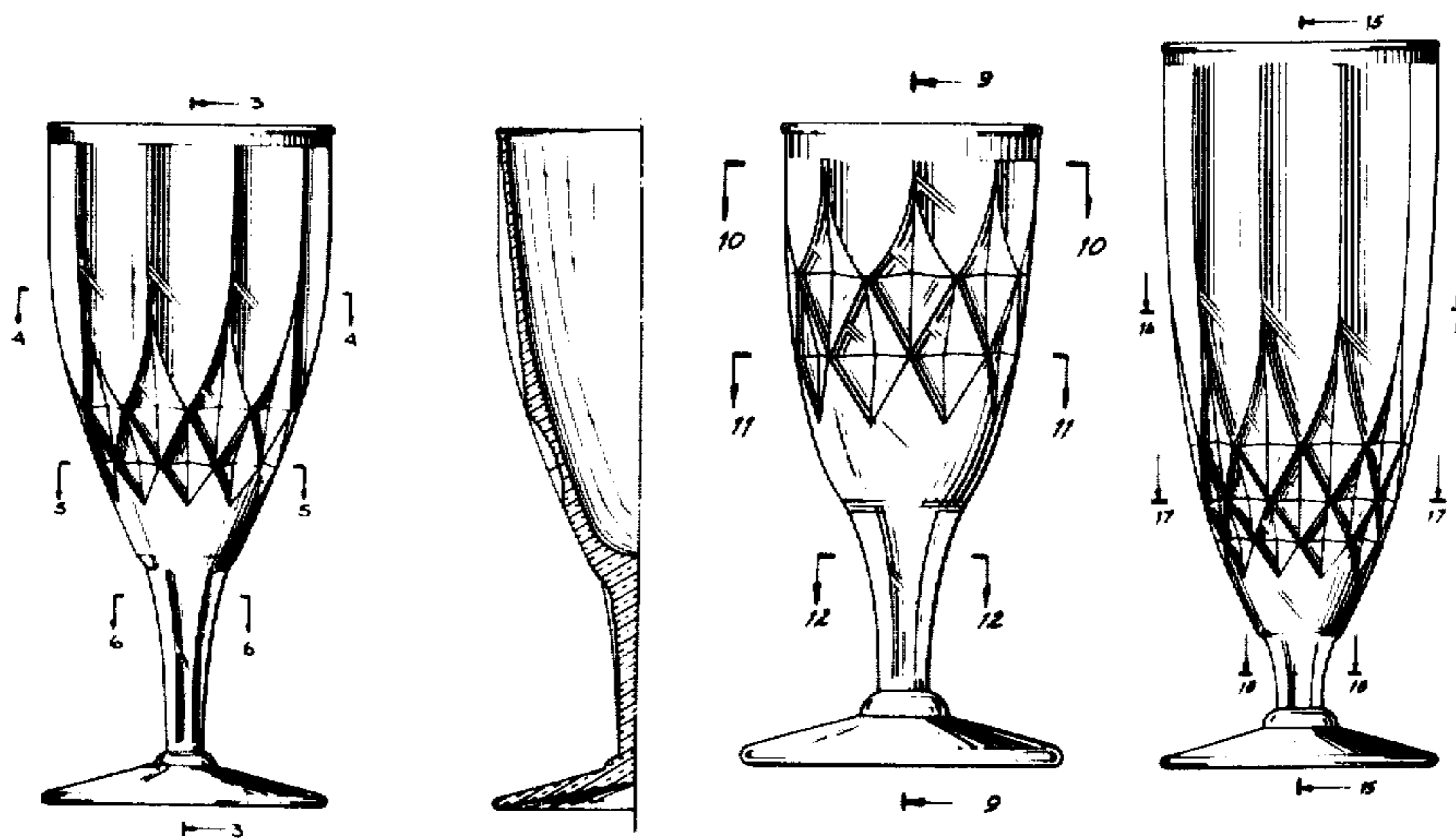

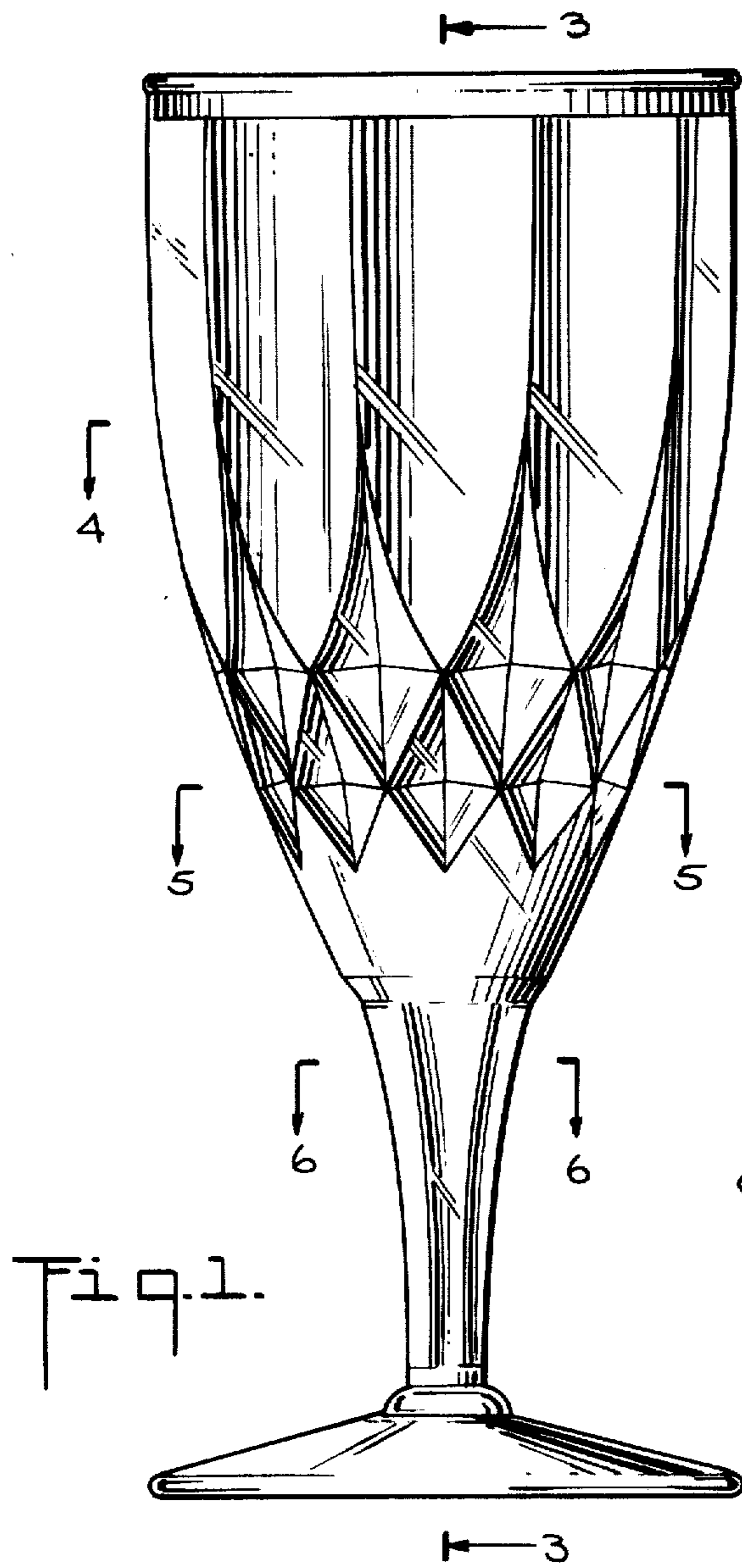

Fig. 1.

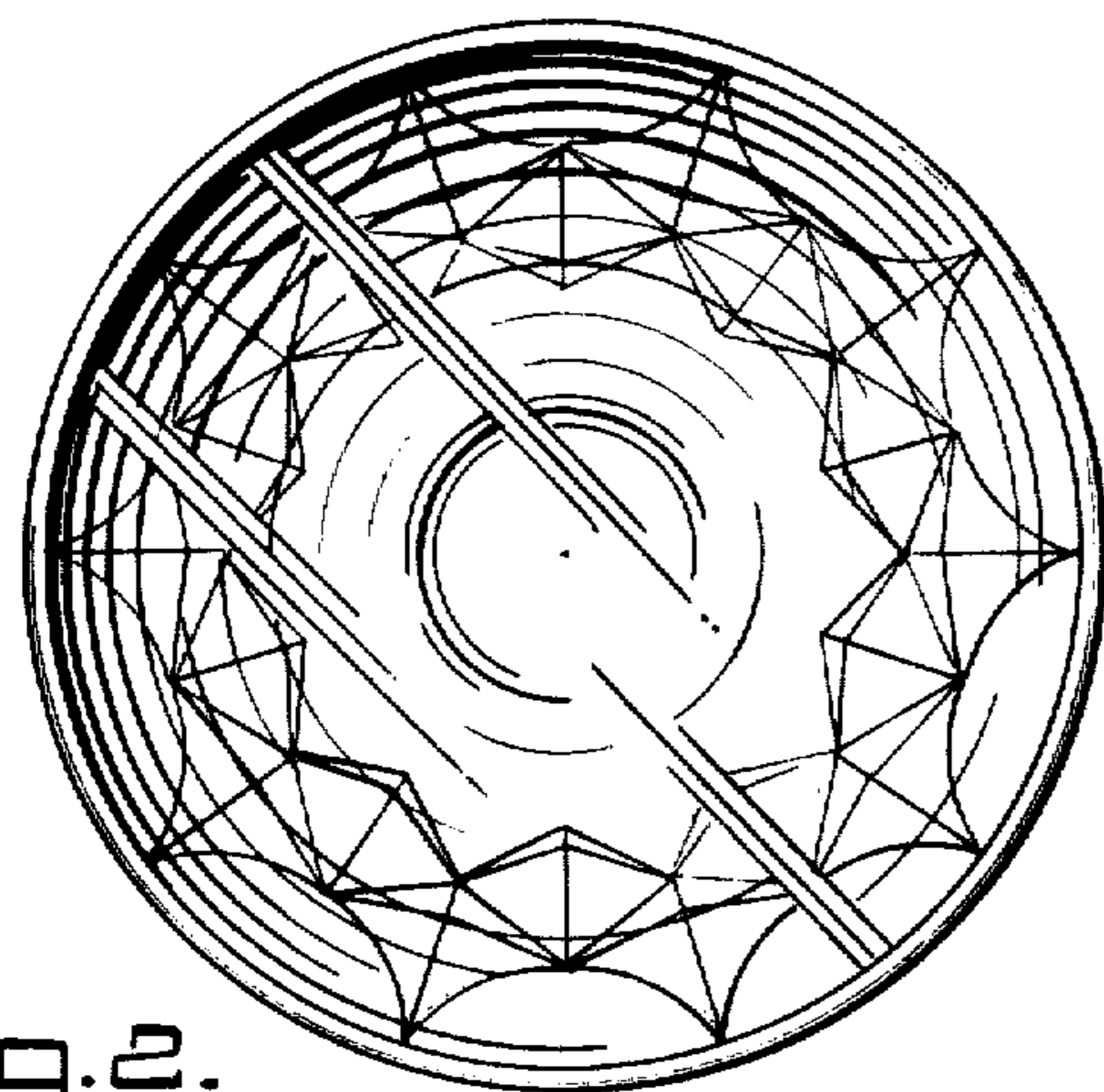

Fig. 2.

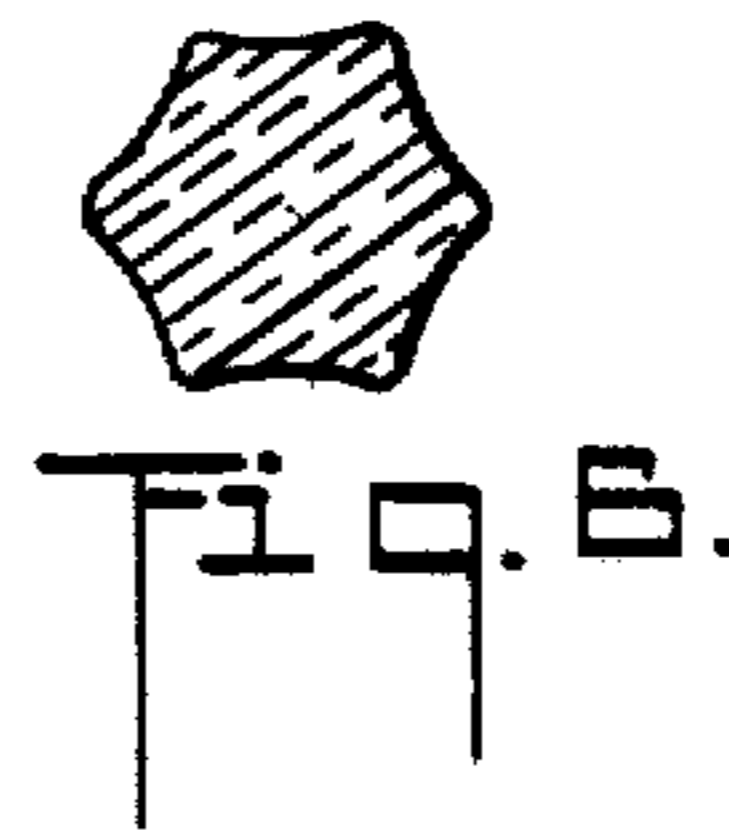

Fig. 3.

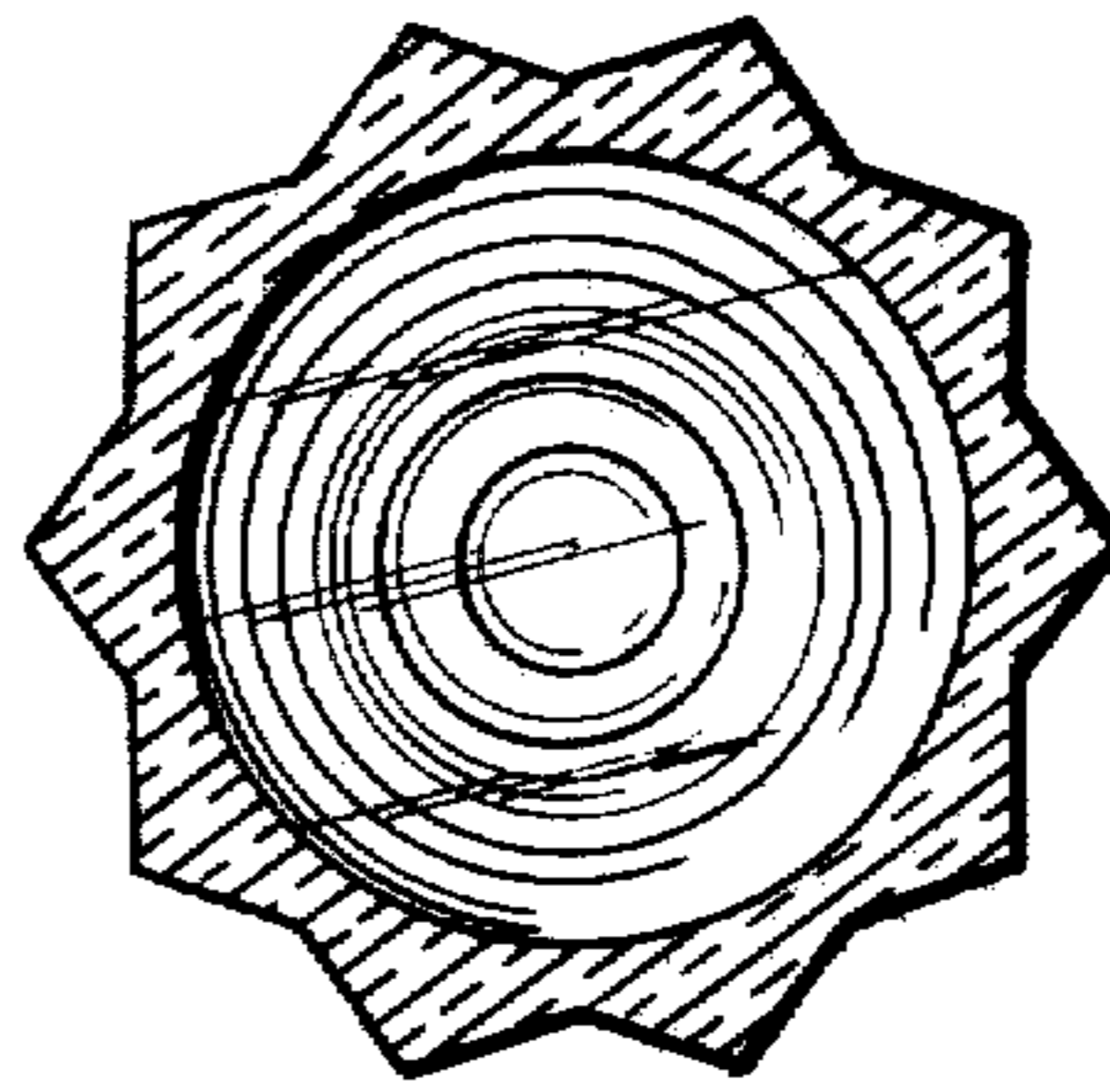

Fig. 4.

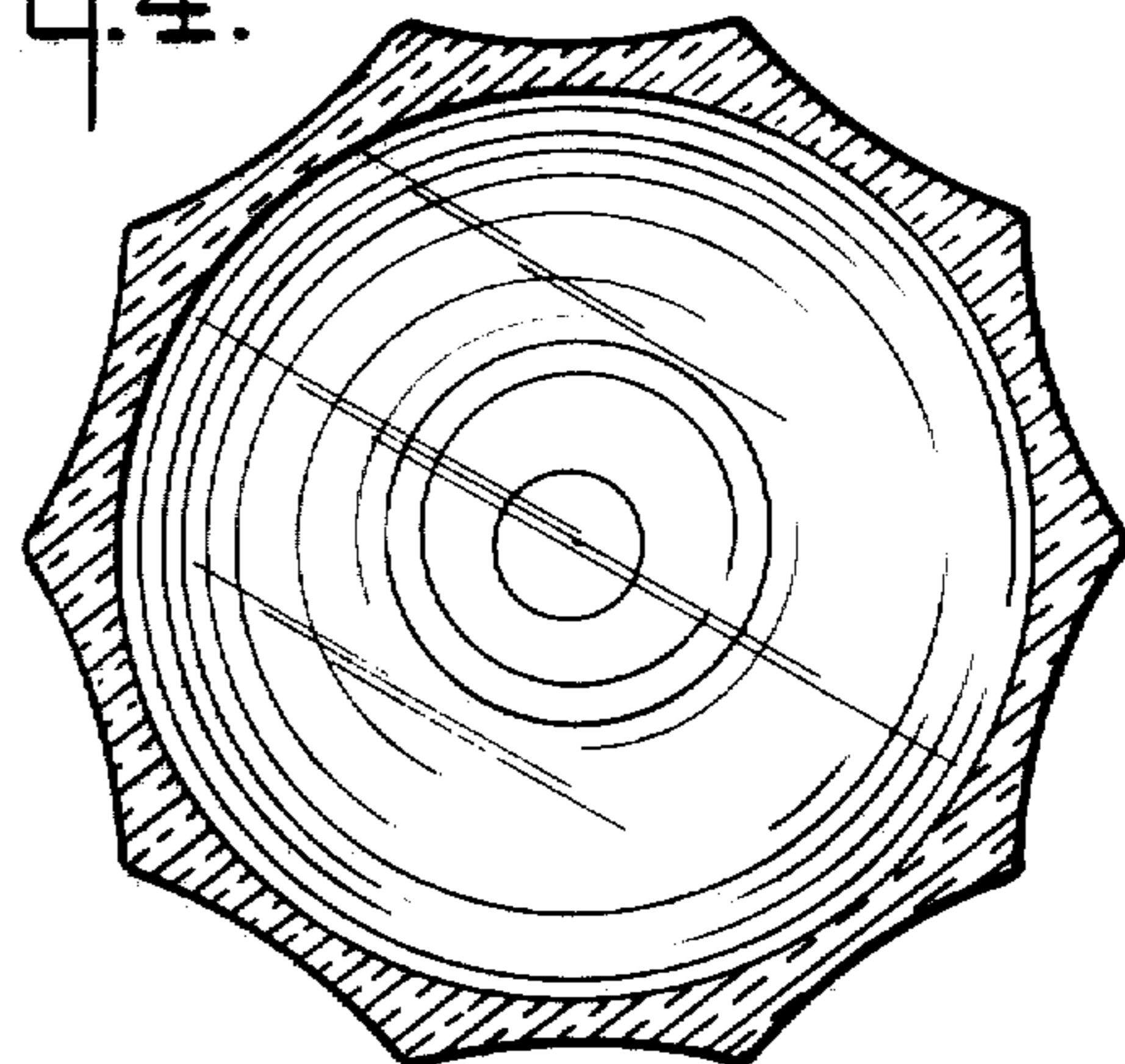

Fig. 5.

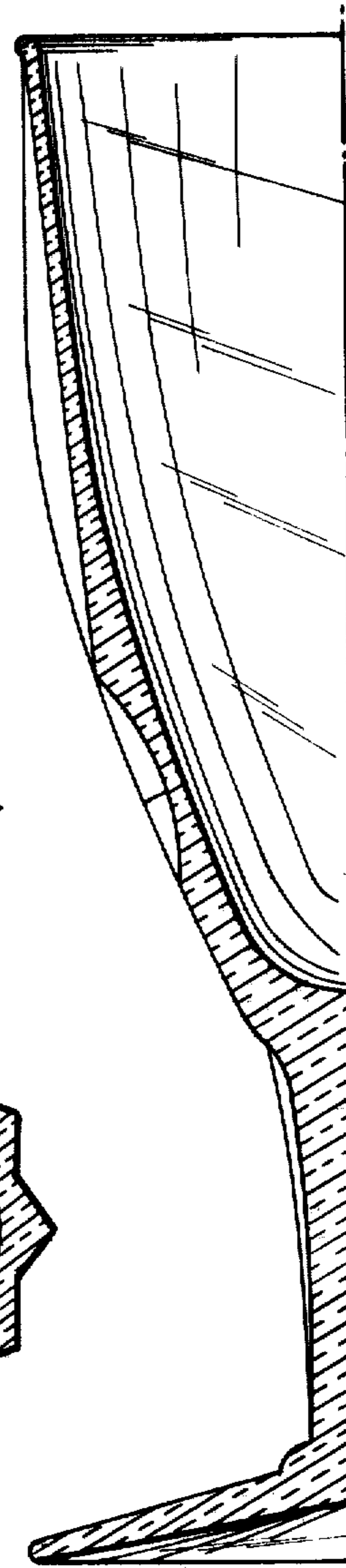

Fig. 6.

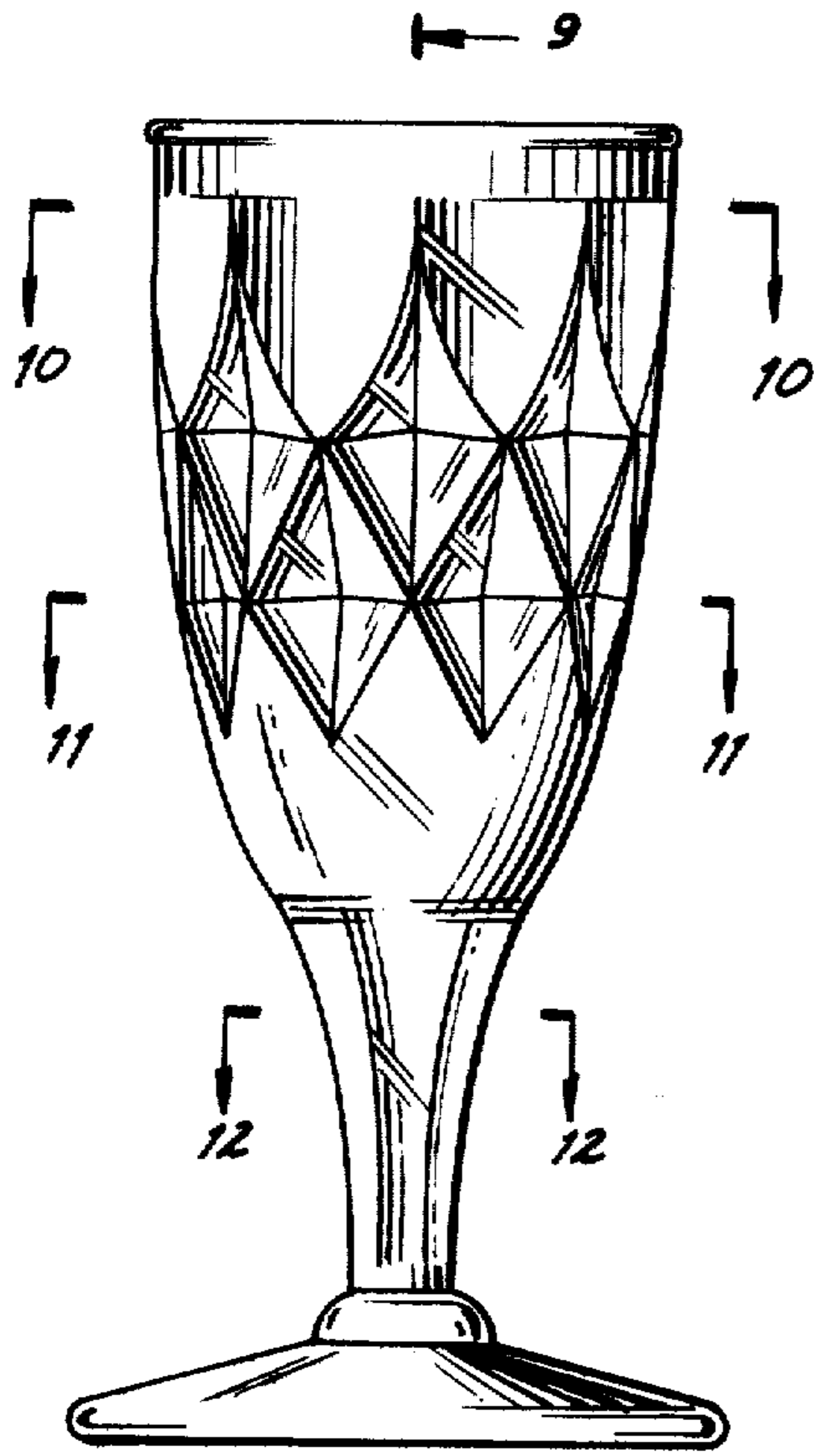

Fig. 2.

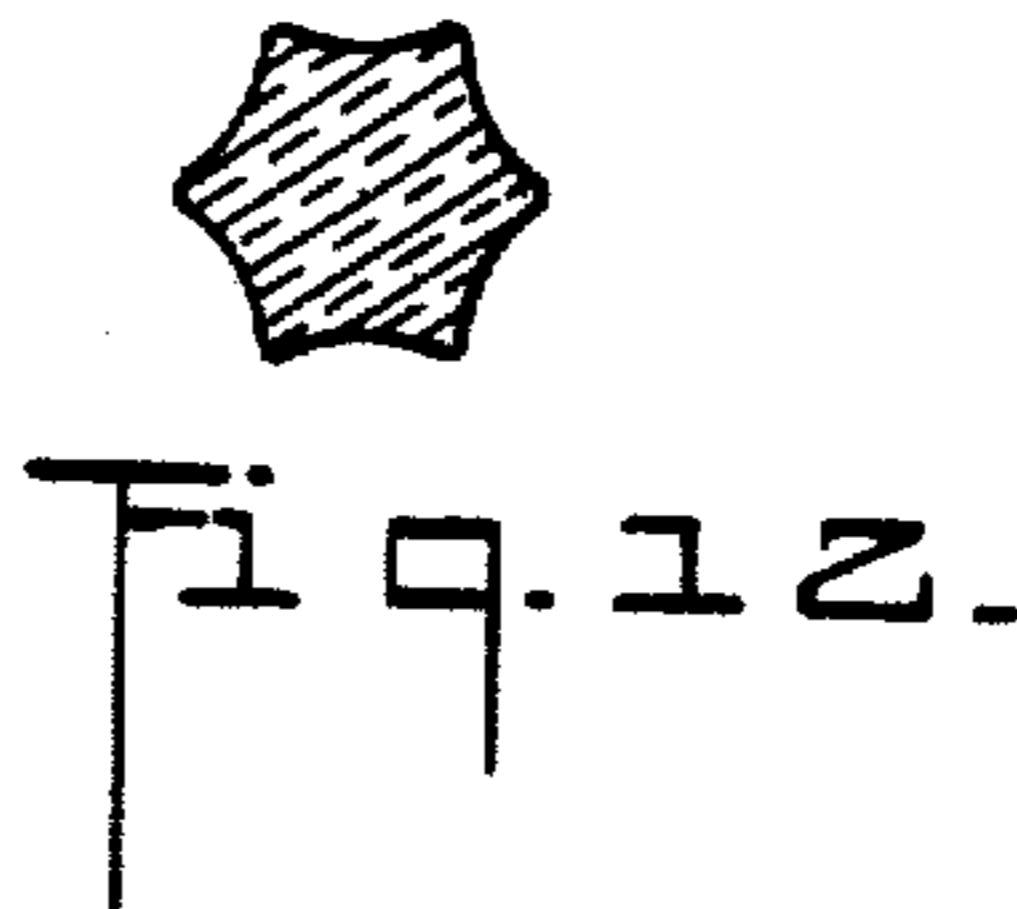

Fig. 12.

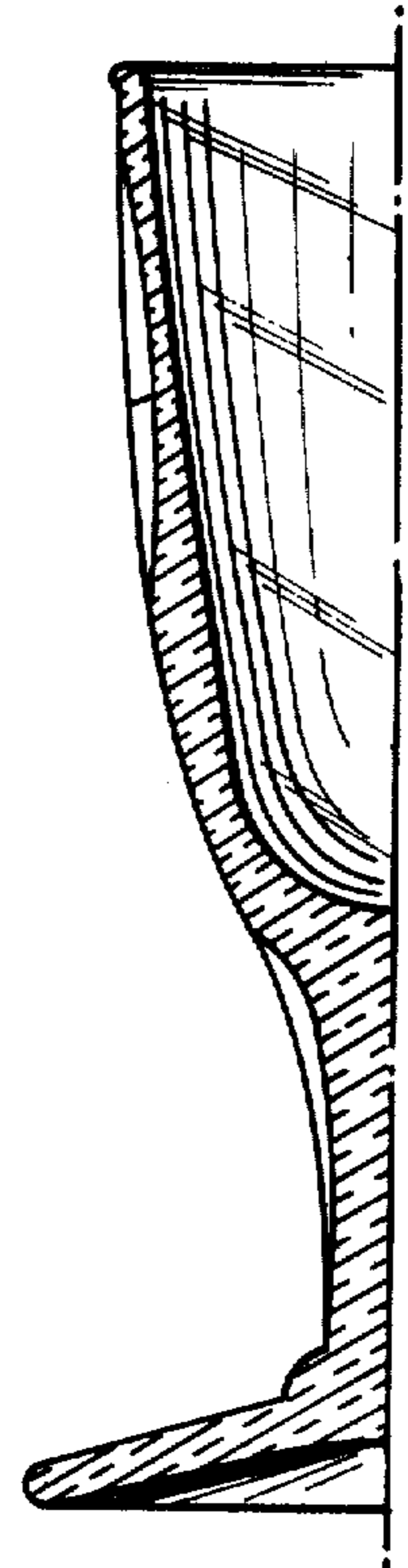

Fig. 9.

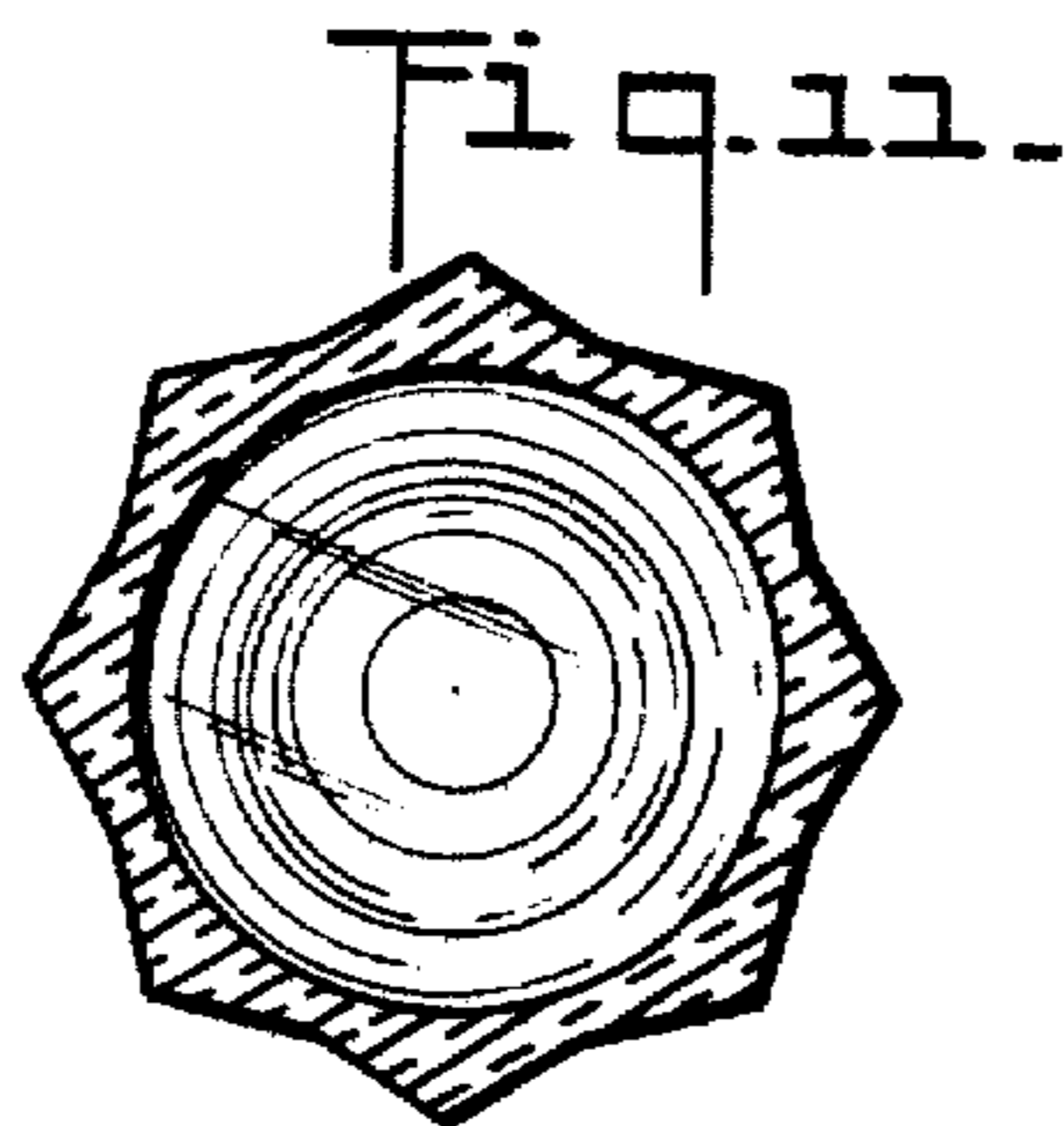

Fig. 11.

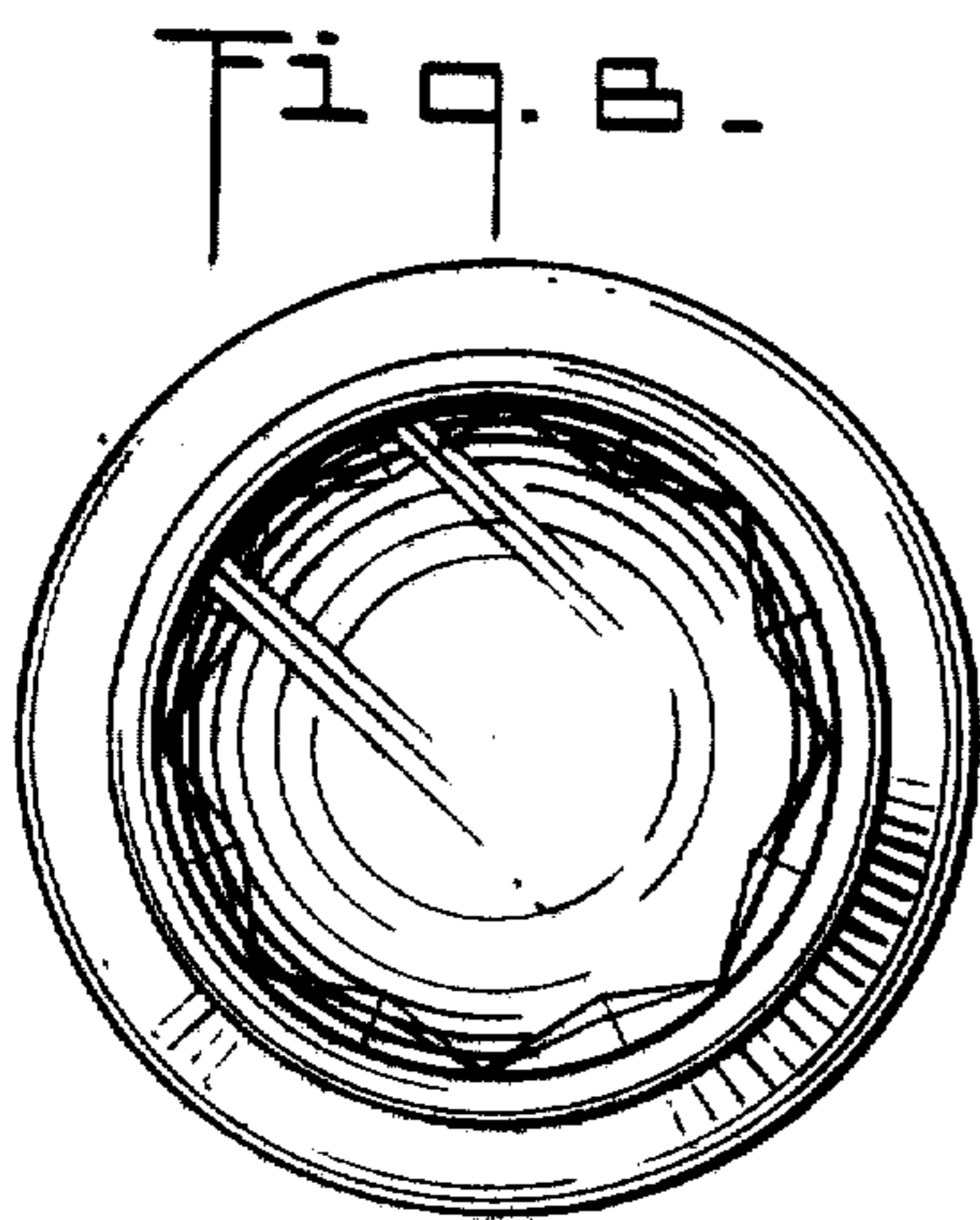

Fig. 8.

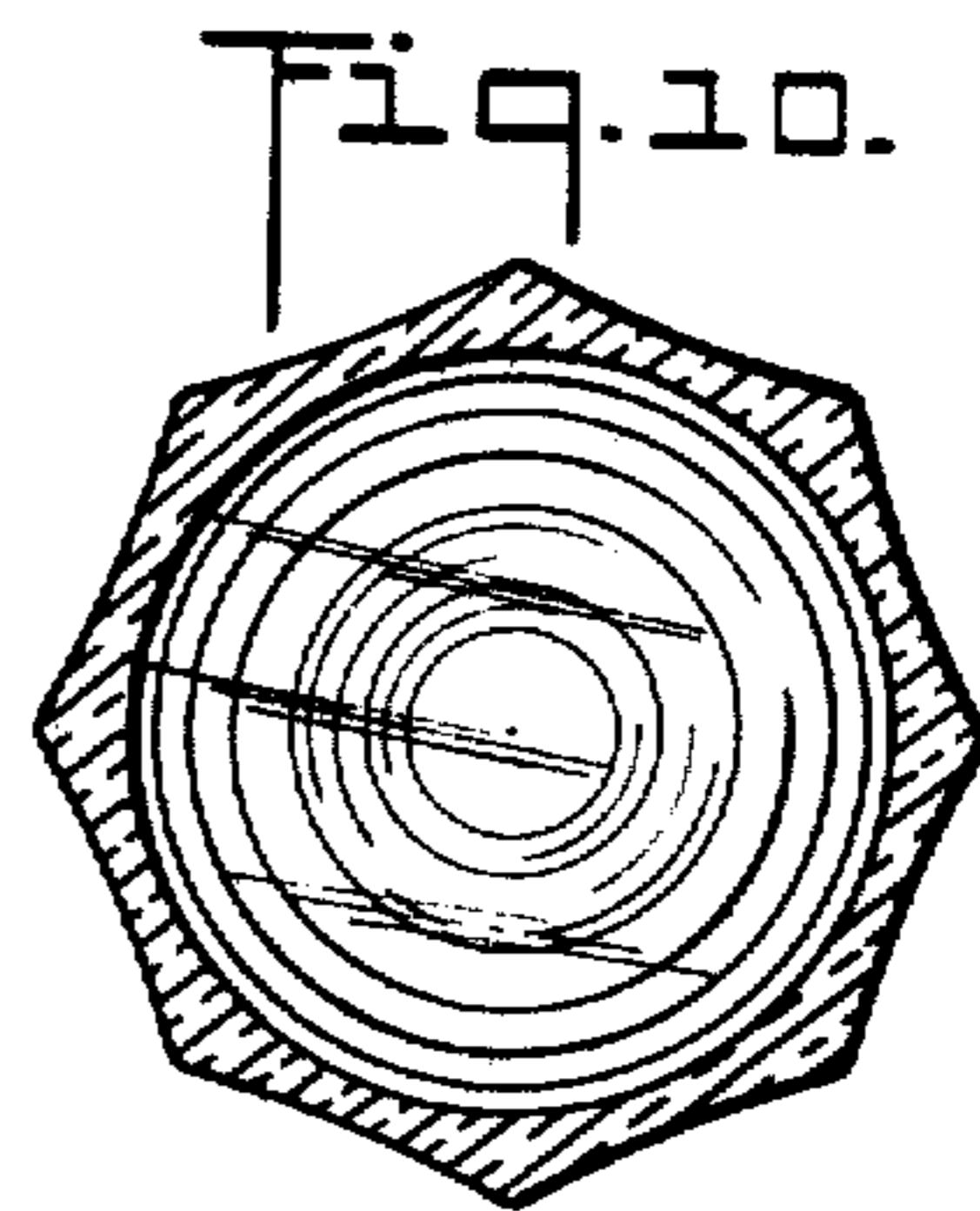

Fig. 10.

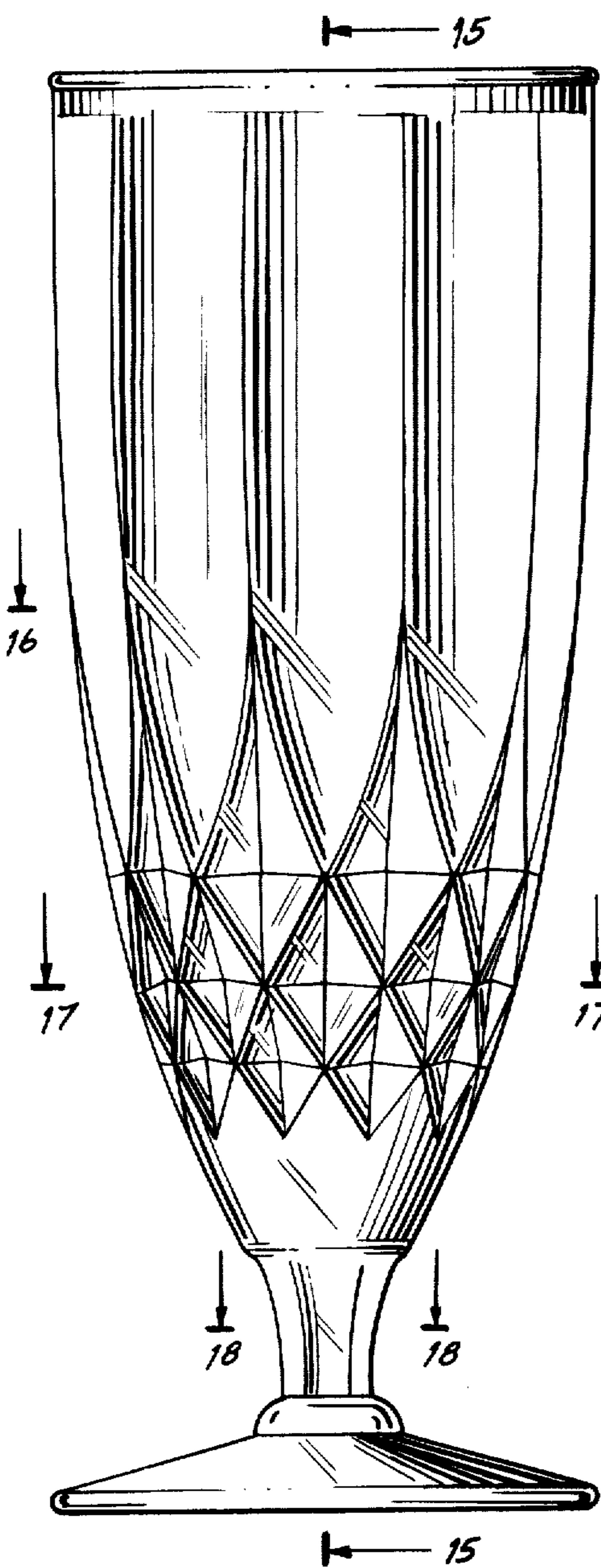

Fig. 13.

Fig. 15.

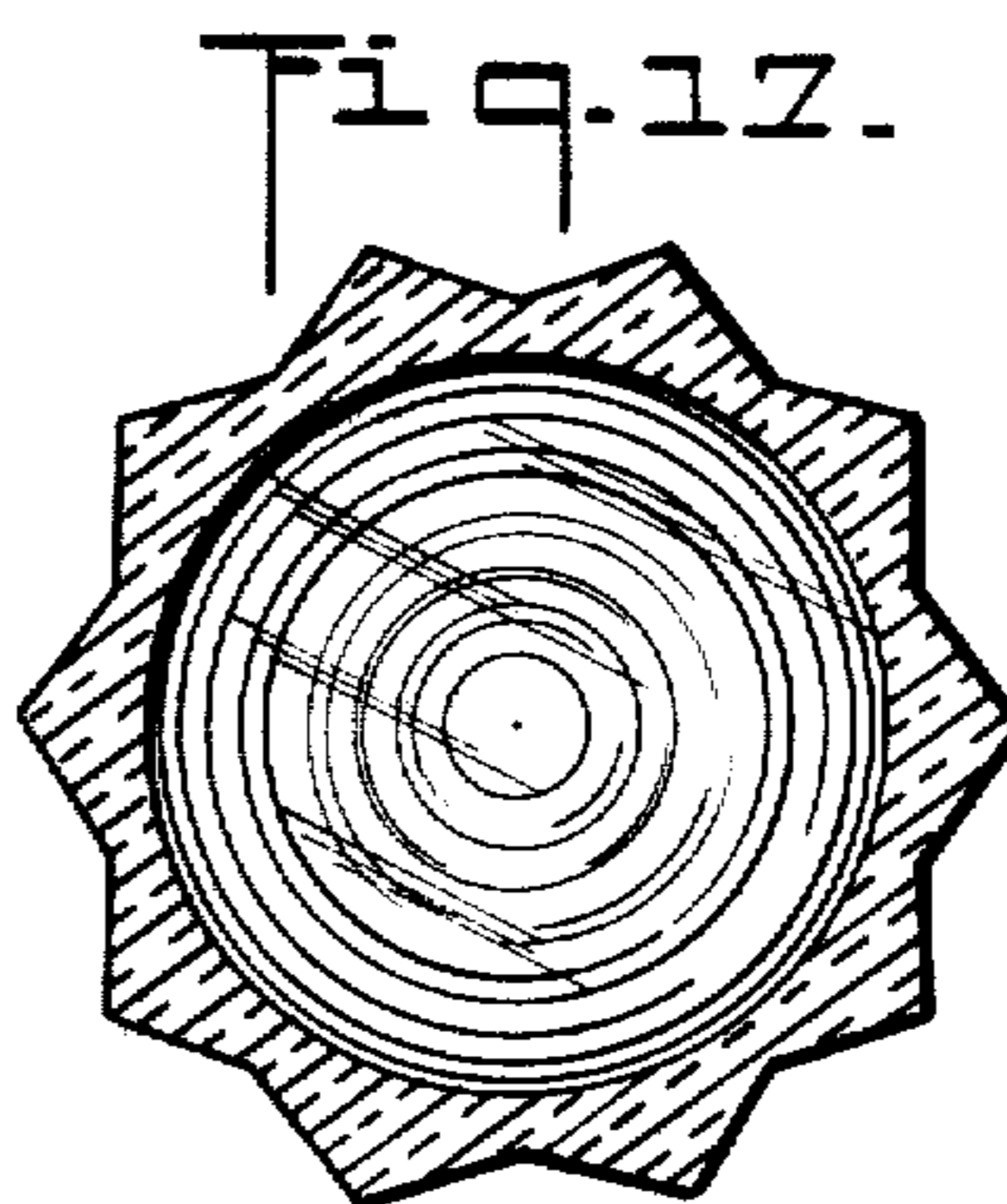
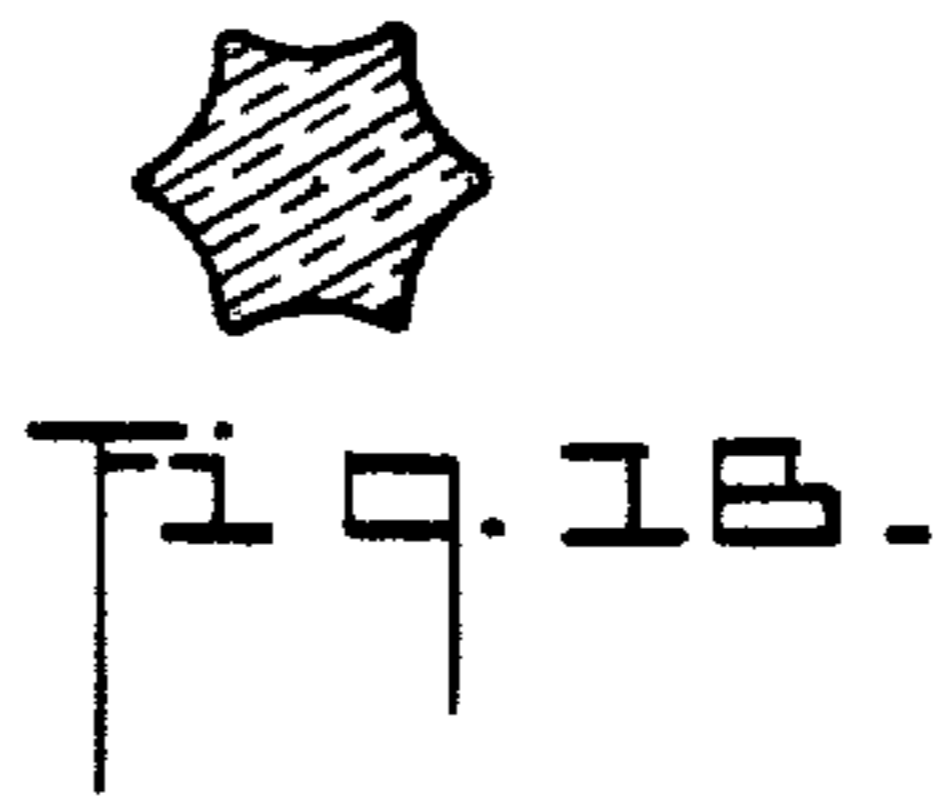

Fig. 17.

Fig. 16.

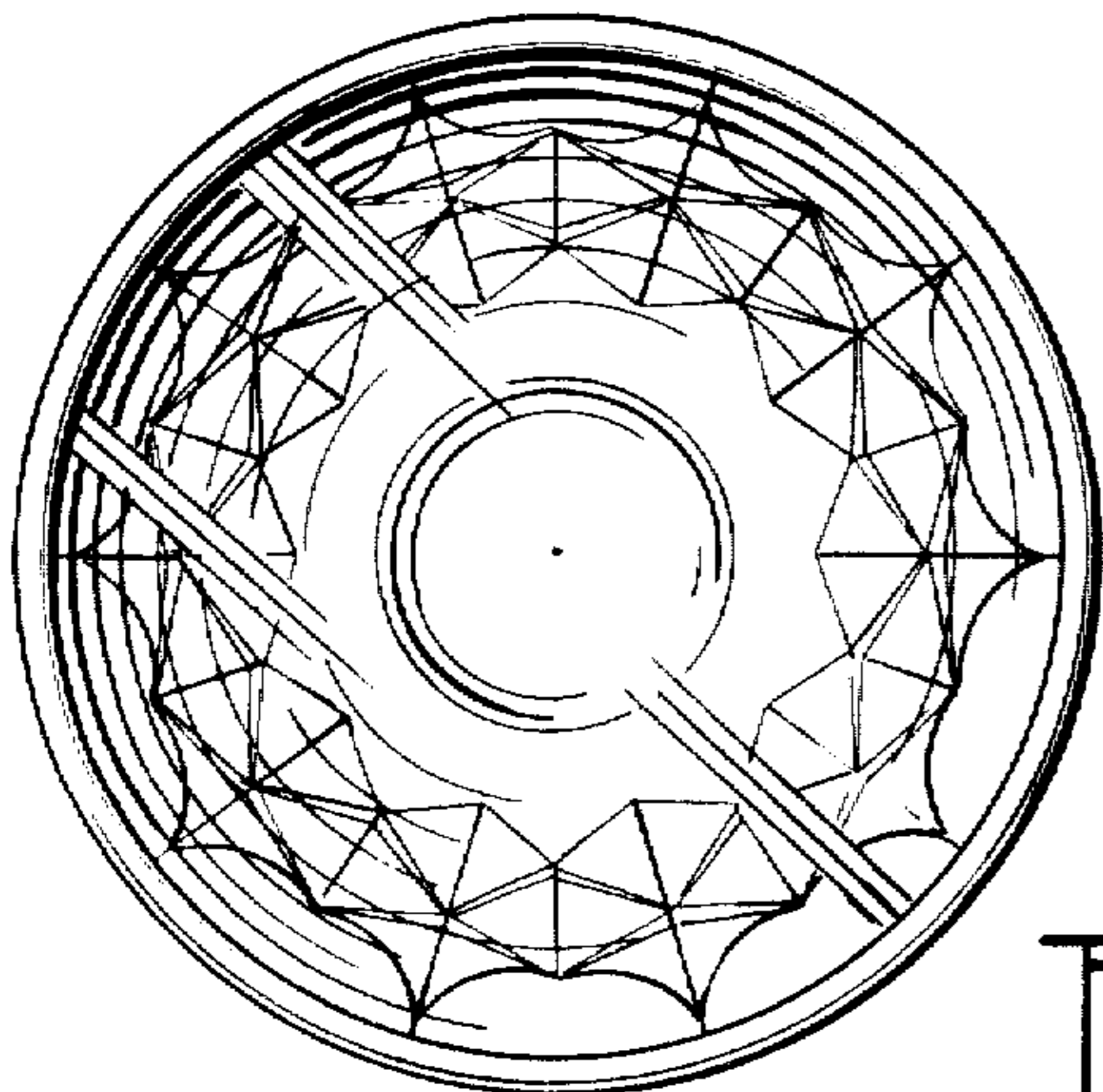

Fig. 14.

