

[54] **DESK OR SIMILAR ARTICLE**  
[75] Inventor: **Warren Platner, Guilford, Conn.**  
[73] Assignee: **Litton Business Systems, Inc., Burlington, Iowa**  
[\*\*] Term: **14 Years**  
[21] Appl. No.: **223,682**  
[22] Filed: **Jan. 9, 1981**

**Related U.S. Application Data**

[62] Division of Ser. No. 914,285, Jun. 9, 1978.  
[51] Int. Cl. .... **D06—04**  
[52] U.S. Cl. .... **D6/162**  
[58] Field of Search ..... **D6/160-181**

**References Cited**

**U.S. PATENT DOCUMENTS**

D. 169,375 4/1953 Knoll ..... D6/162  
D. 192,009 1/1962 Deaton ..... D6/162  
D. 223,046 2/1972 Nance ..... D6/162

4,258,963 3/1981 Fusselman et al. .... D6/162 X

**OTHER PUBLICATIONS**

Interiors, 1/76, p. 92, Desk, bottom left.  
Interiors, 1/76, p. 93, Desk, left center.  
*Primary Examiner*—Bruce W. Dunkins  
*Attorney, Agent, or Firm*—Michael H. Wallach; Robert F. Rotella

**CLAIM**

The ornamental design for a desk or similar article, as shown and described.

**DESCRIPTION**

FIG. 1 is a front elevational view of the invention, the article shown being a desk or similar article.  
FIG. 2 is a top plan view;  
FIG. 3 is a left side elevational view;  
FIG. 4 is a rear elevational view;  
FIG. 5 is a right side elevational view;  
FIG. 6 is a bottom plan view; and  
FIG. 7 is an enlarged, detail sectional view taken on line 7—7 of FIG. 5.

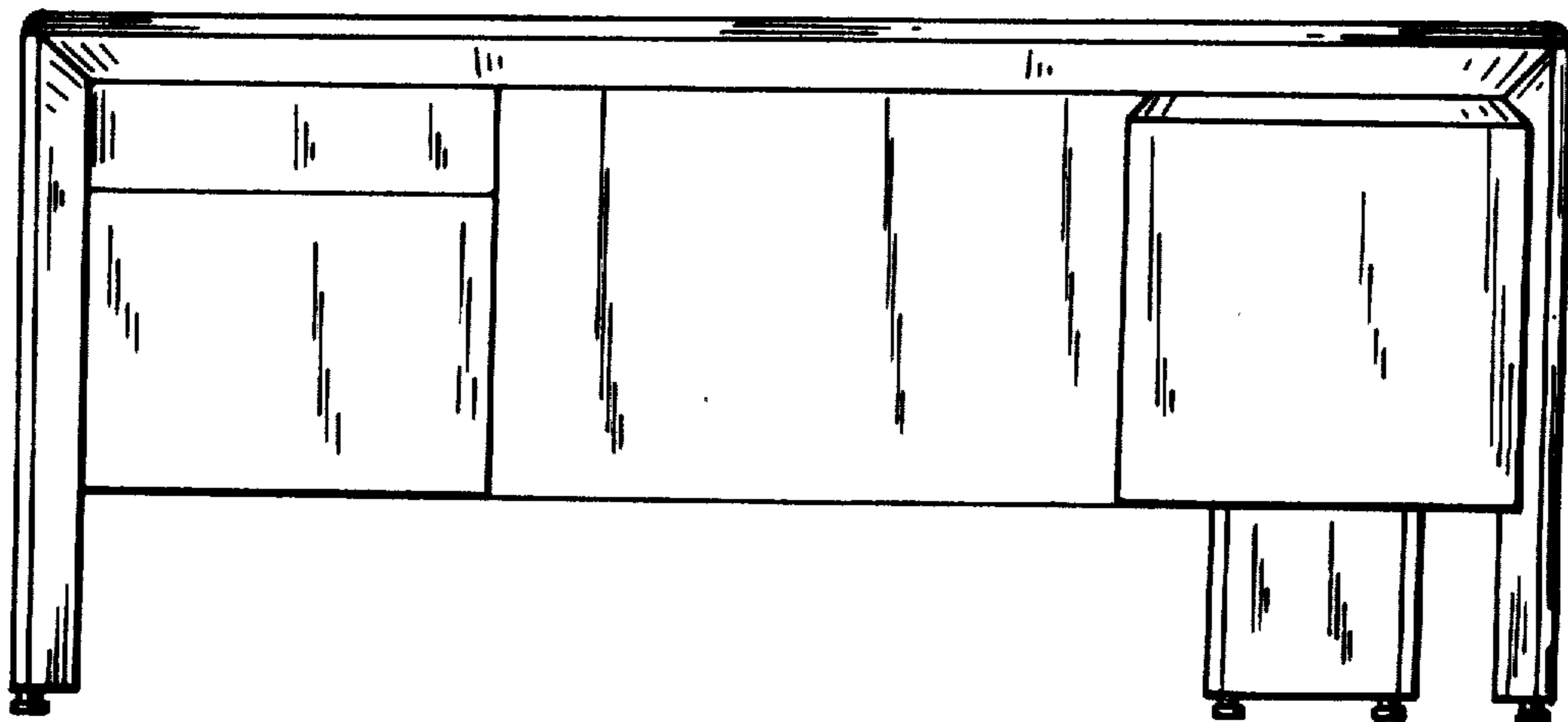

FIG. 1

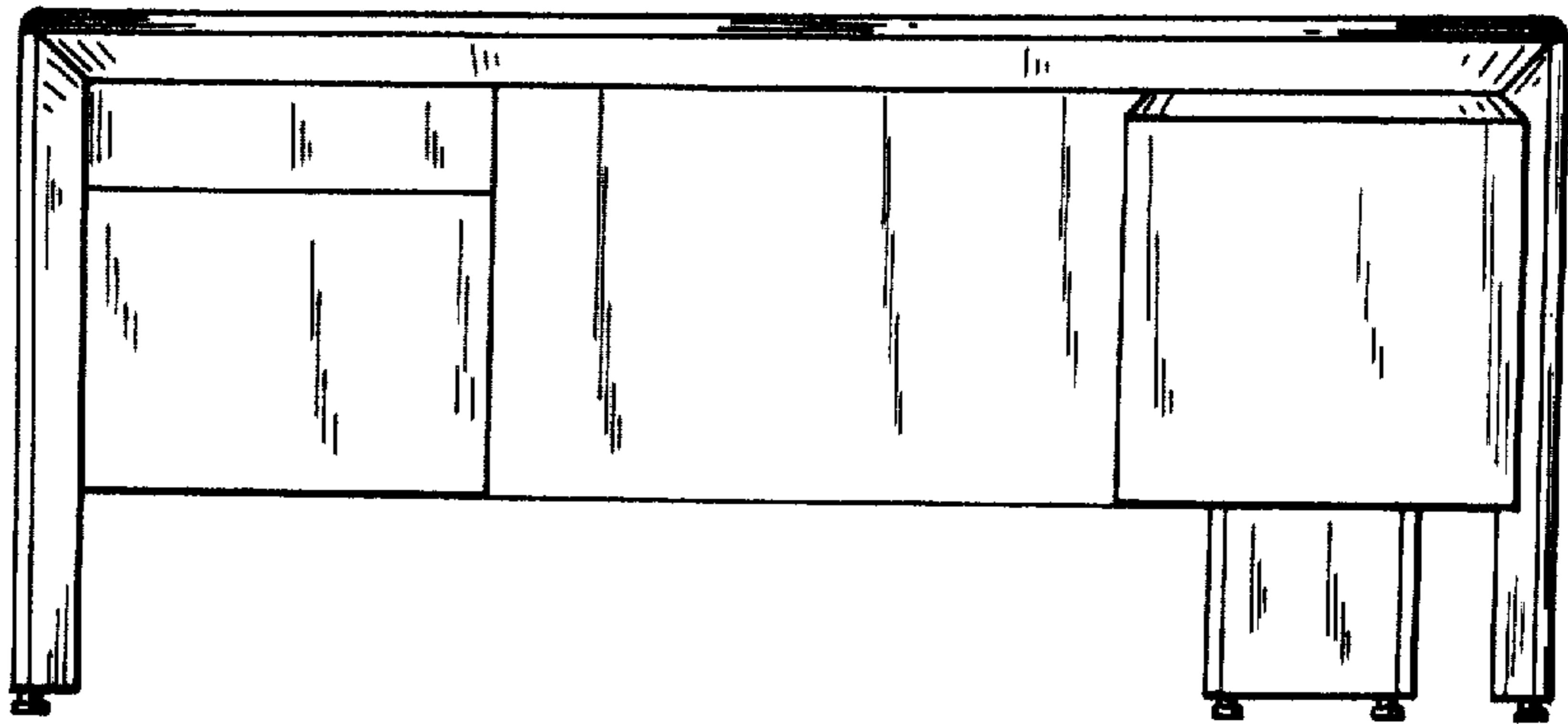

FIG. 2

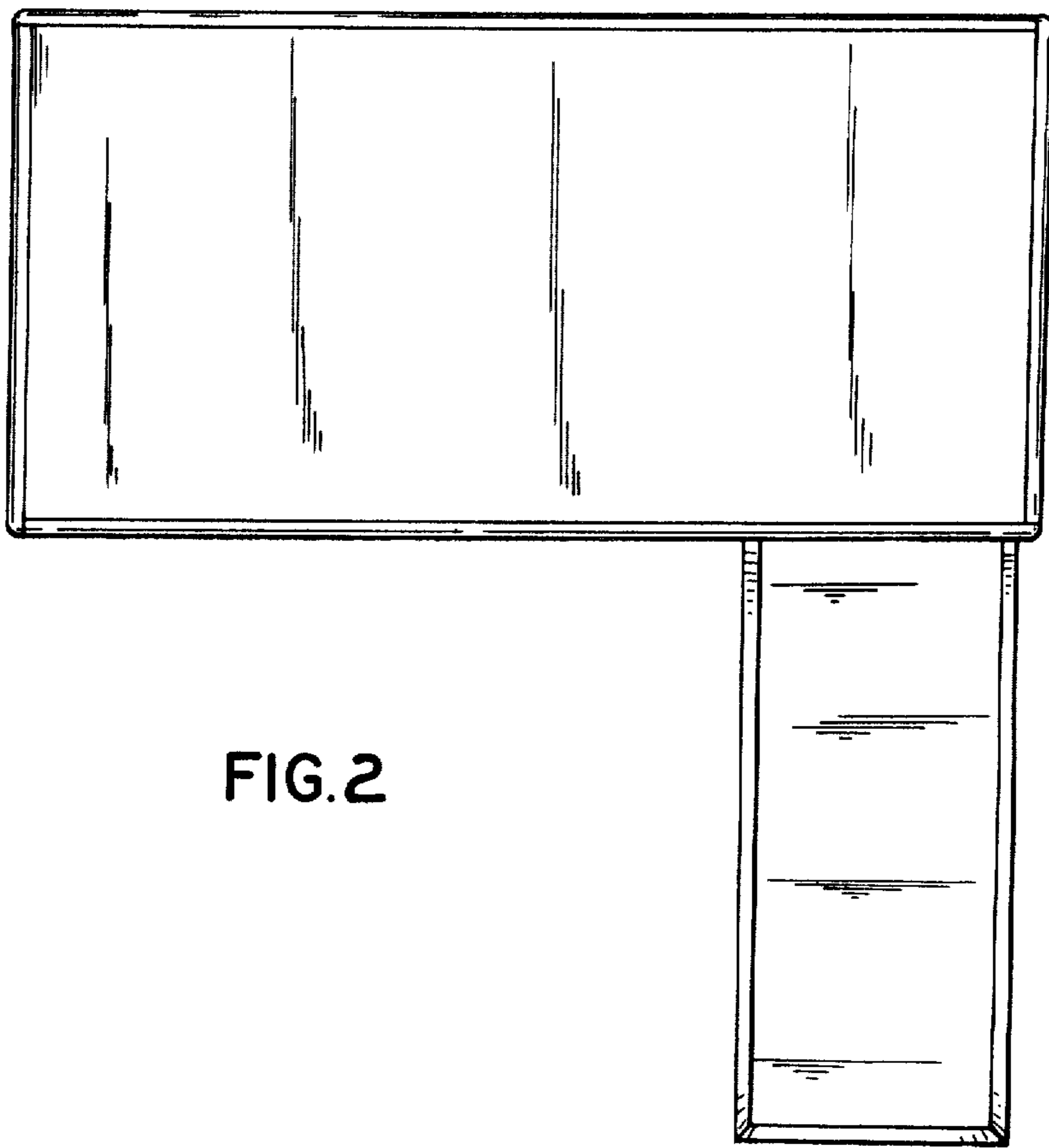

FIG. 3

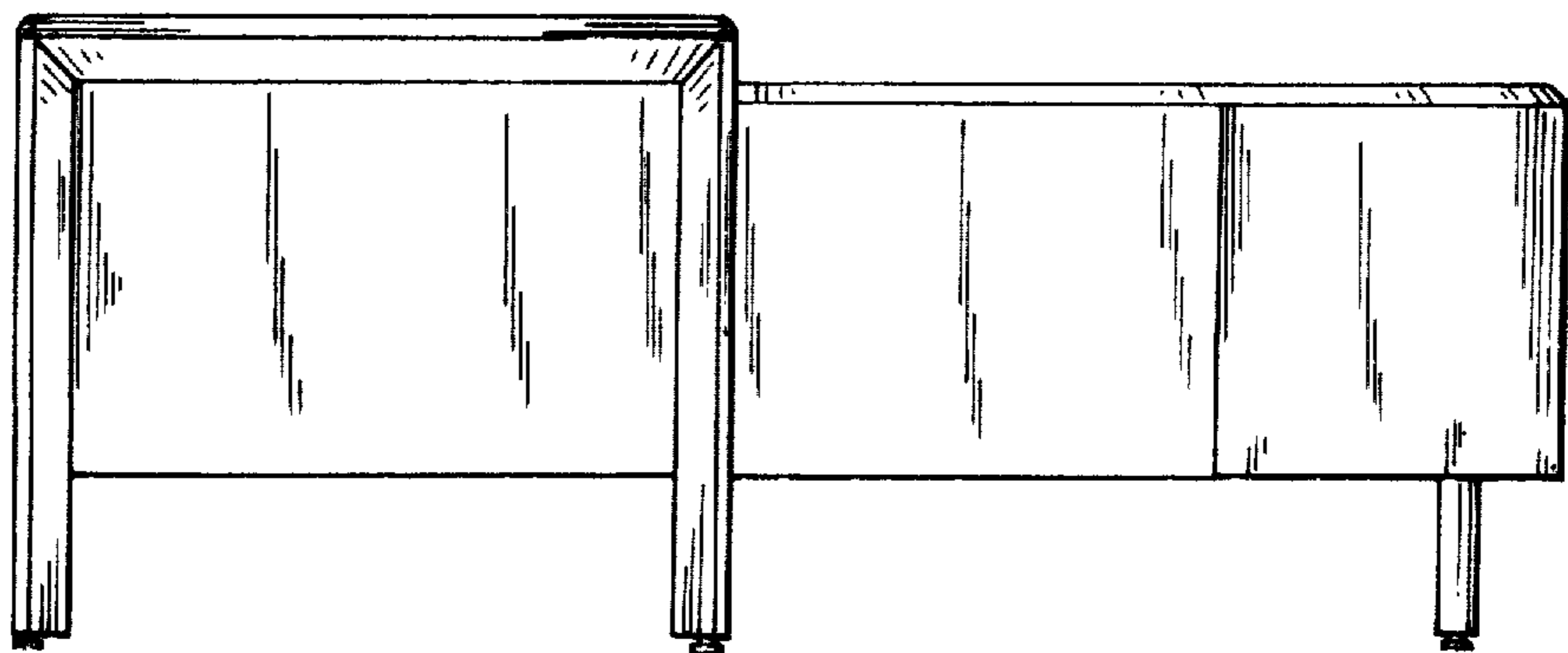

FIG. 4

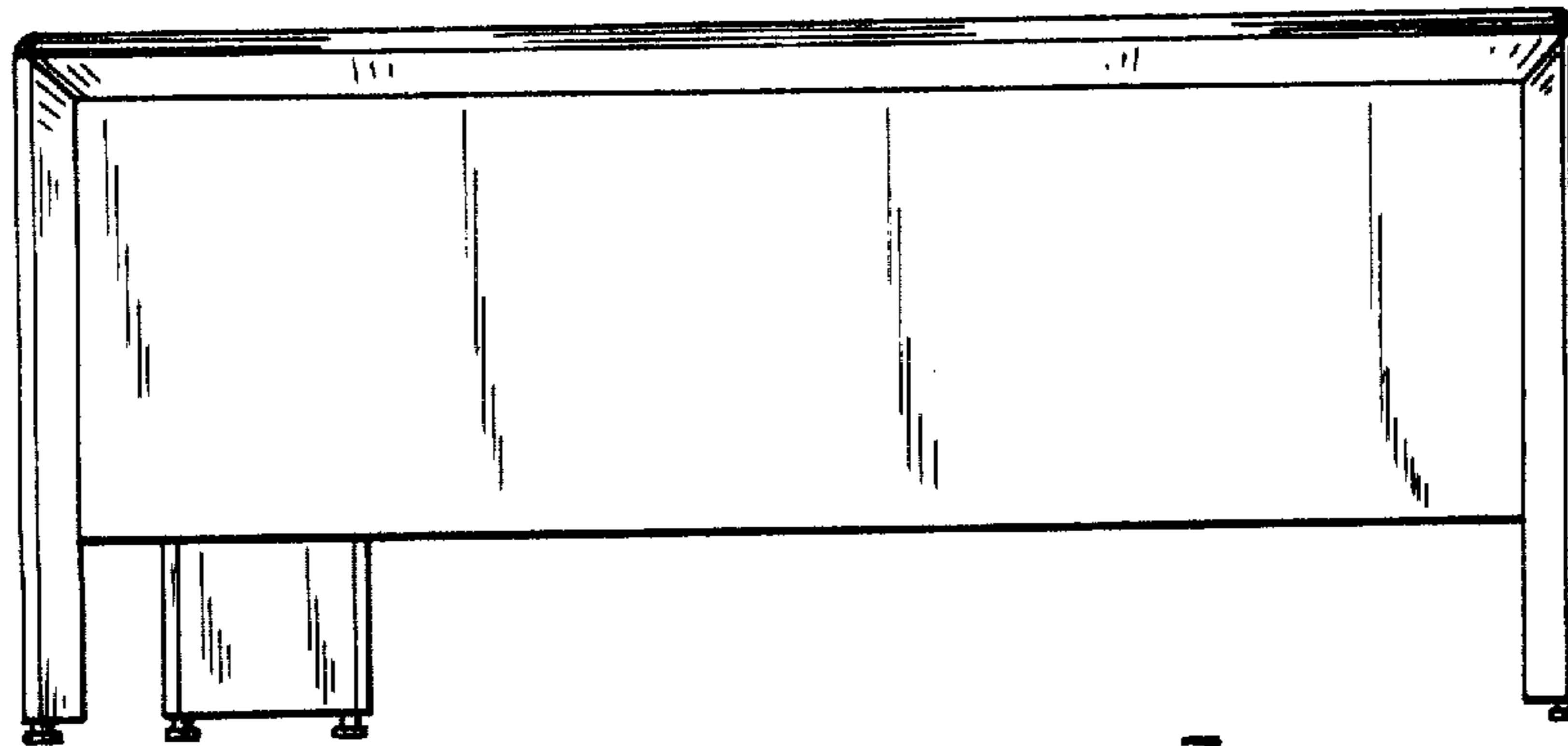

FIG. 5

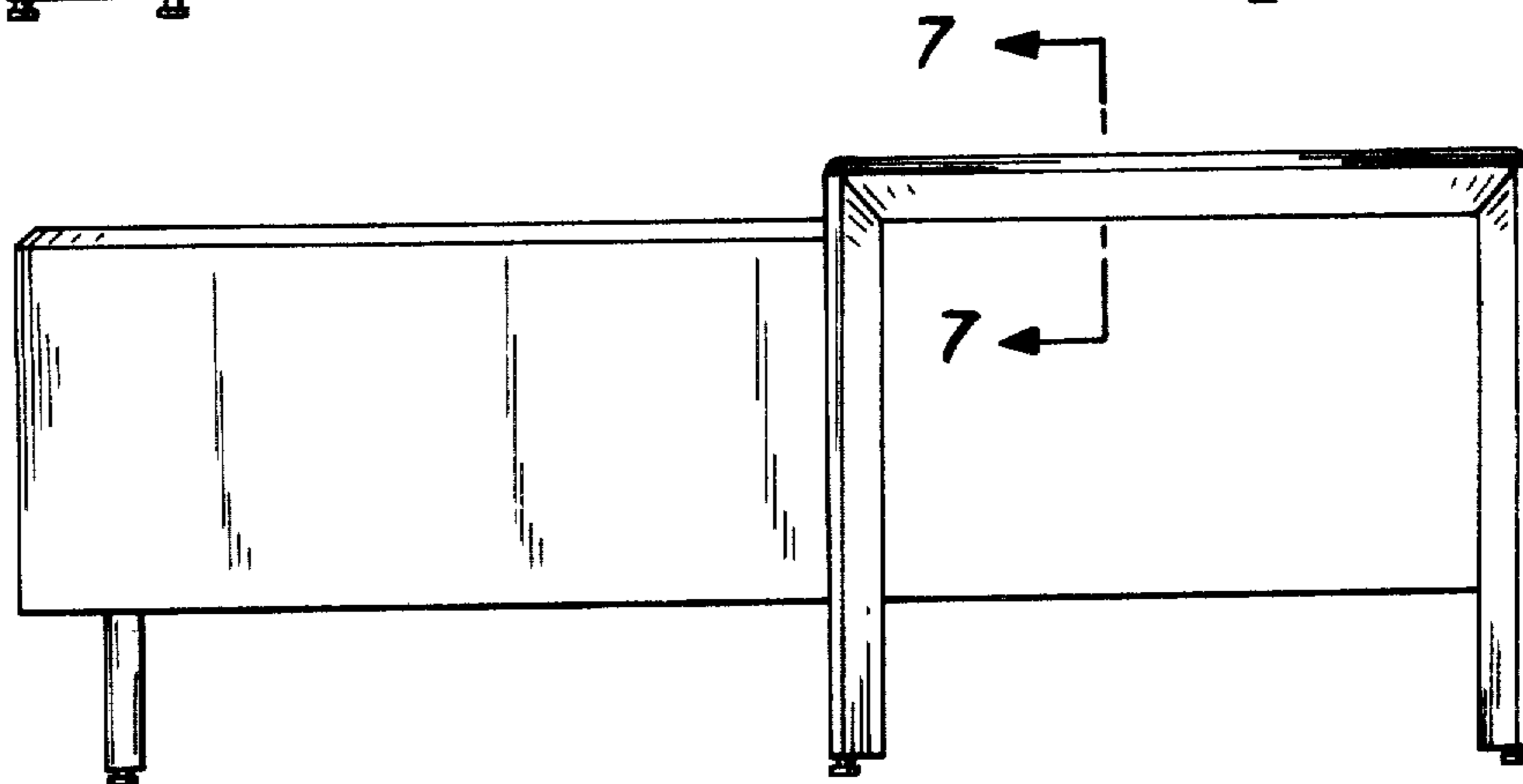

FIG. 7

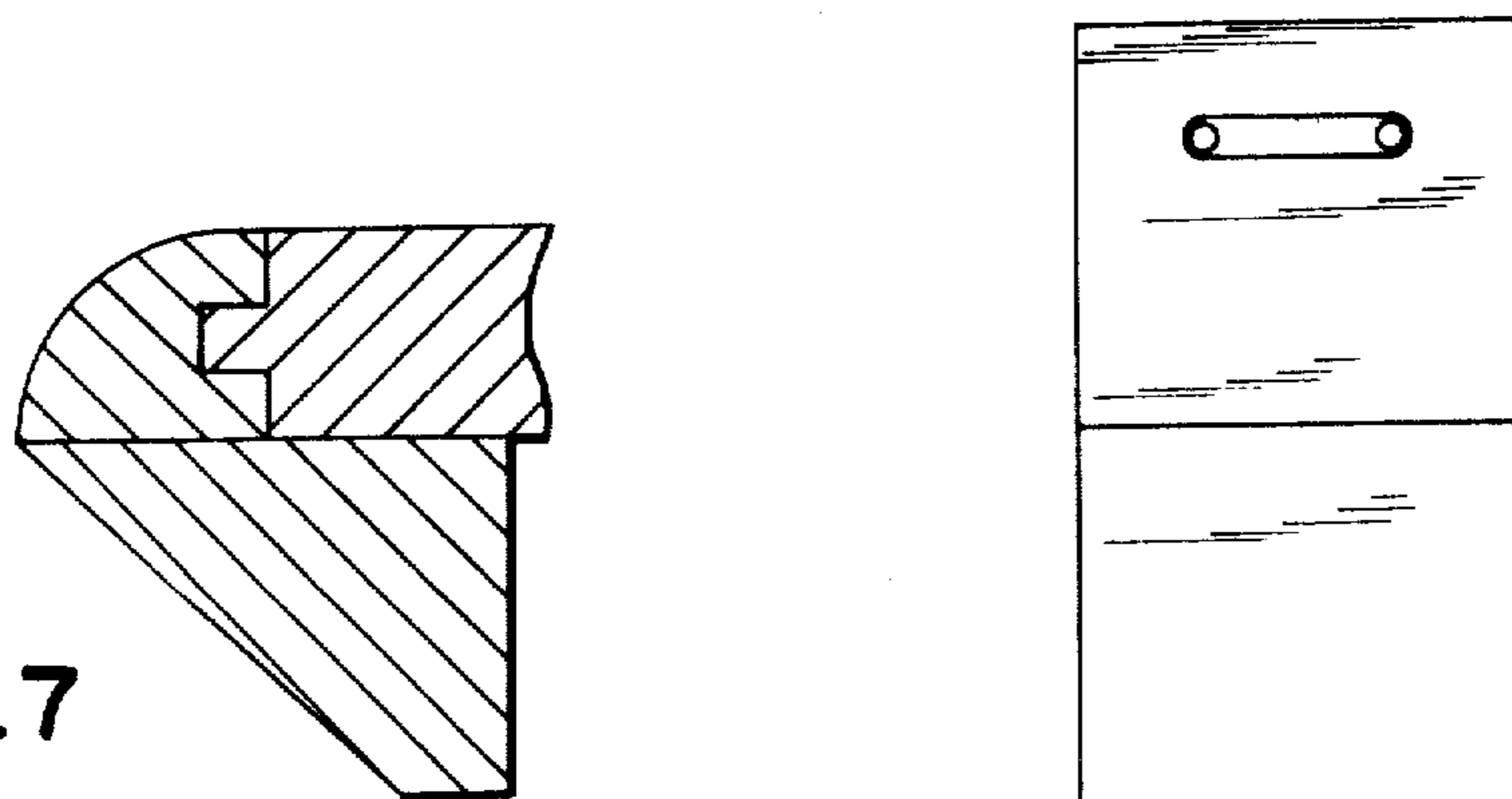

FIG. 6

