

[54] **COFFEE TABLE**

[75] **Inventor:** Larry G. Hickey, Costa Mesa, Calif.

[73] **Assignee:** Tropitone Furniture Co., Inc.,
Sarasota, Fla.

[**] **Term:** 14 Years

[21] **Appl. No.:** 223,488

[22] **Filed:** Dec. 23, 1980

[51] **Int. Cl.** D6-03

[52] **U.S. Cl.** D6/175

[58] **Field of Search** D6/20, 27, 146-149,
D6/175, 177-179, 144

[56] **References Cited**

U.S. PATENT DOCUMENTS

D. 252,902 9/1979 Ungard D6/175
D. 258,177 2/1981 Baker D6/144

OTHER PUBLICATIONS

Thinline Cat. p. 29, Table No. 2800-24.
Selig Import Cat., p. D13, Ottoman.

Primary Examiner—Bruce W. Dunkins
Attorney, Agent, or Firm—Nathaniel A. Humphries

[57] **CLAIM**

The ornamental design for a coffee table, substantially as shown and described.

DESCRIPTION

FIG. 1 is a perspective view of a coffee table embodying my inventive design;
FIG. 2 is a top plan view thereof;
FIG. 3 is a front elevation view thereof with it being understood that a rear elevation view would be identical thereto;
FIG. 4 is an end elevation view thereof;
FIG. 5 is a bottom plan view thereof;
FIG. 6 is a sectional view taken along lines 6-6 of FIG. 3;
FIG. 7 is a top plan view of an alternate embodiment in which the length dimension is reduced as compared to the first embodiment with remaining design details being identical; and
FIG. 8 is a front elevation view of the embodiment of FIG. 7 which would be identical to a rear elevation view thereof.

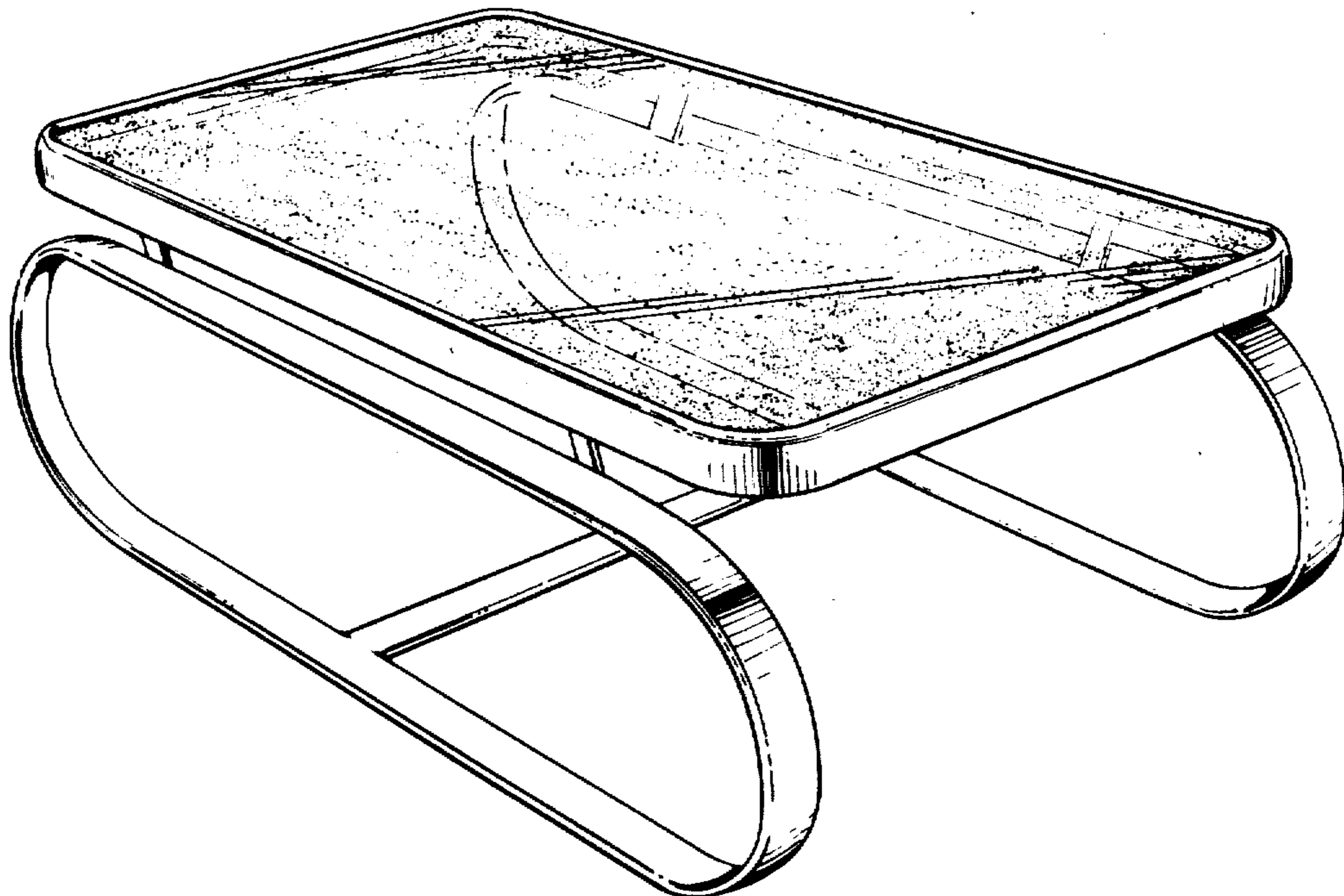

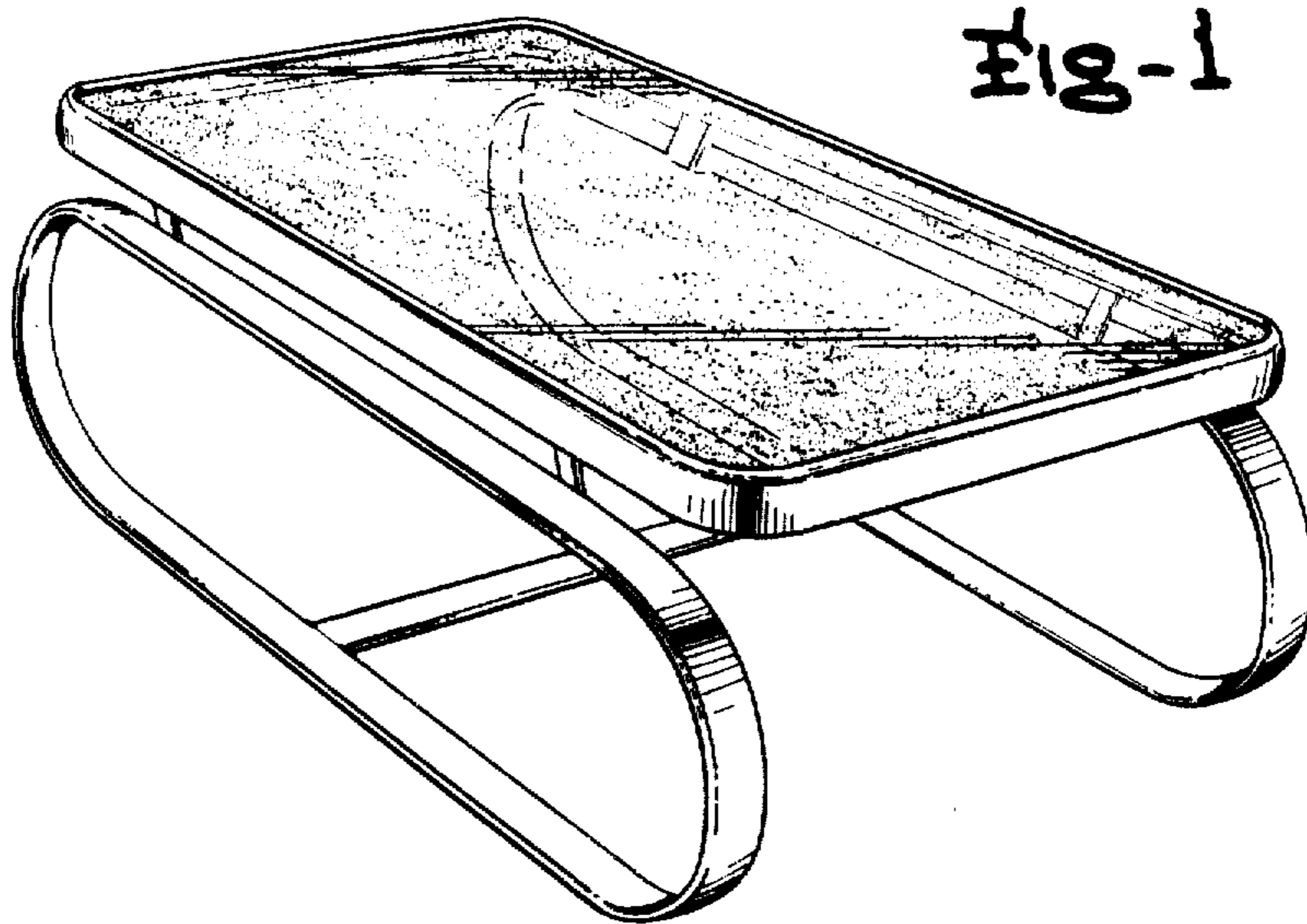

Fig-2

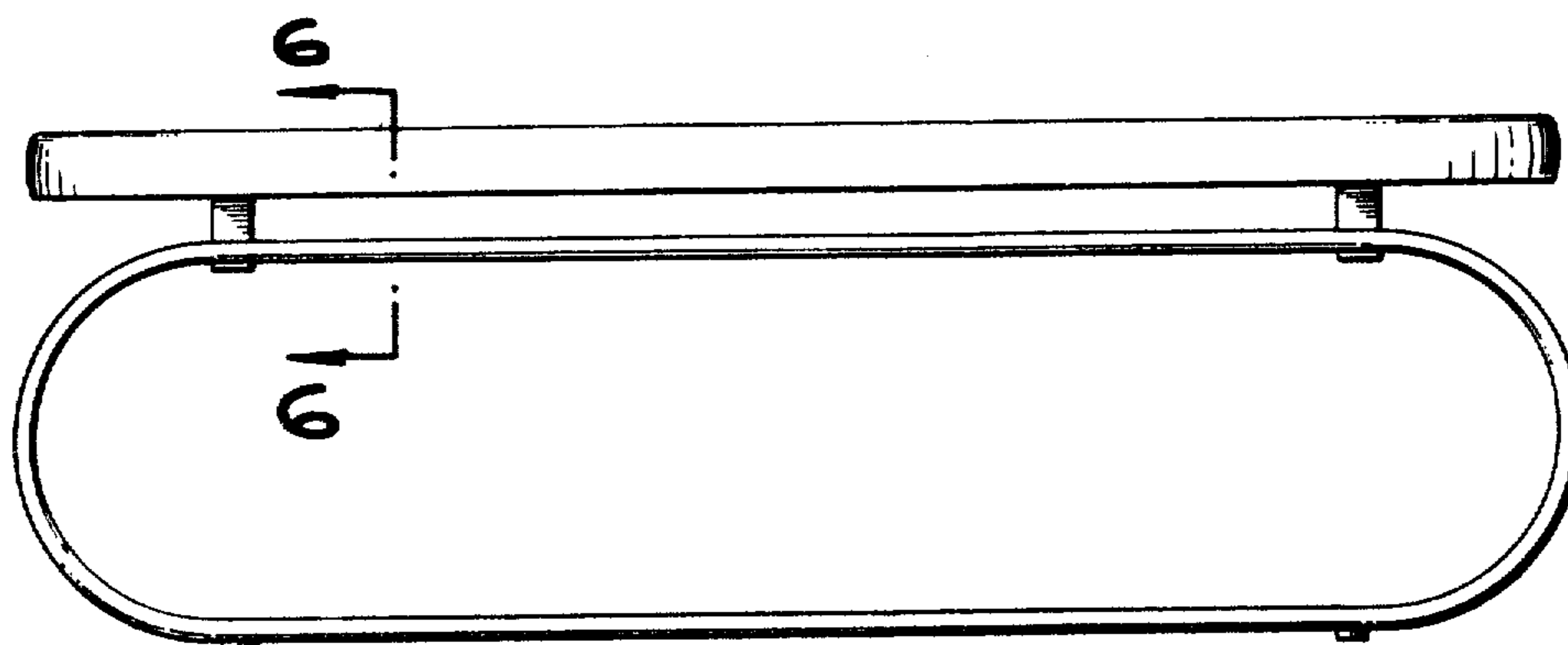
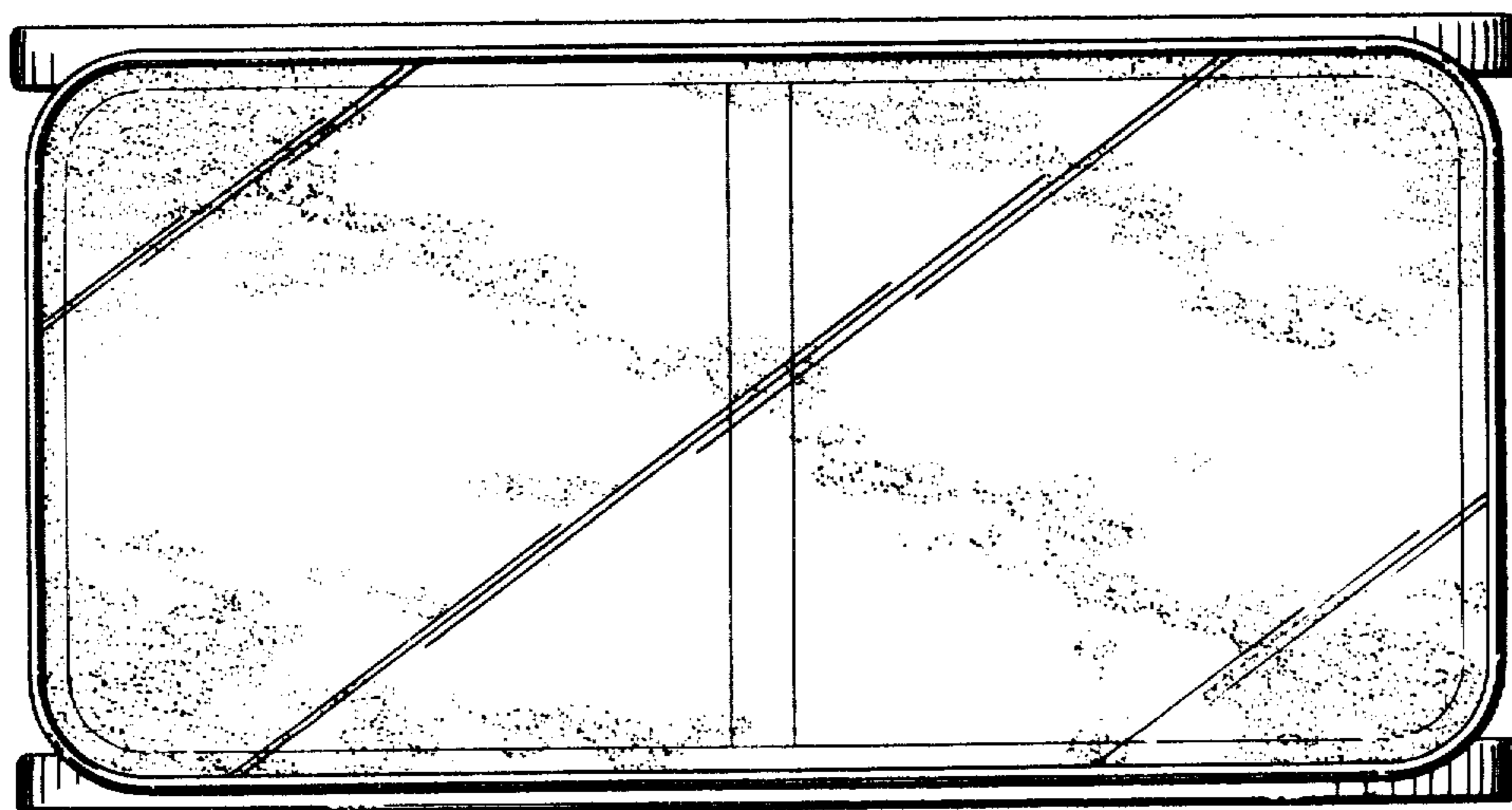

Fig-4

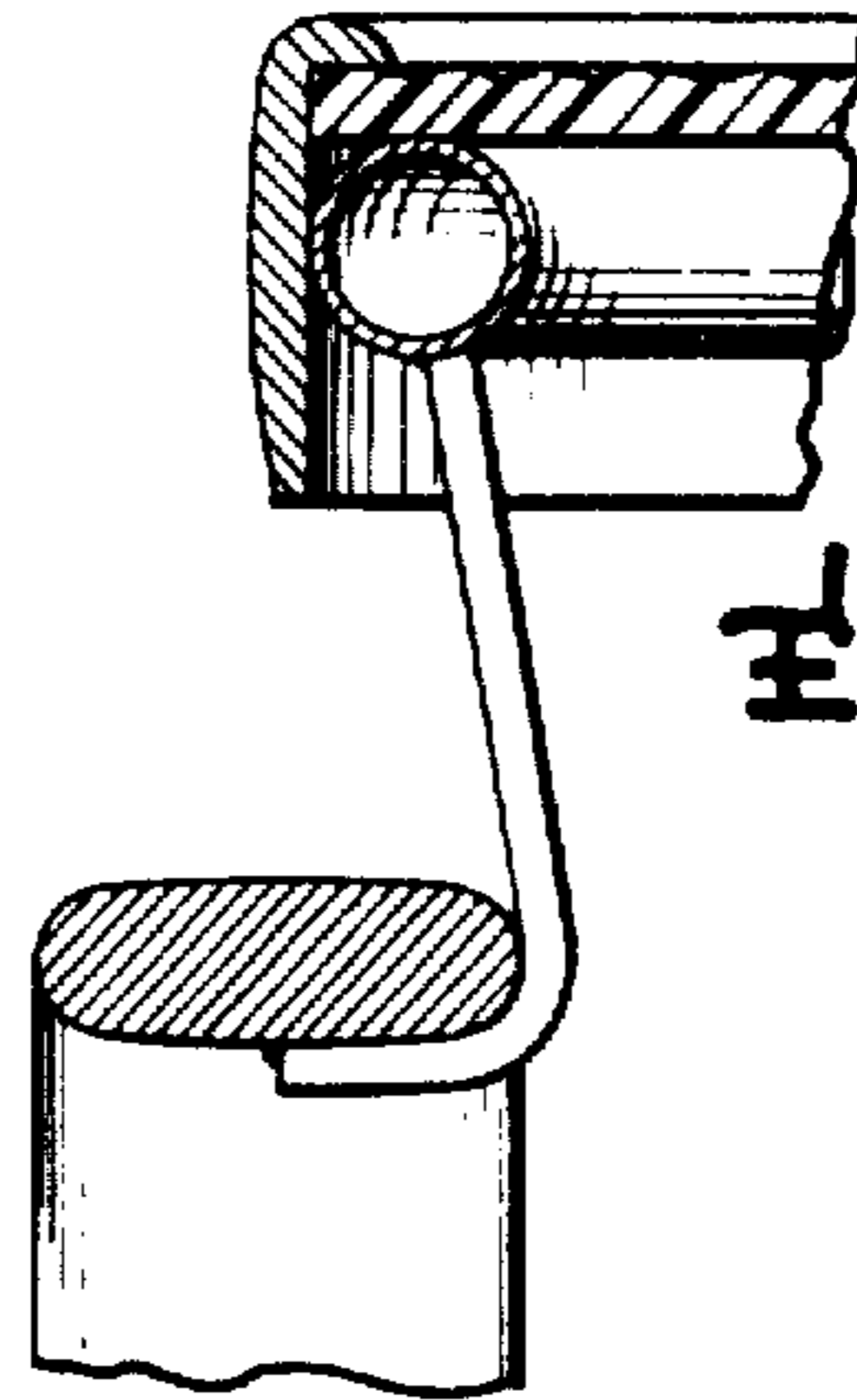
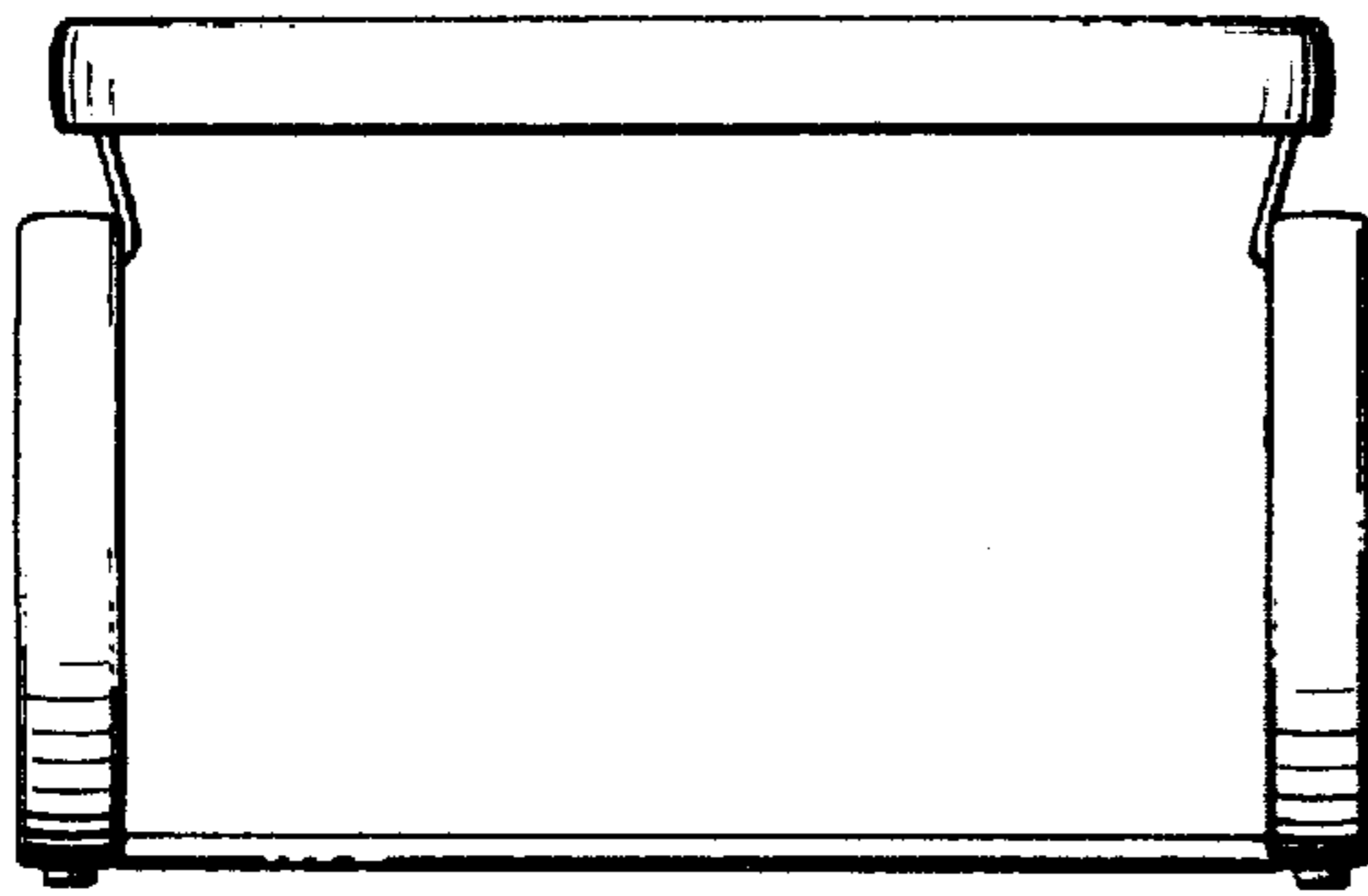

Fig-6

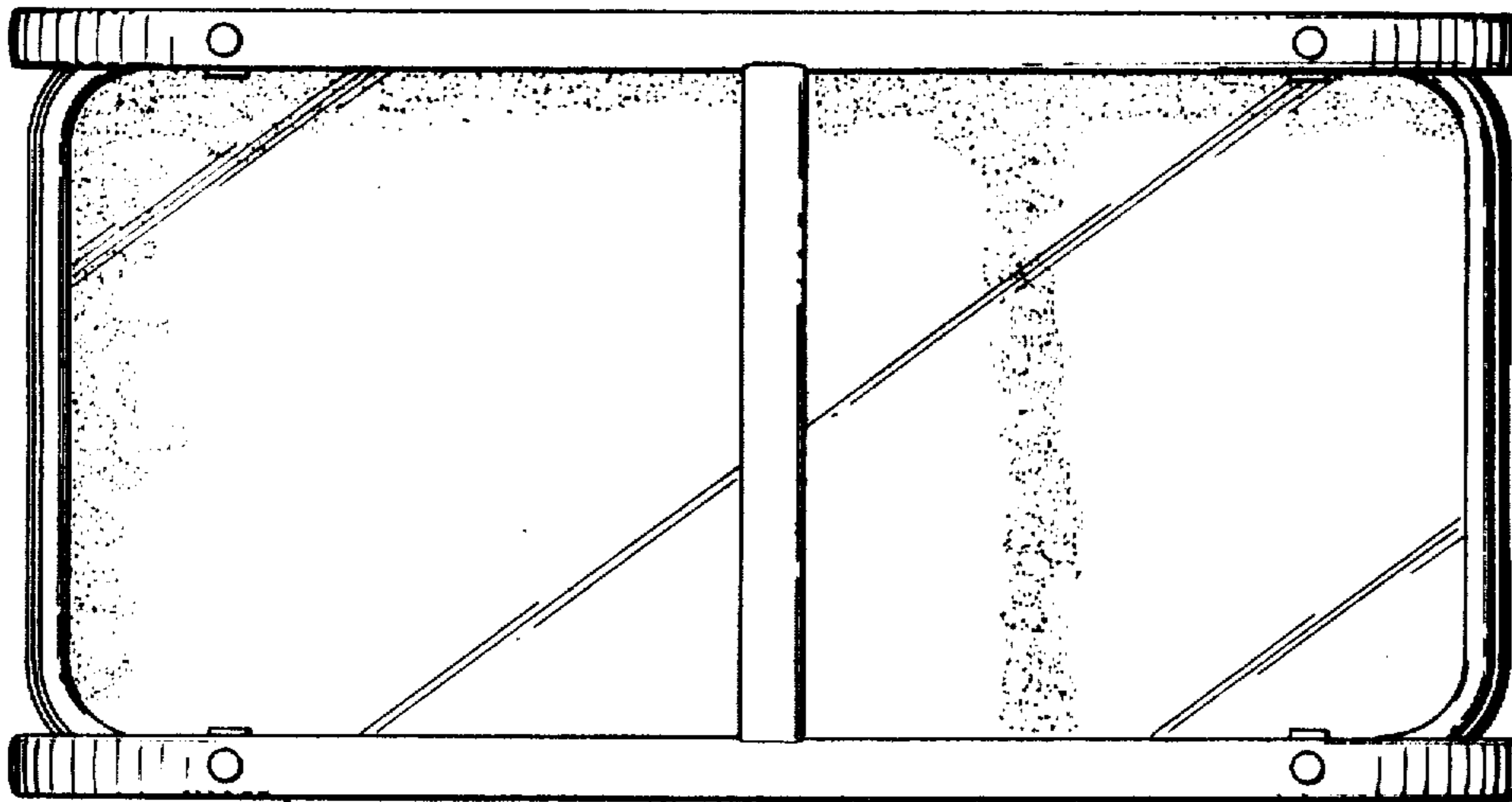

Fig-5

Fig-7

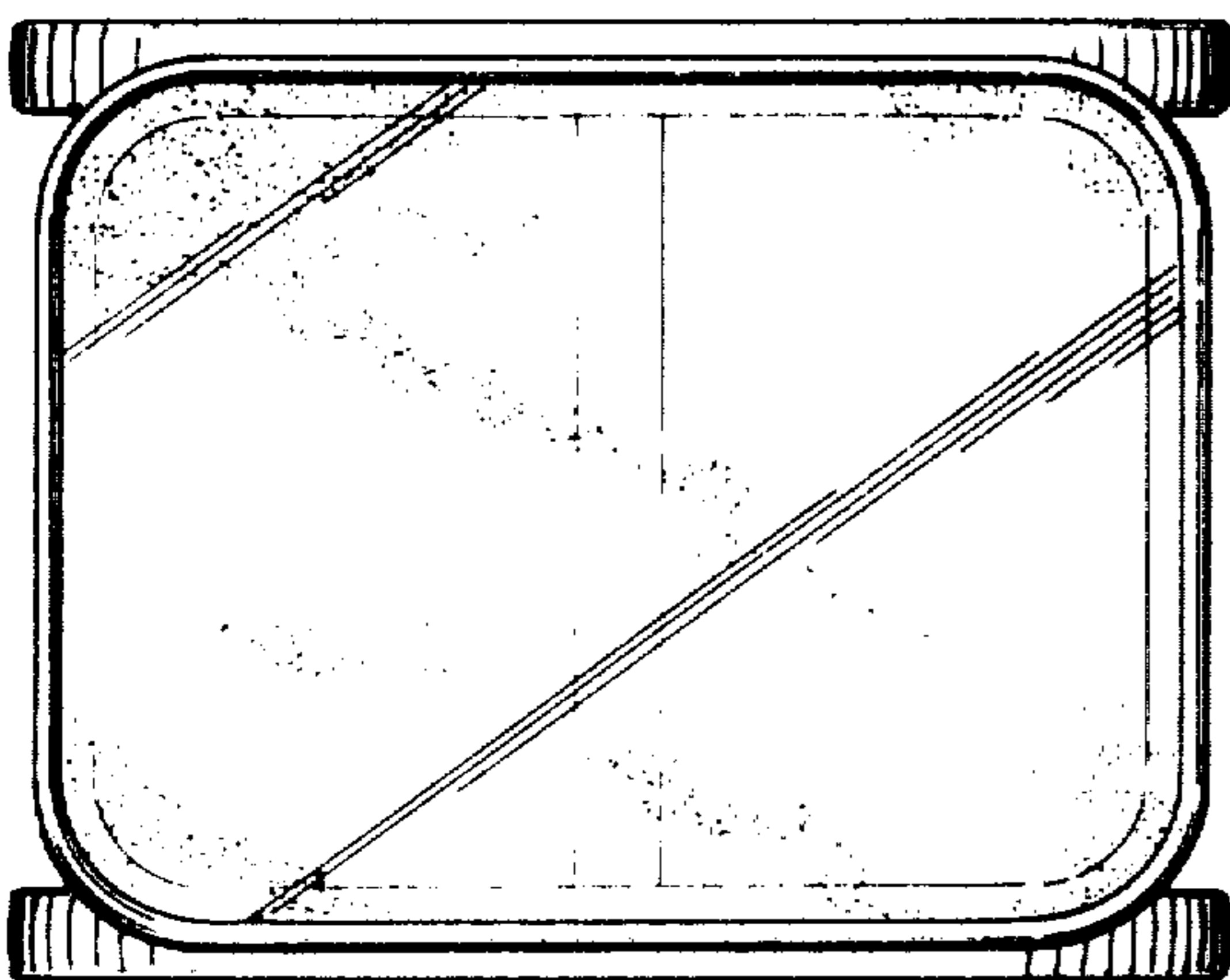

Fig-8

