

[54] TELEPHONE

[75] Inventors: Lonnie Daharsh, Dallas; George W. Eggers, Garland, both of Tex.

[73] Assignee: Tel-Com Manufacturing, Inc., Dallas, Tex.

[\*\*] Term: 14 Years

[21] Appl. No.: 261,604

[22] Filed: May 7, 1981

[51] Int. Cl. .... D14-03

[52] U.S. Cl. .... D14/53; D21/111

[58] Field of Search ..... D14/60, 53, 69; D25/7; 179/103, 178, 179, 100 R, 100 D; D7/9; D11/157; D2/232, 231; D21/111; D9/307, 328

[56] References Cited

U.S. PATENT DOCUMENTS

|            |         |                      |             |
|------------|---------|----------------------|-------------|
| D. 212,582 | 11/1968 | Feldmann et al. .... | D2/231      |
| D. 216,988 | 3/1970  | Je Rue et al. ....   | D2/232      |
| D. 246,469 | 11/1977 | Morton et al. ....   | D25/7       |
| D. 248,556 | 7/1978  | Thomas ....          | D11/157 X   |
| D. 248,651 | 7/1978  | Zivica ....          | D14/69      |
| D. 260,260 | 8/1981  | Thomas ....          | 179/100 D X |
| 4,087,650  | 5/1978  | Tucker ....          | 179/100 D   |

Primary Examiner—Bernard Ansher  
Attorney, Agent, or Firm—Stanley R. Moore; Thomas L. Crisman

[57] CLAIM

The ornamental design for a telephone, as shown and described.

DESCRIPTION

FIG. 1 is a rear perspective view of a telephone showing our new design;  
 FIG. 2 is a front elevation thereof;  
 FIG. 3 is a rear elevation thereof;  
 FIG. 4 is a side elevation thereof;  
 FIG. 5 is a top plan view thereof;  
 FIG. 6 is a bottom plan view thereof;  
 FIG. 7 is a rear perspective view of a second modified embodiment of the telephone illustrated in FIG. 1;  
 FIG. 8 is a front elevation thereof;  
 FIG. 9 is a rear elevation thereof;  
 FIG. 10 is a side elevation thereof;  
 FIG. 11 is a top plan view thereof;  
 FIG. 12 is a bottom plan view thereof;  
 FIG. 13 is a rear perspective view of a third modified embodiment of the form illustrated in FIG. 1;  
 FIG. 14 is a front elevation thereof;  
 FIG. 15 is a rear elevation thereof;  
 FIG. 16 is a side elevation thereof;  
 FIG. 17 is a top plan view thereof;  
 FIG. 18 is a bottom plan view thereof;  
 FIG. 19 is a rear perspective view of a fourth modified embodiment of the form disclosed in FIG. 1;  
 FIG. 20 is a front elevation thereof;  
 FIG. 21 is a rear elevation thereof;  
 FIG. 22 is a side elevation thereof;  
 FIG. 23 is a top plan view thereof; and  
 FIG. 24 is a bottom plan view thereof.

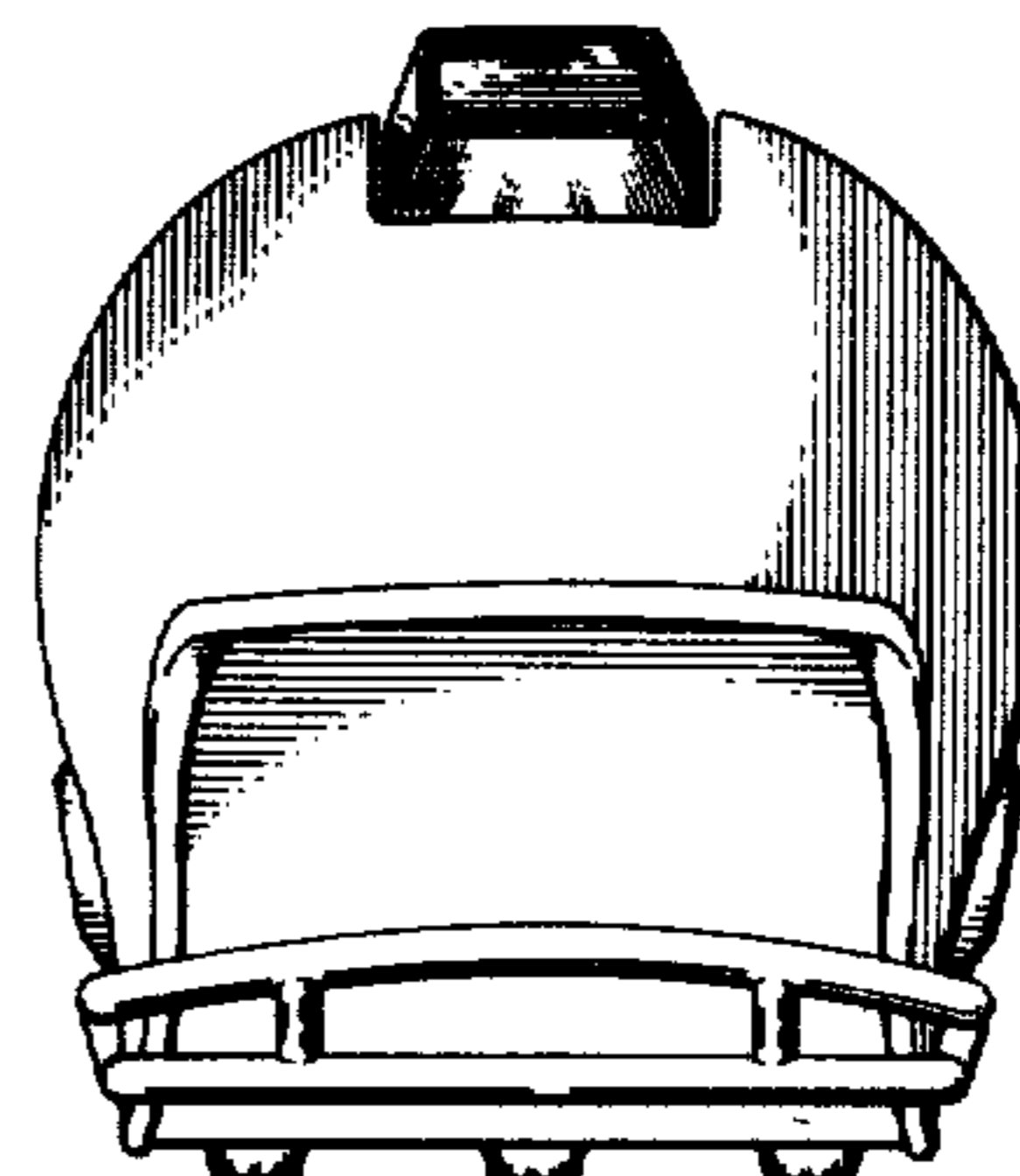
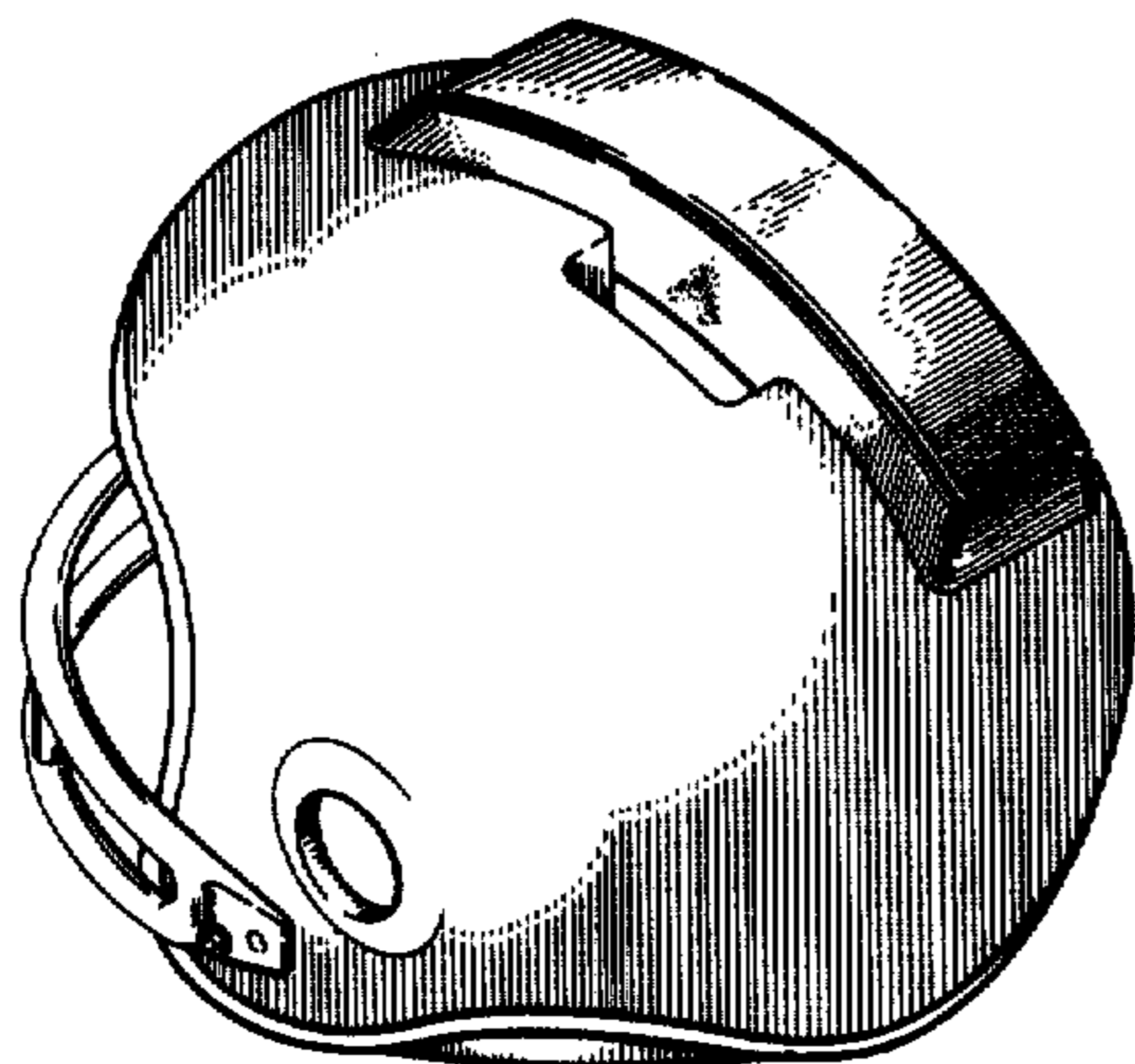

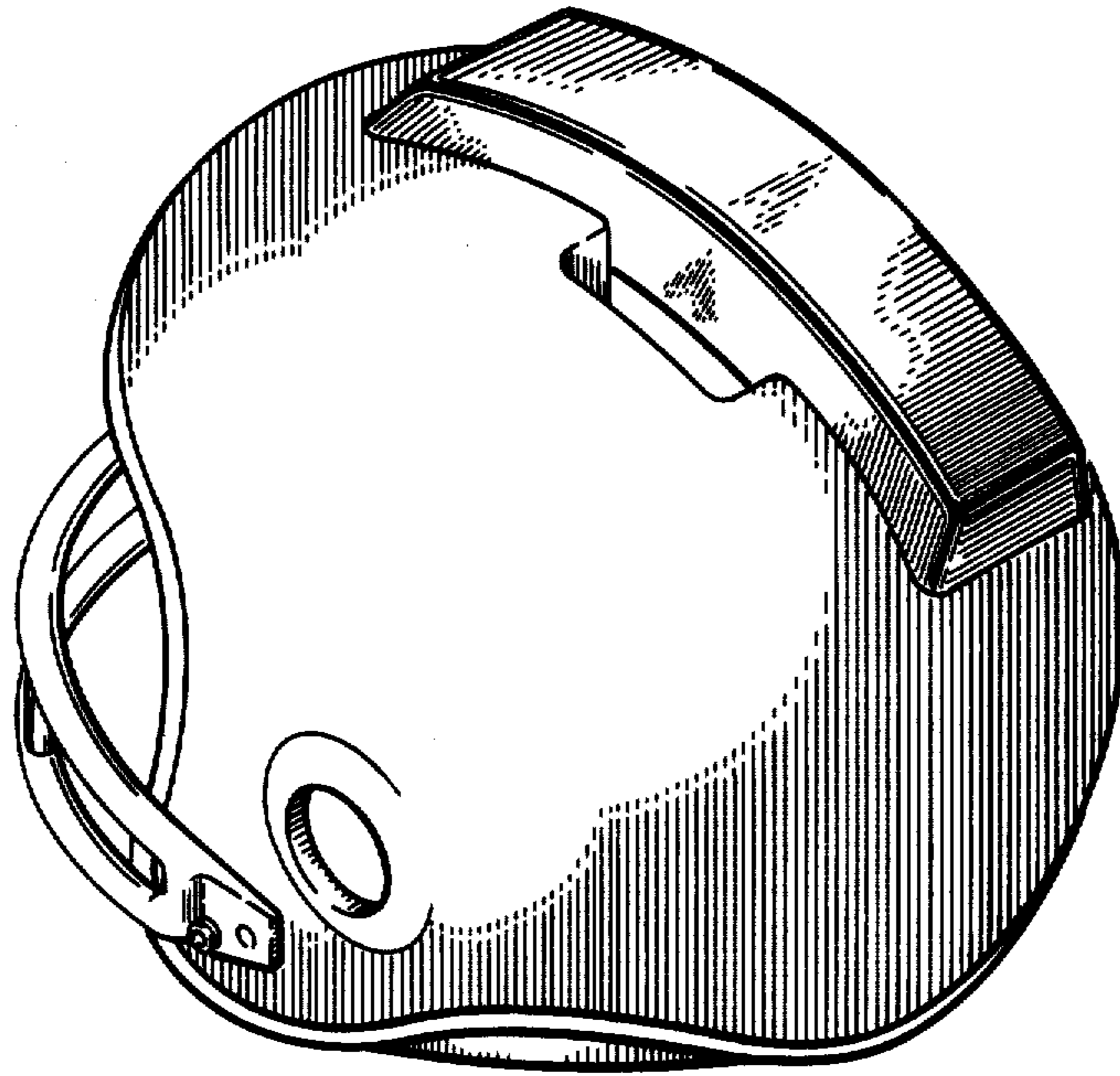

FIG. 1

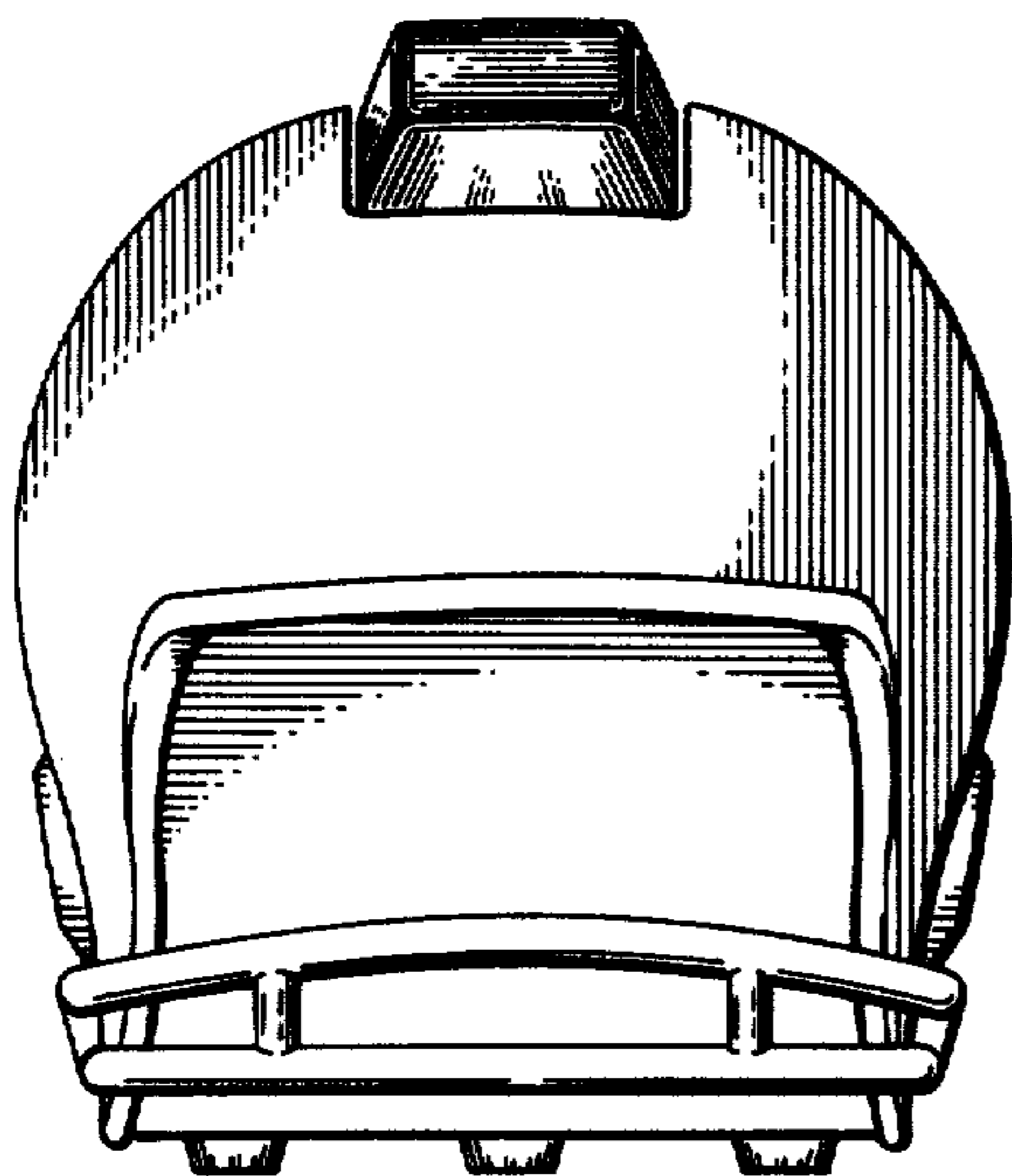

FIG. 2

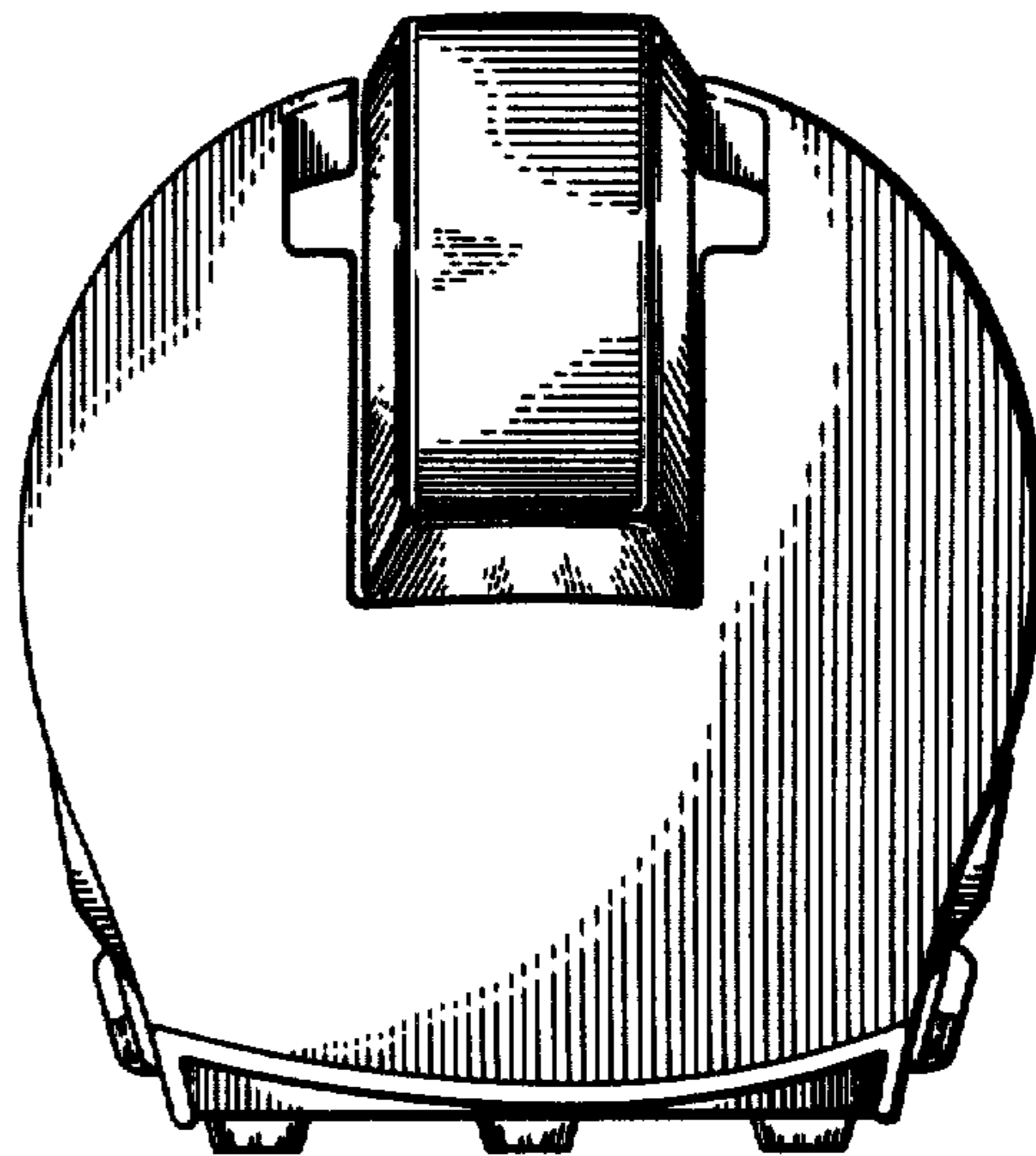

FIG. 3

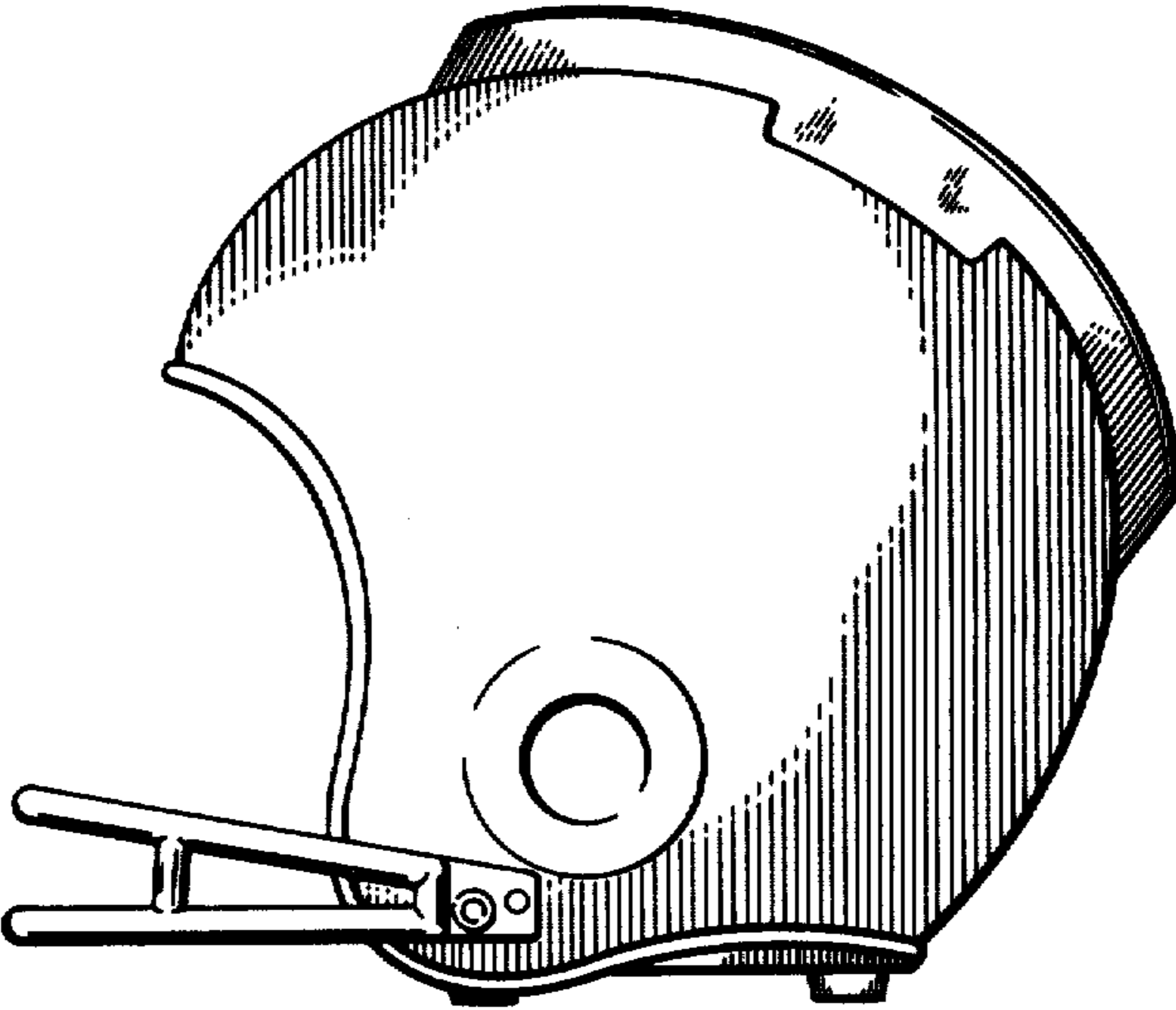

FIG. 4

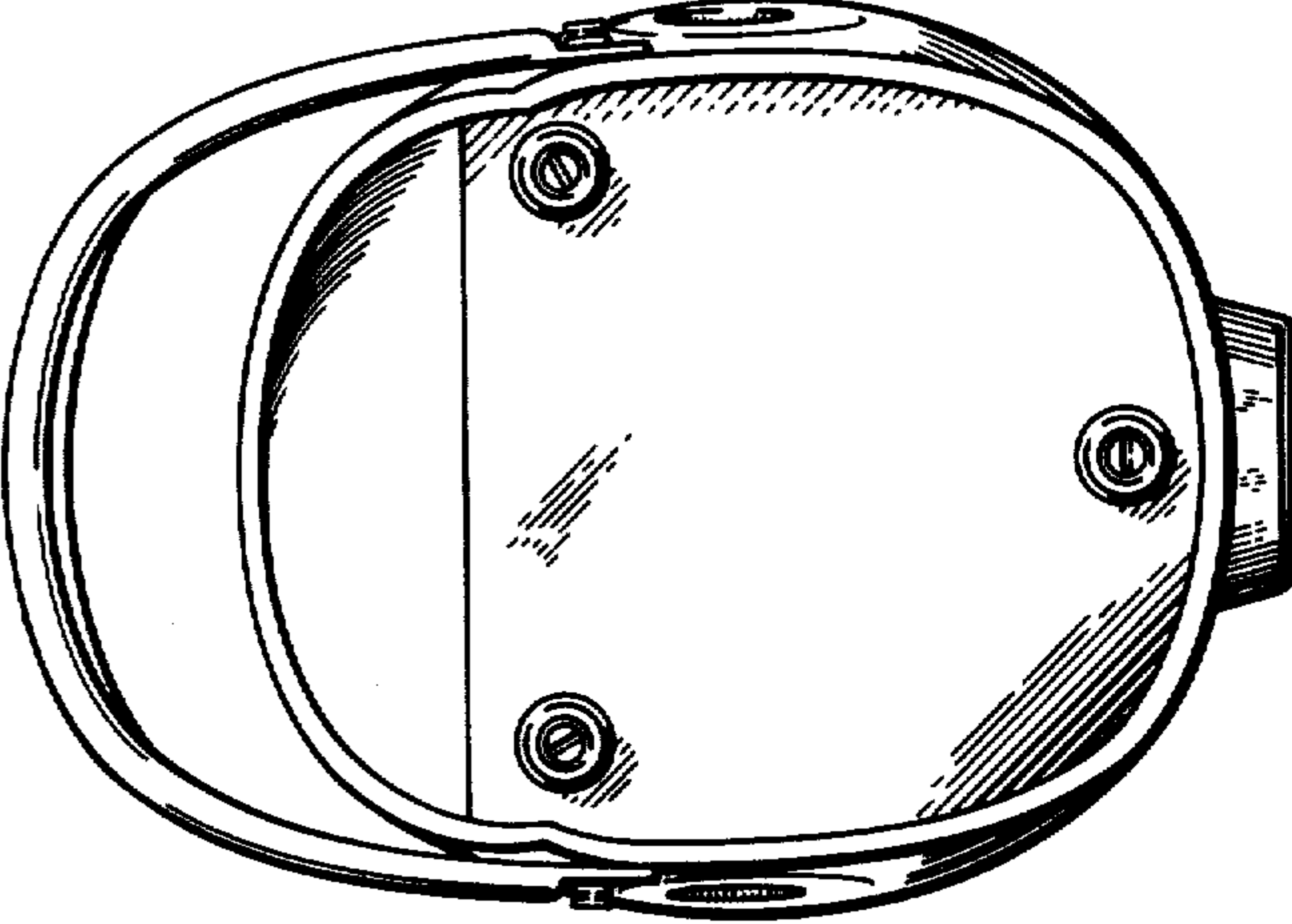

FIG. 5

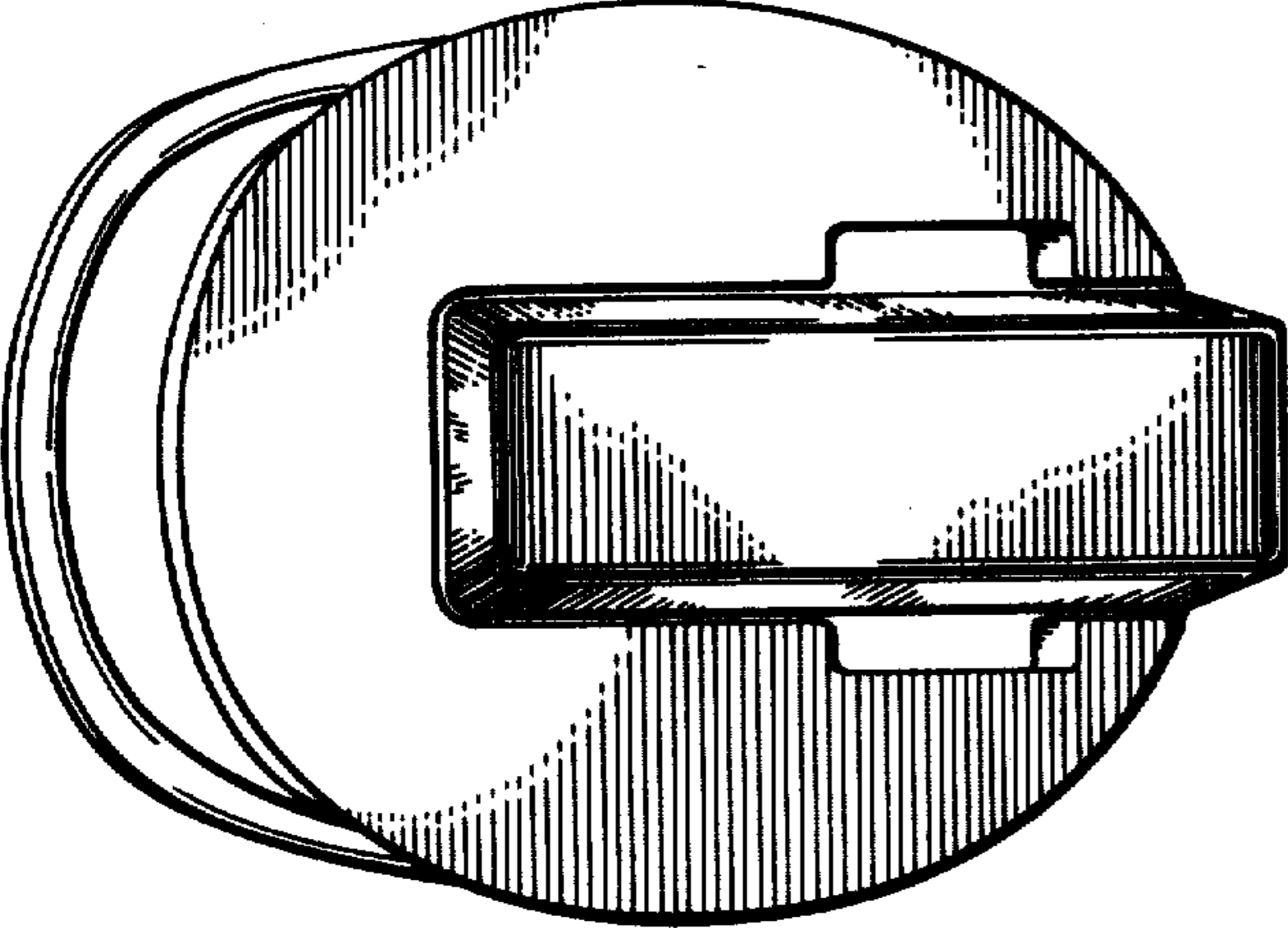

FIG. 6

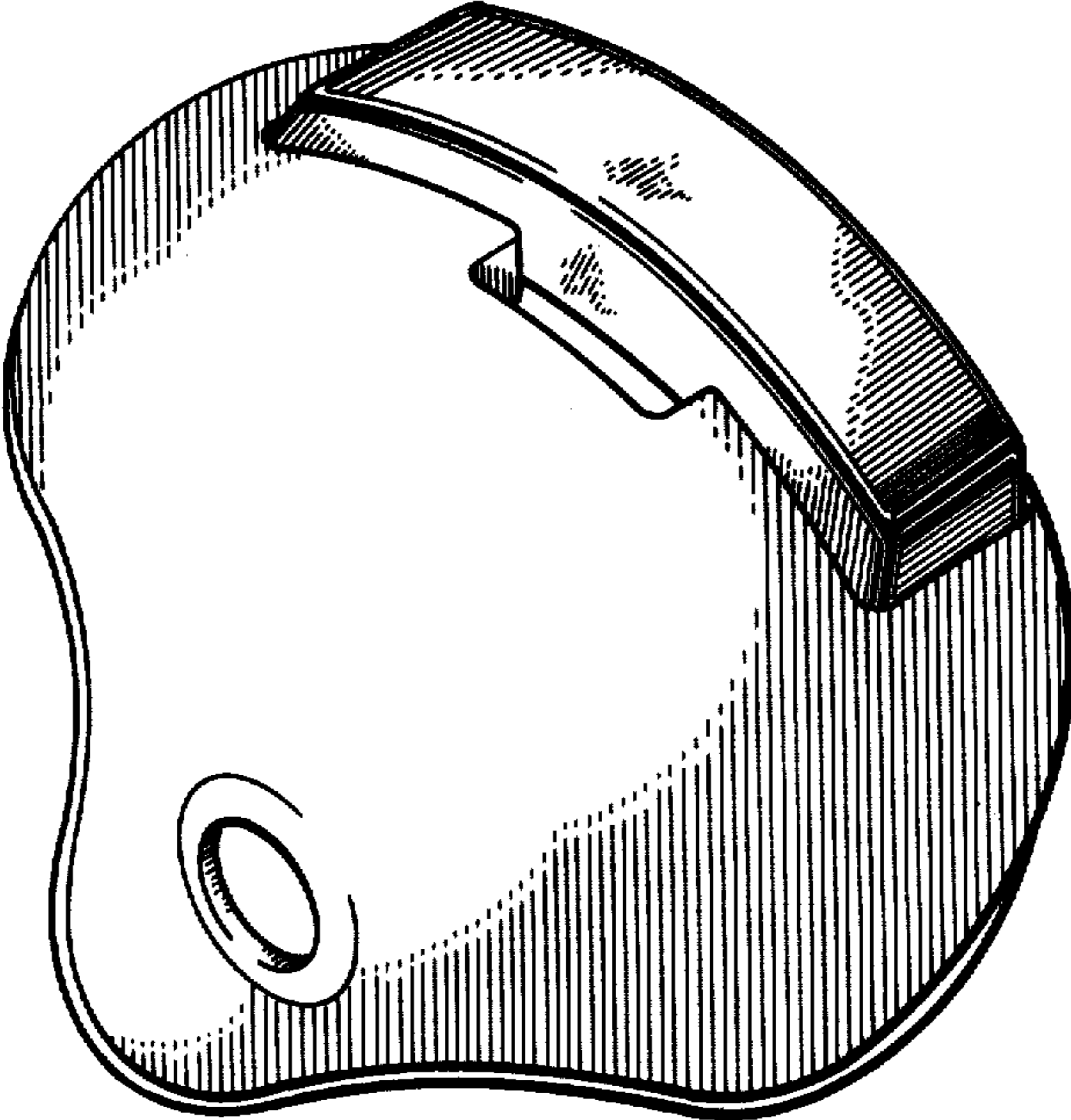

FIG. 7

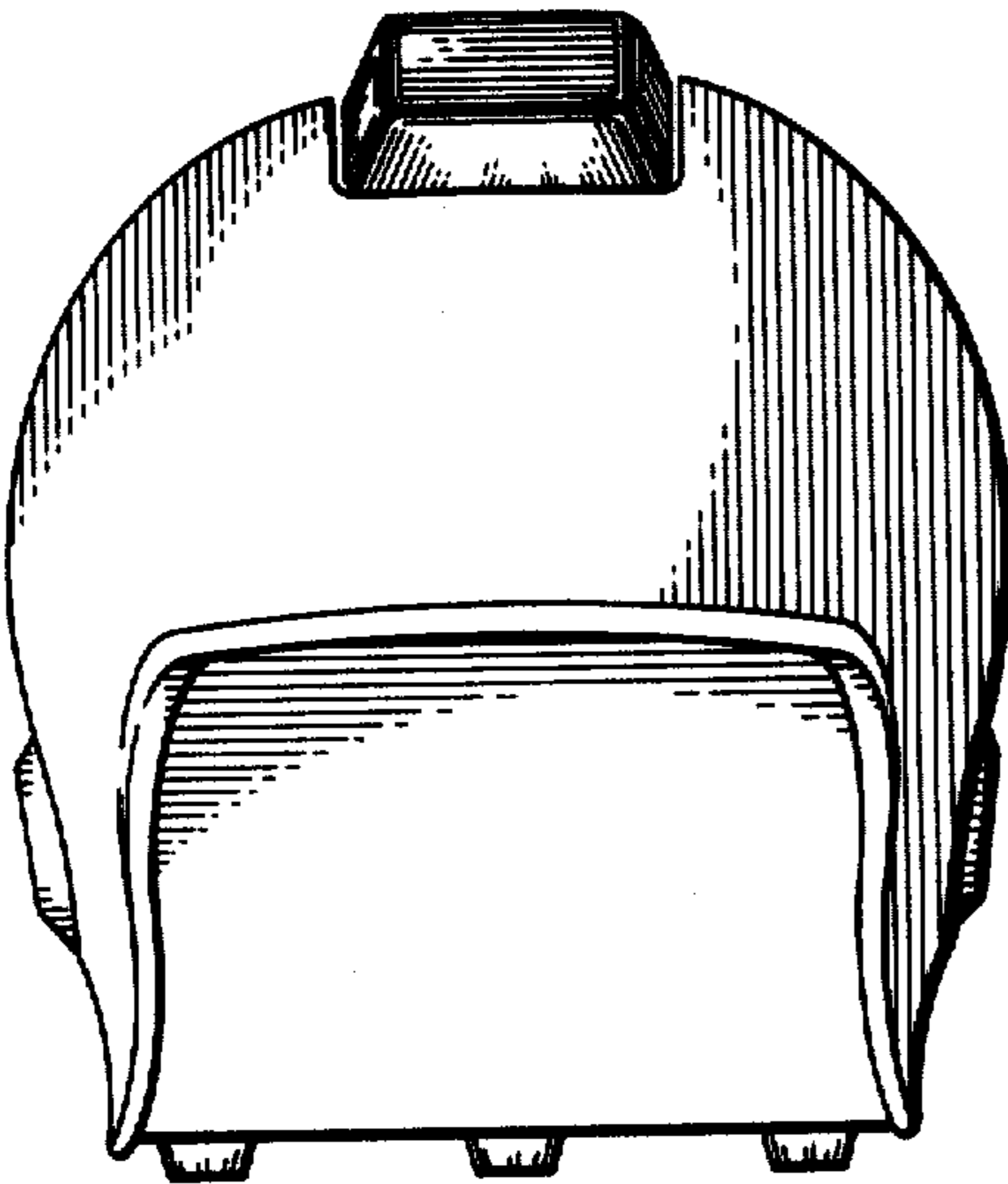

FIG. 8

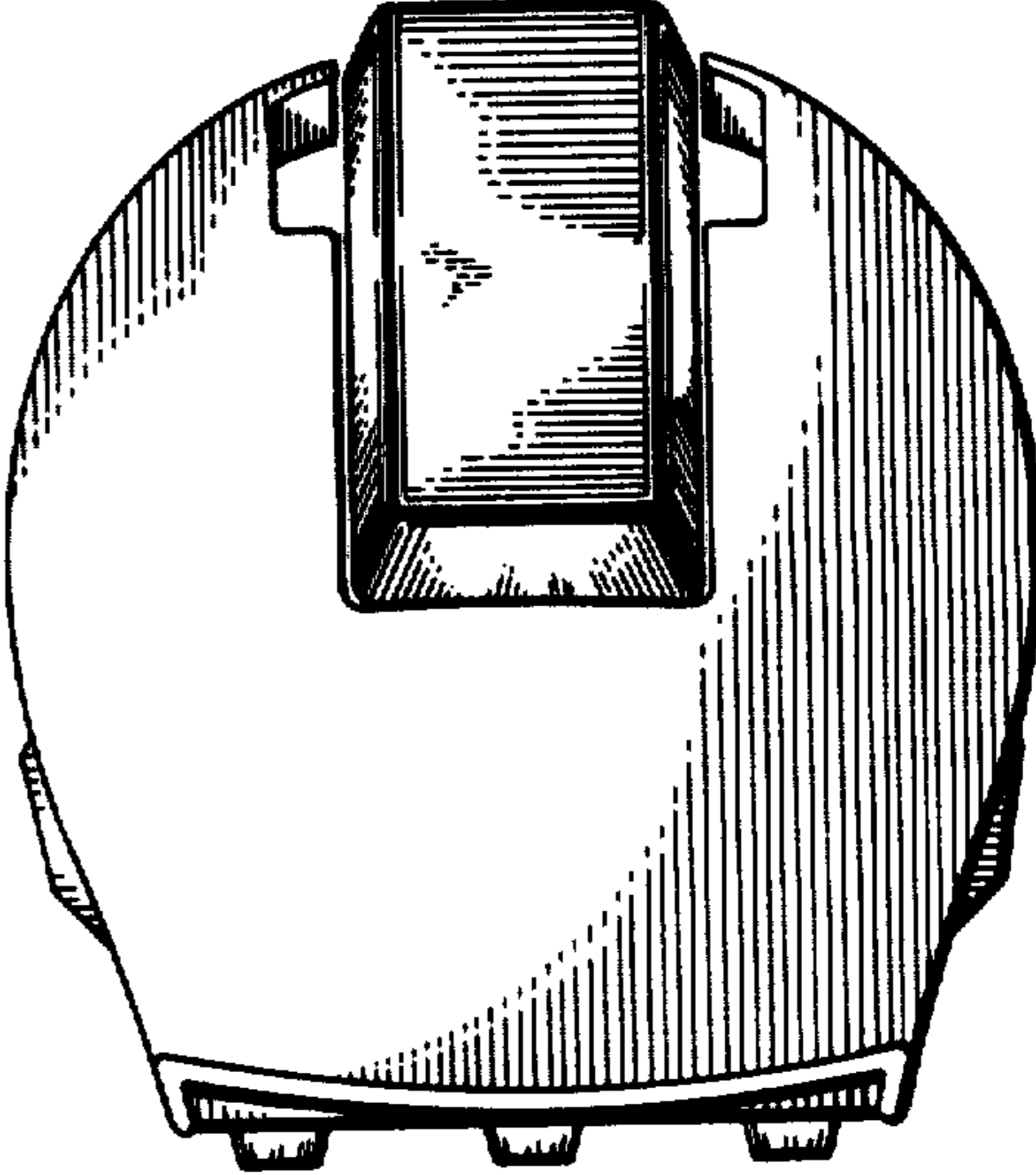

FIG. 9

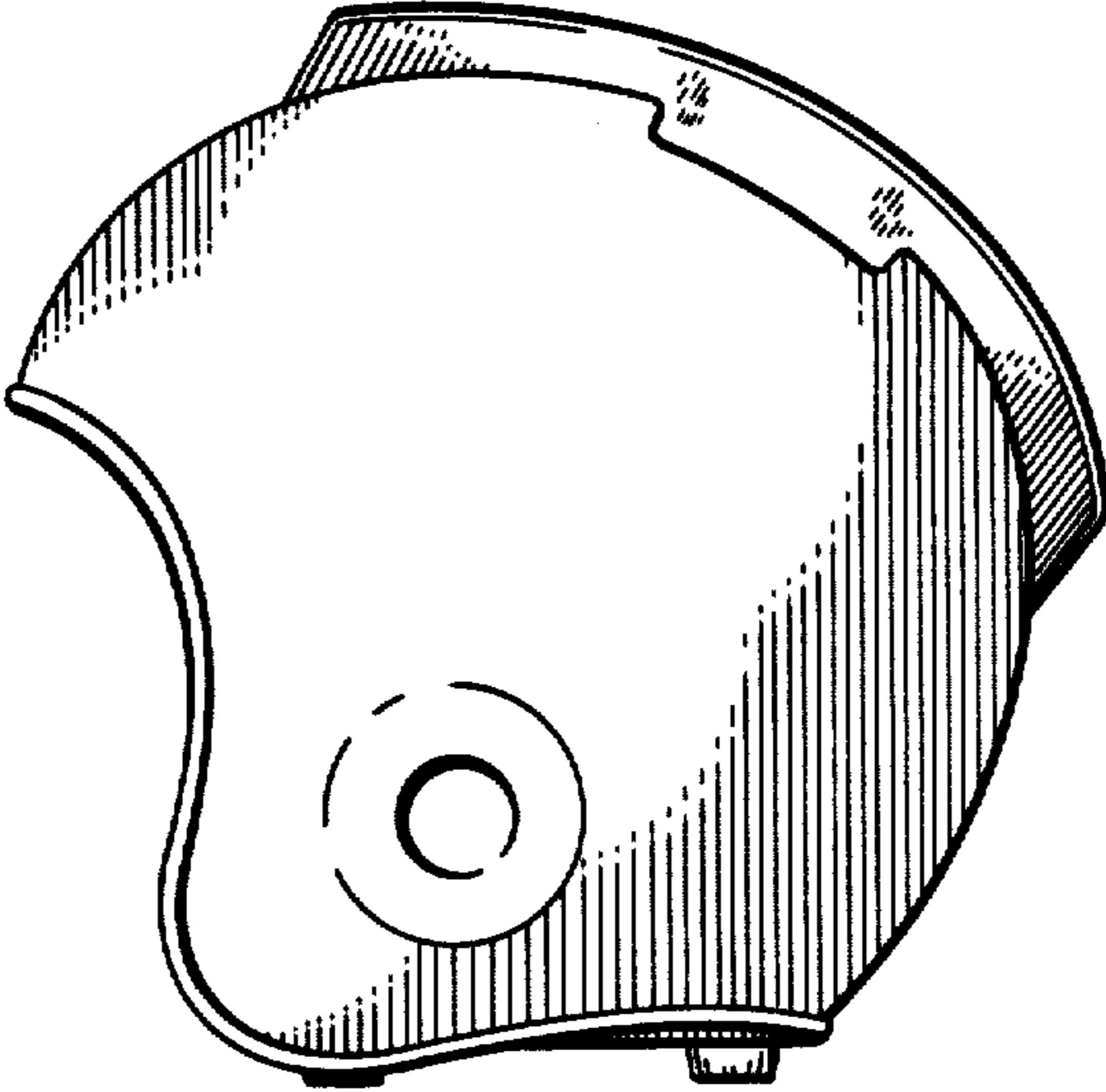

FIG. 10

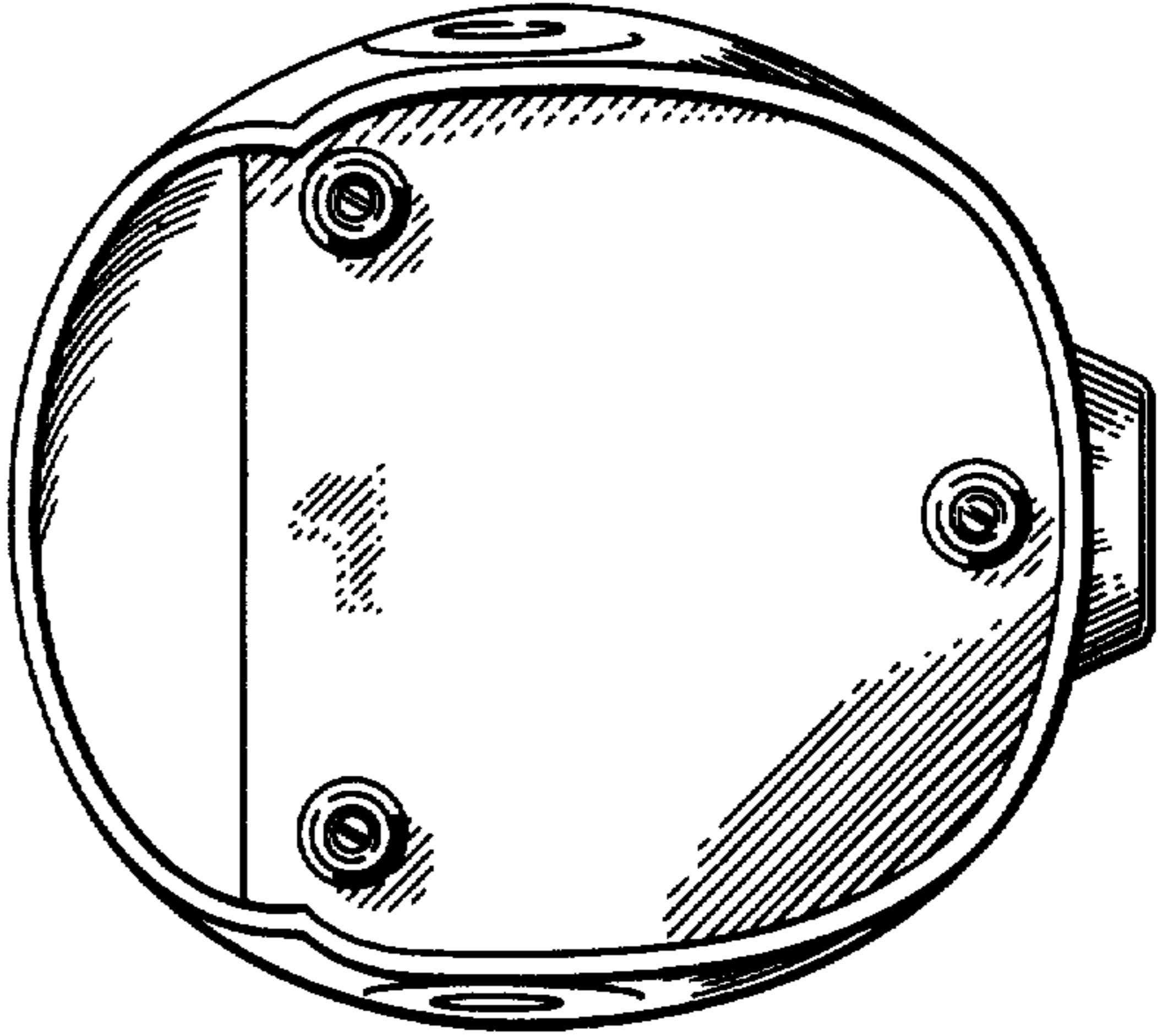

FIG. 12

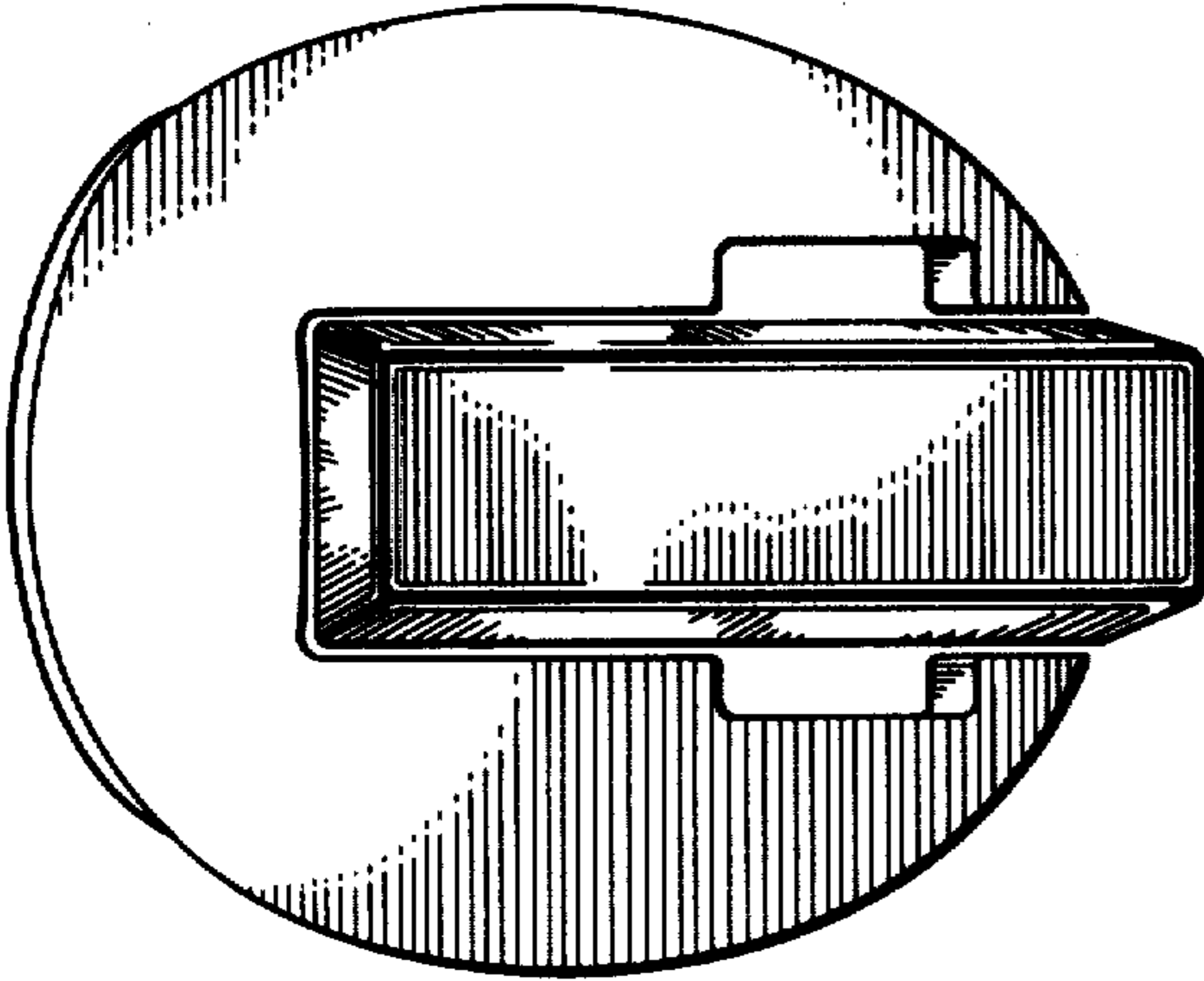

FIG. 11

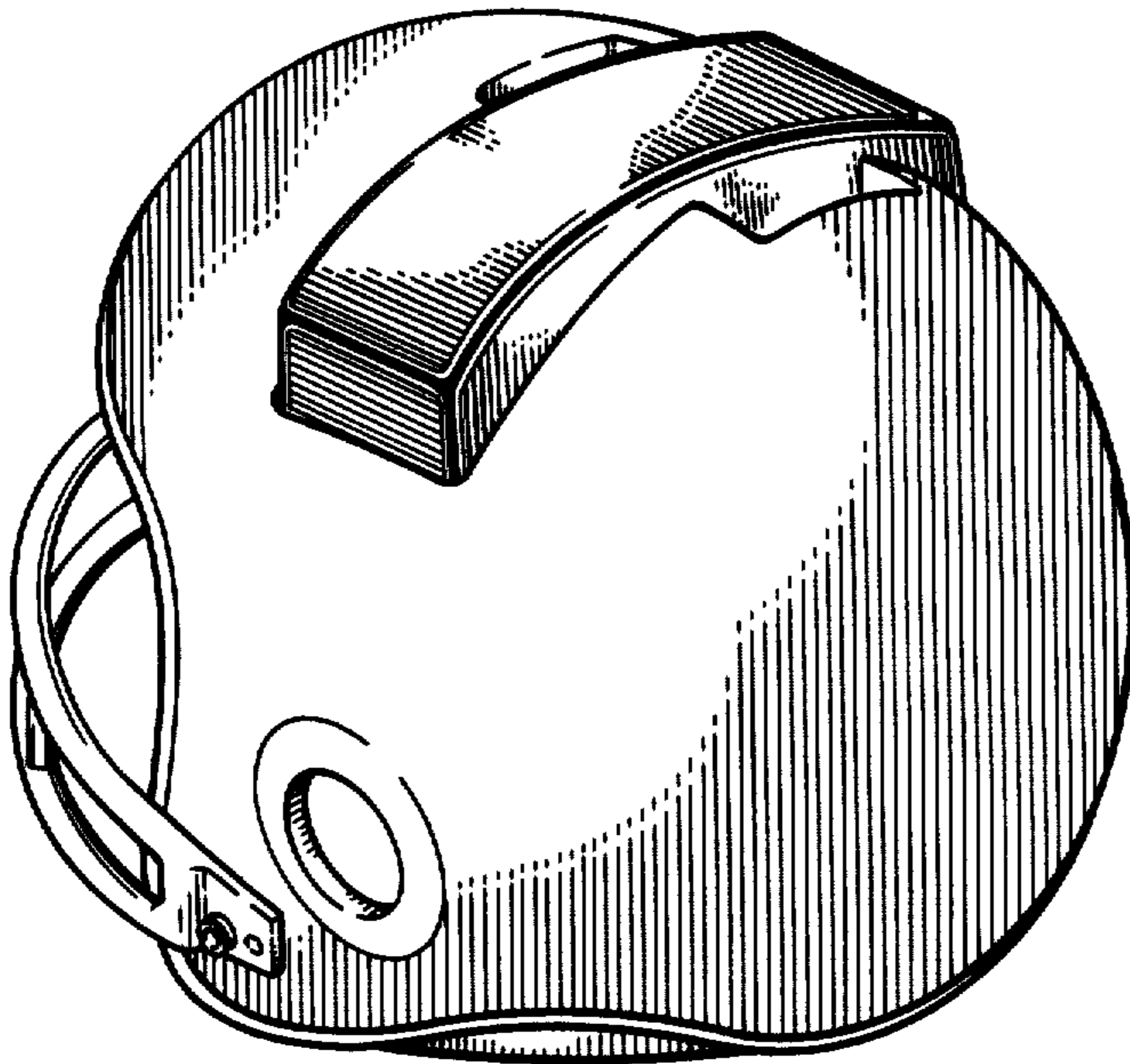

FIG. 13

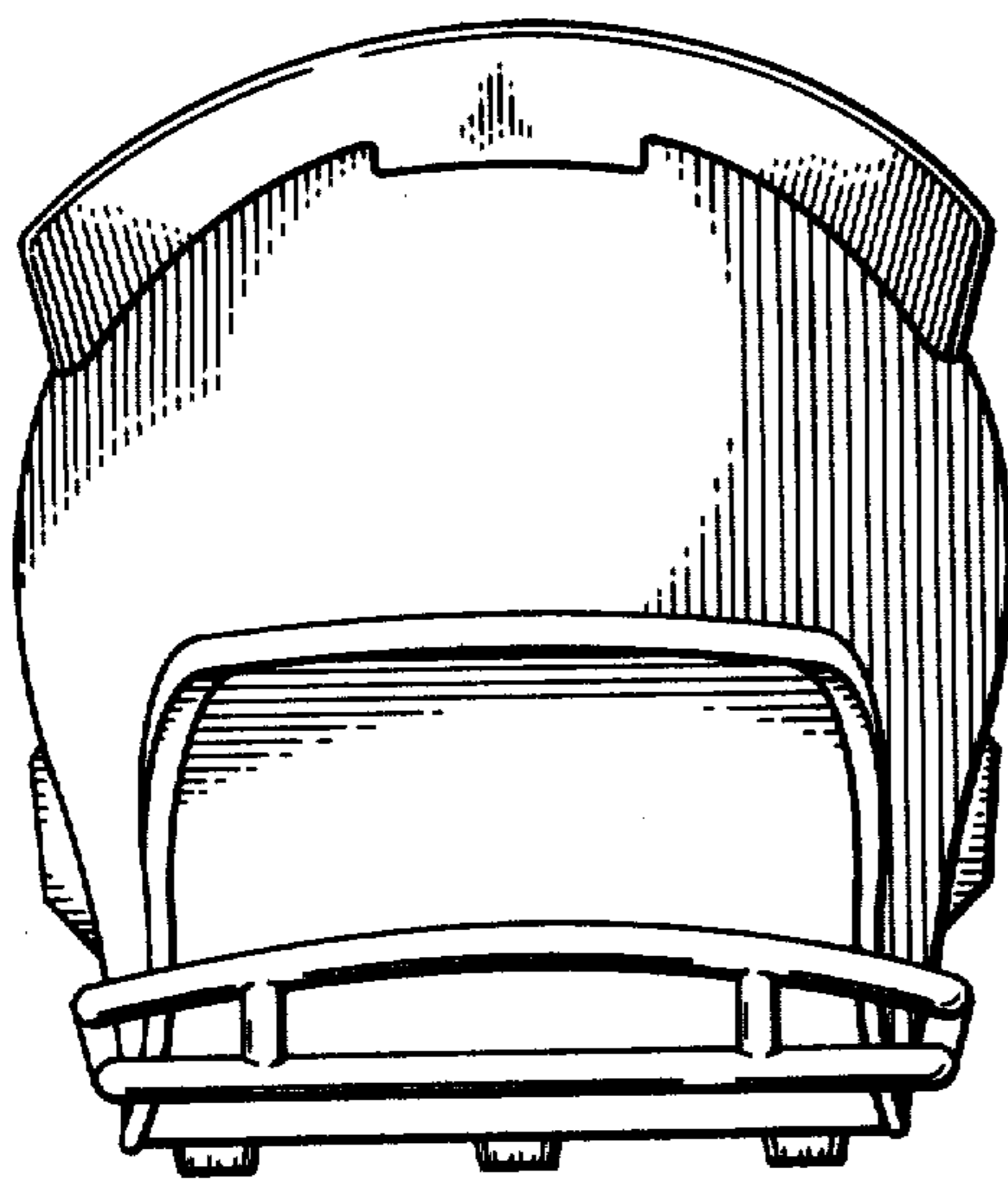

FIG. 14

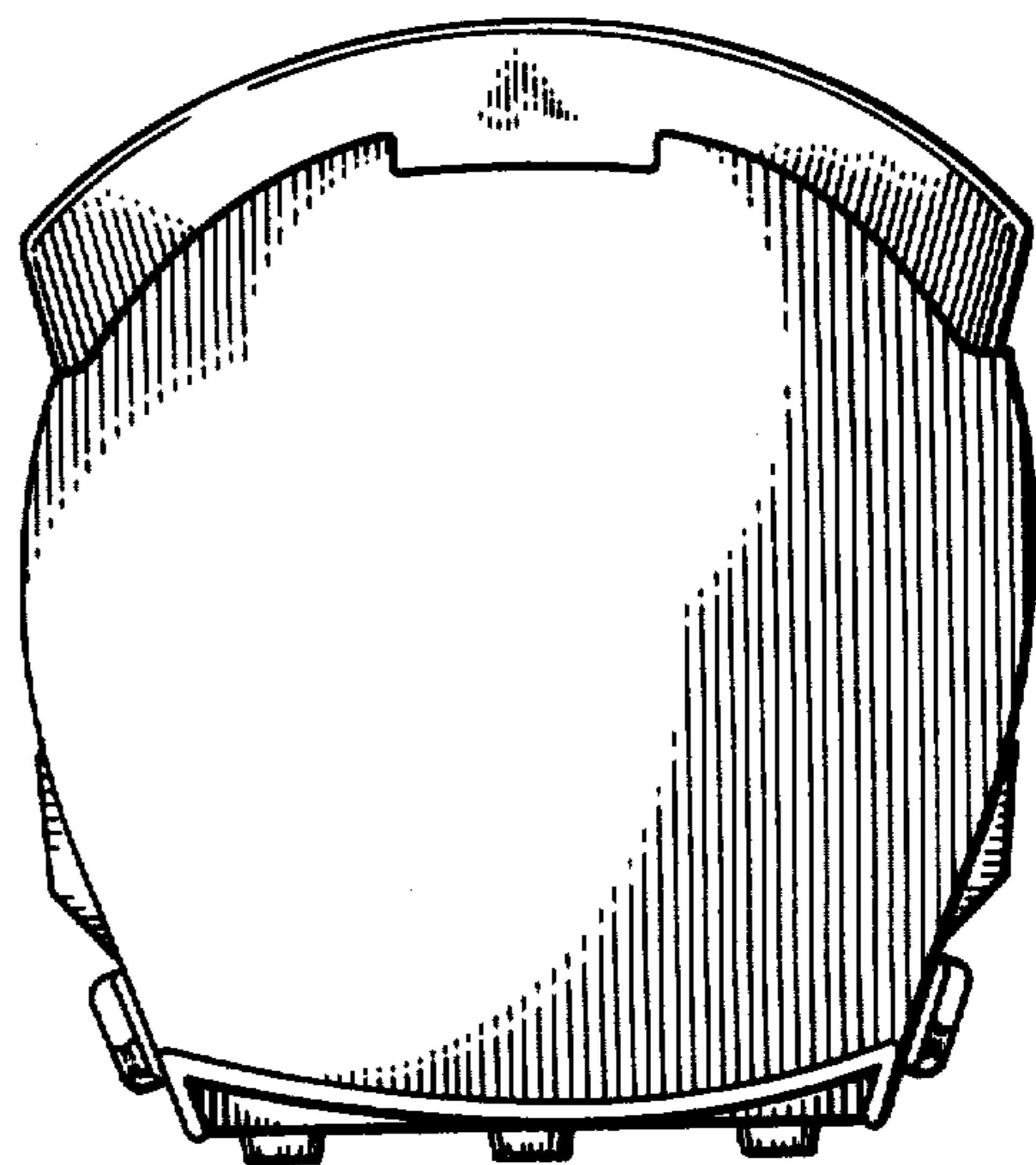

FIG. 15

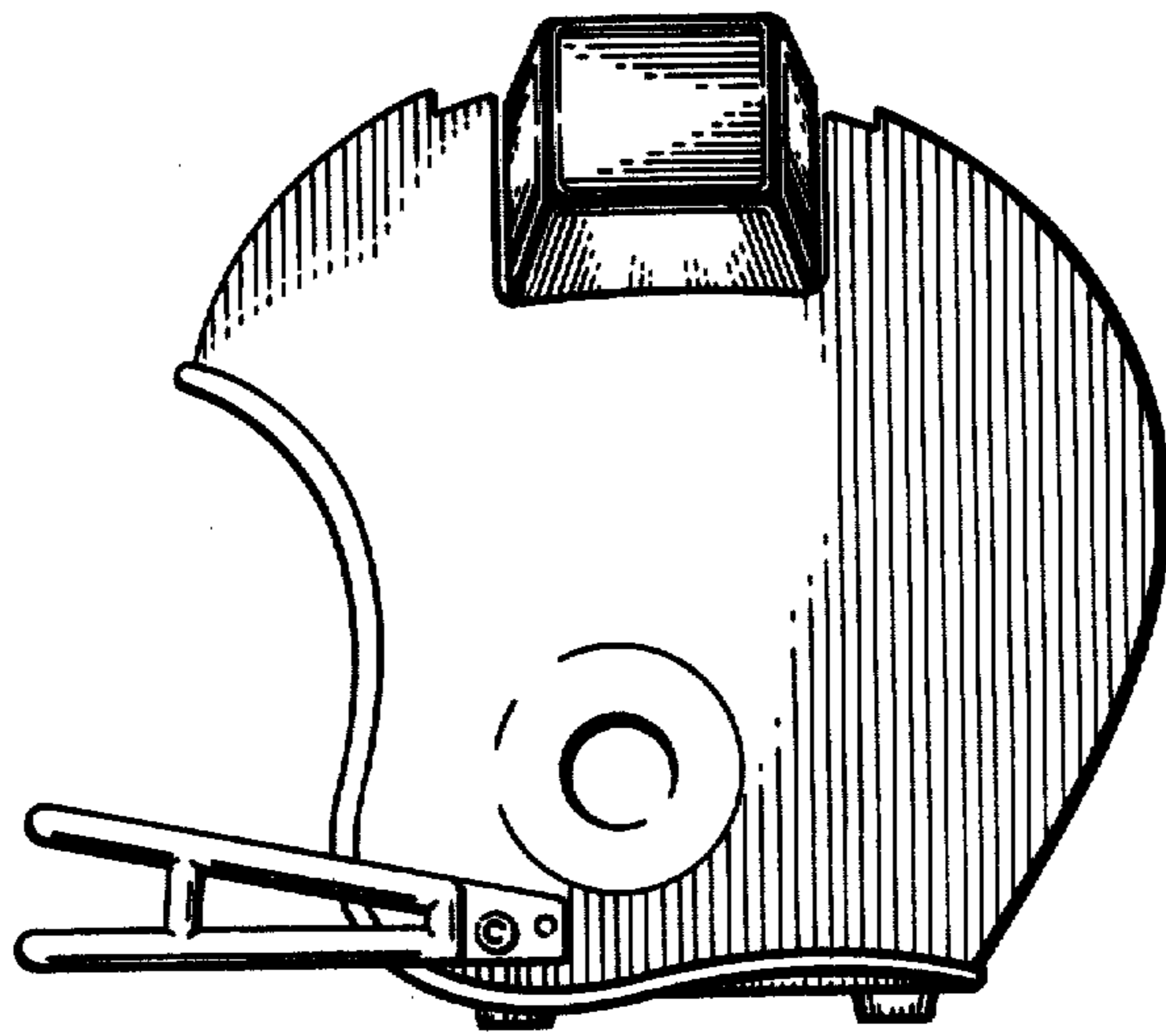

FIG. 16

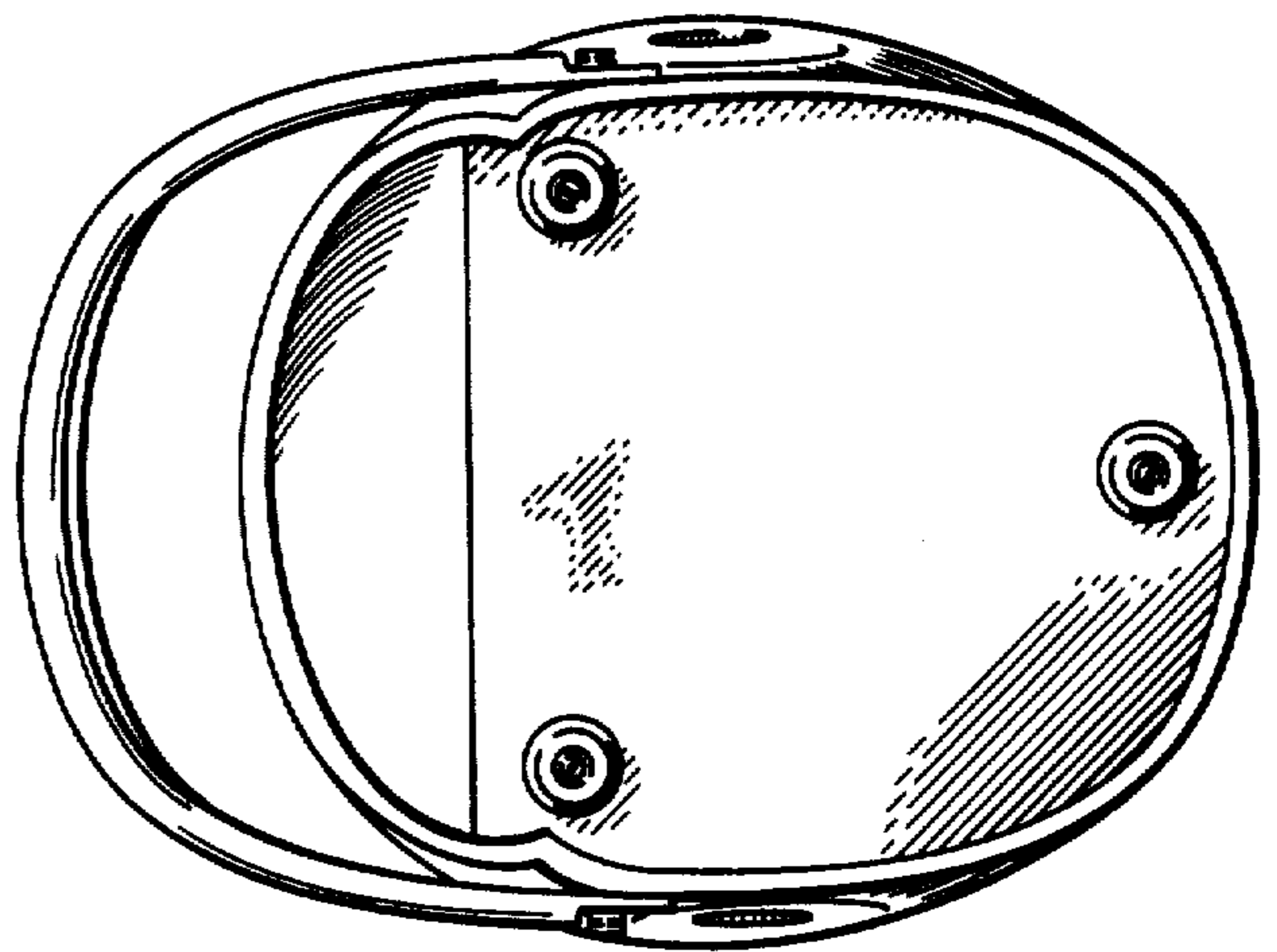

FIG. 18

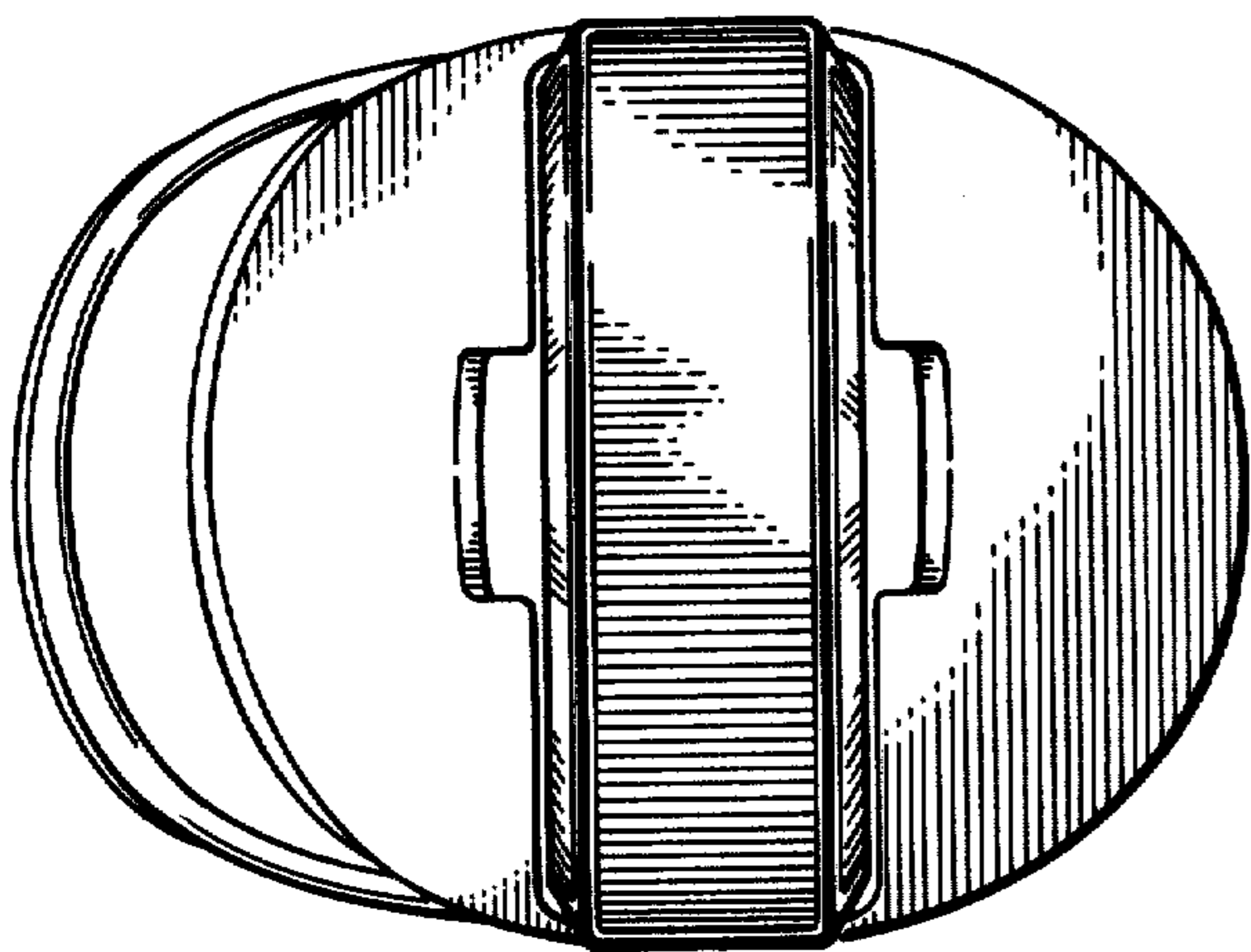

FIG. 17

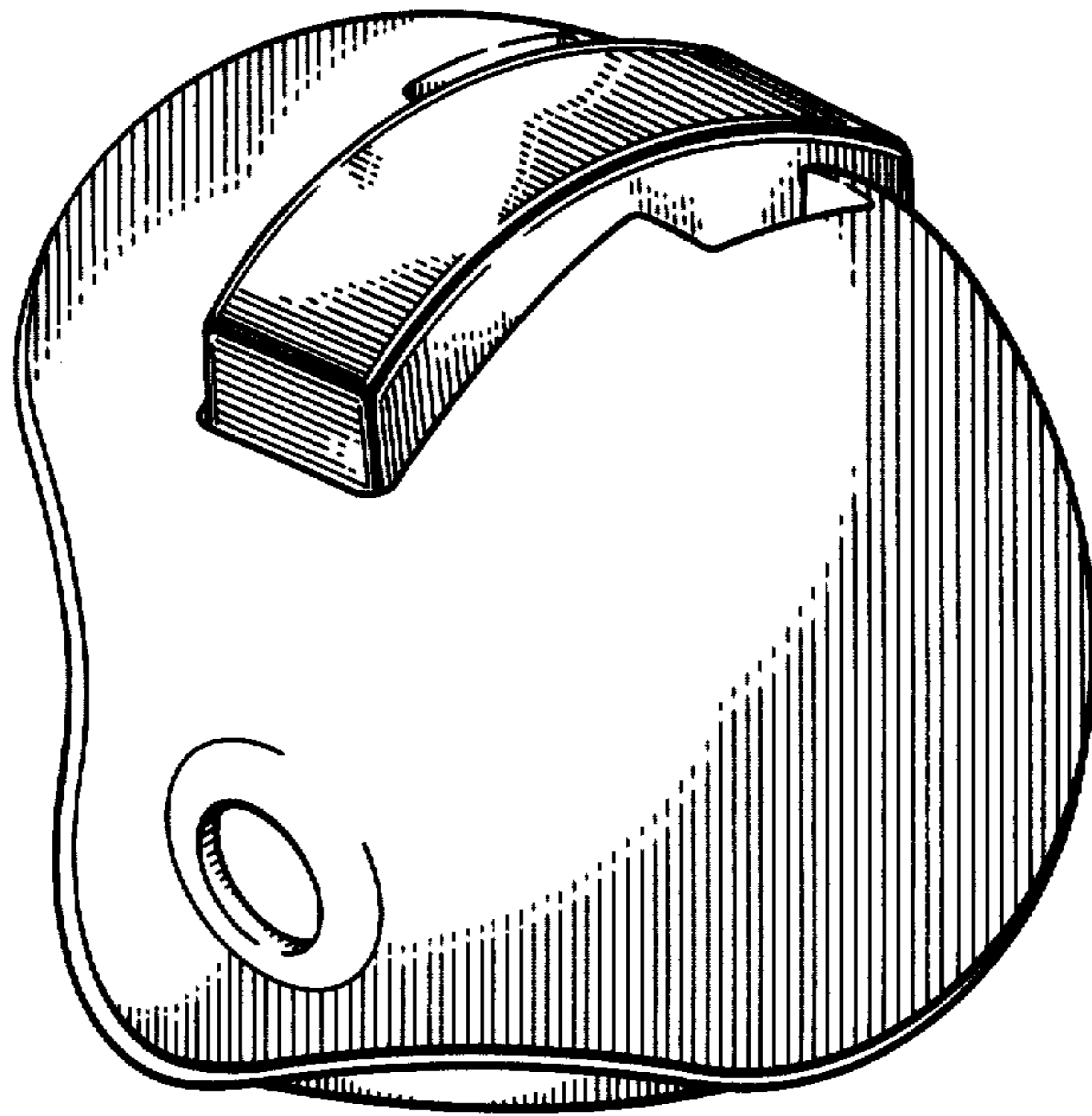

FIG. 19

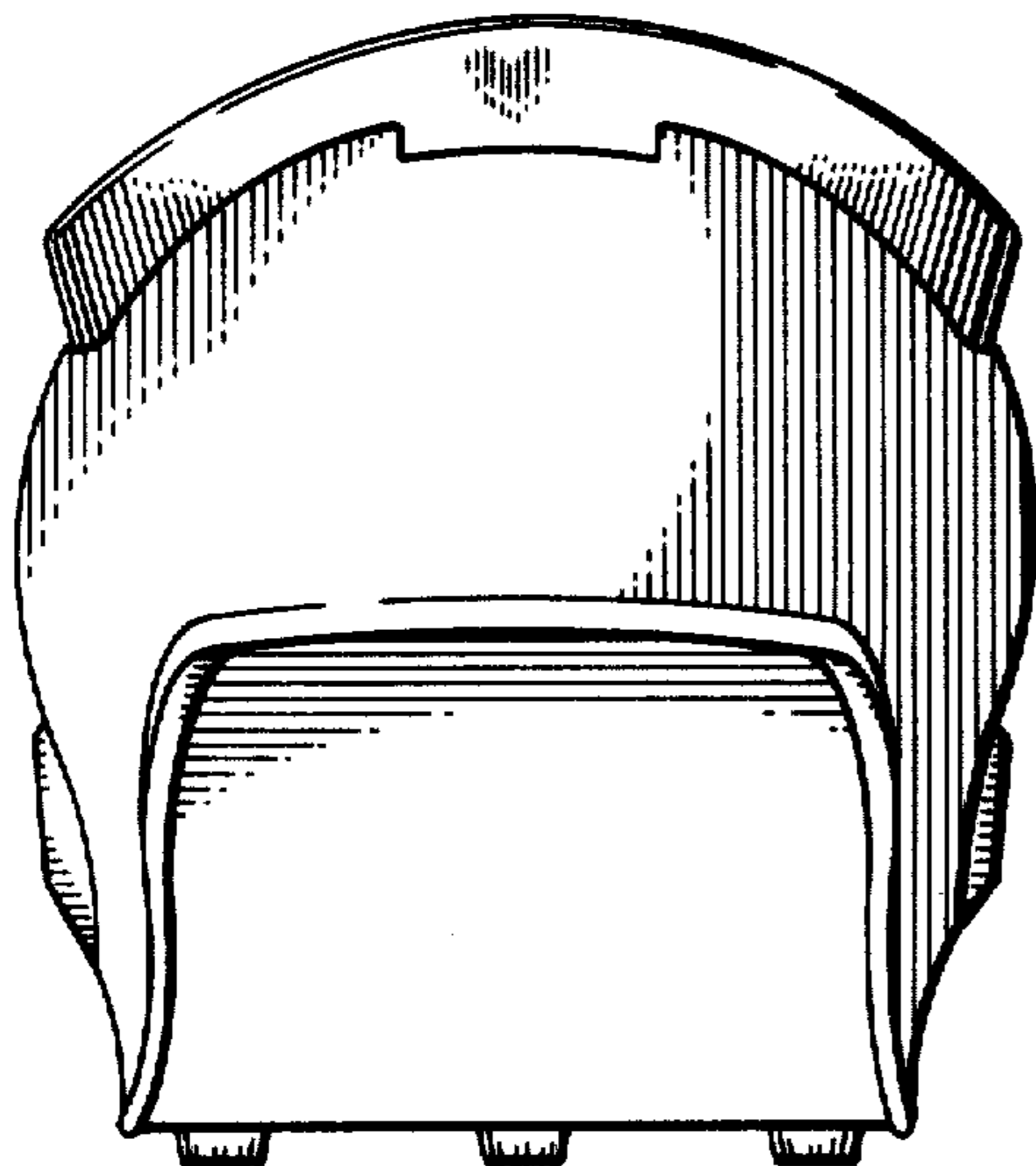

FIG. 20

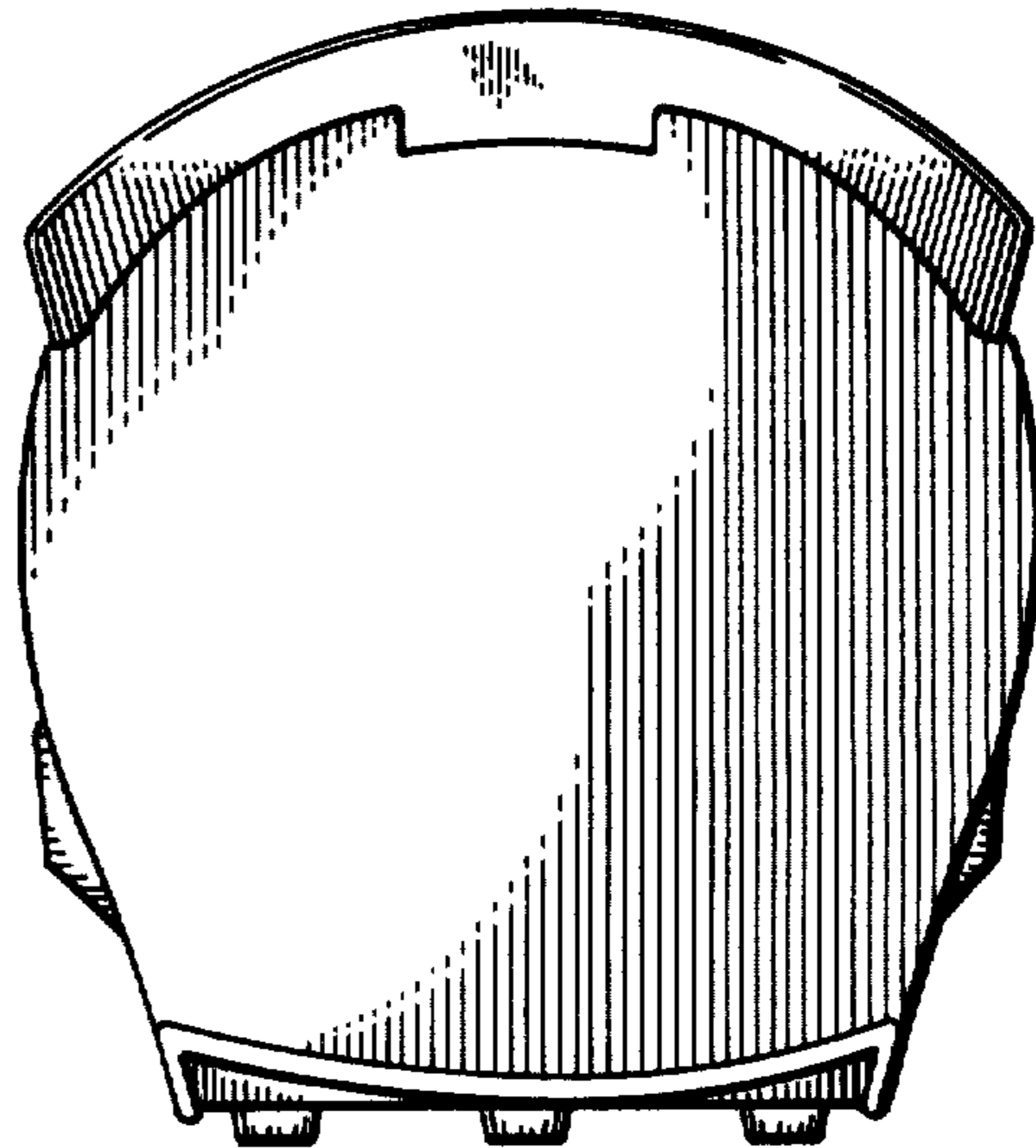

FIG. 21



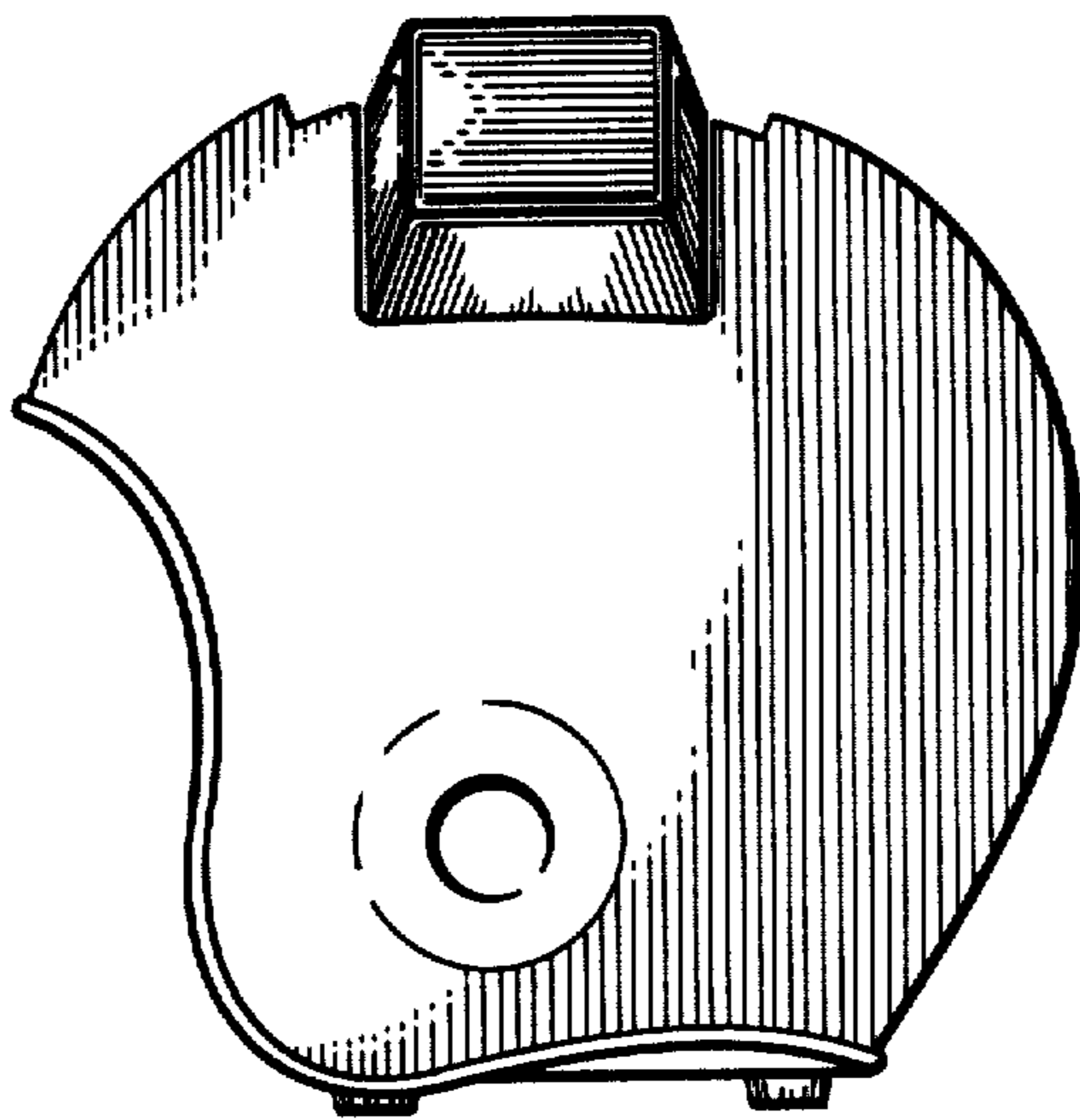

FIG. 22

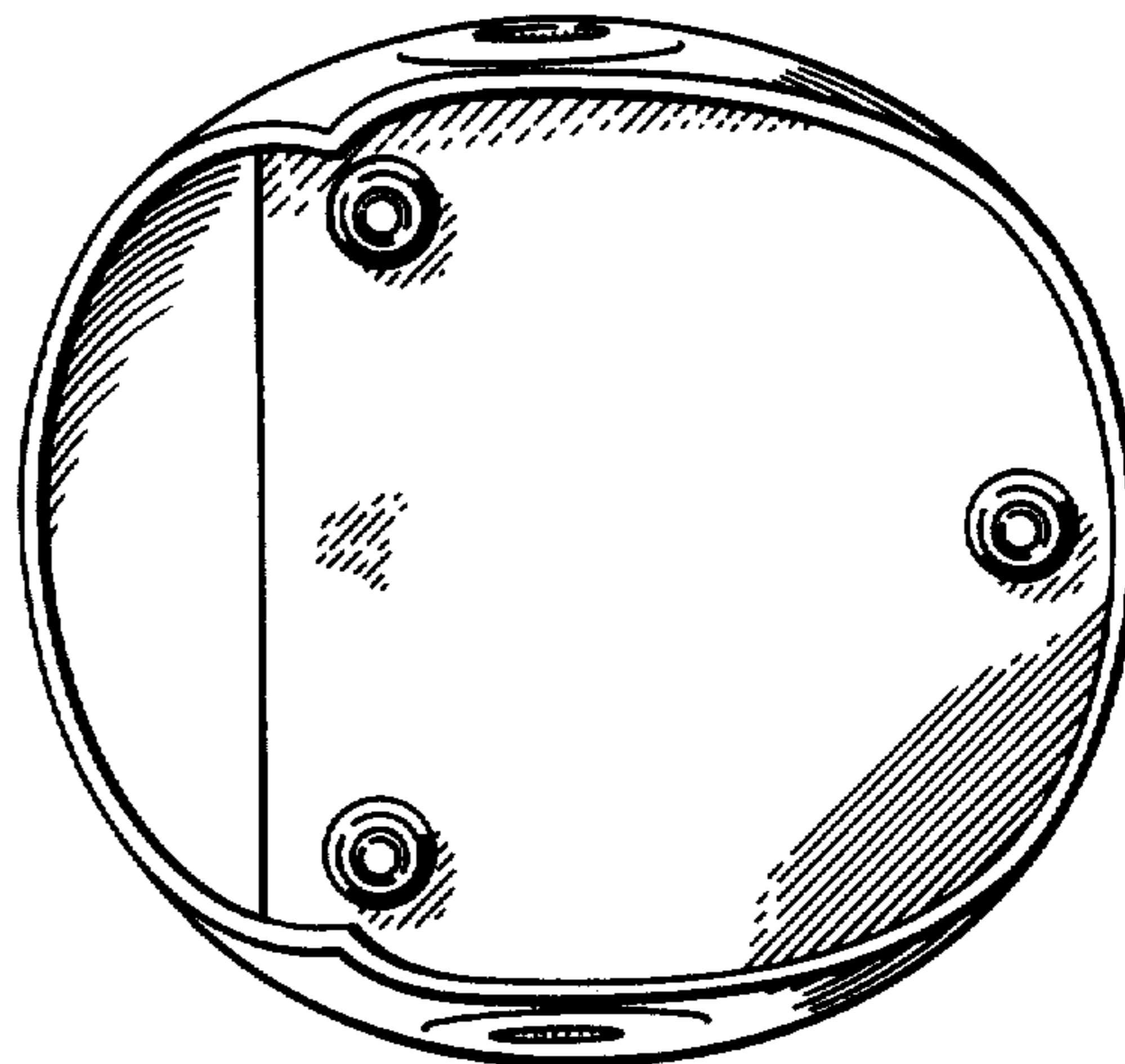

FIG. 24

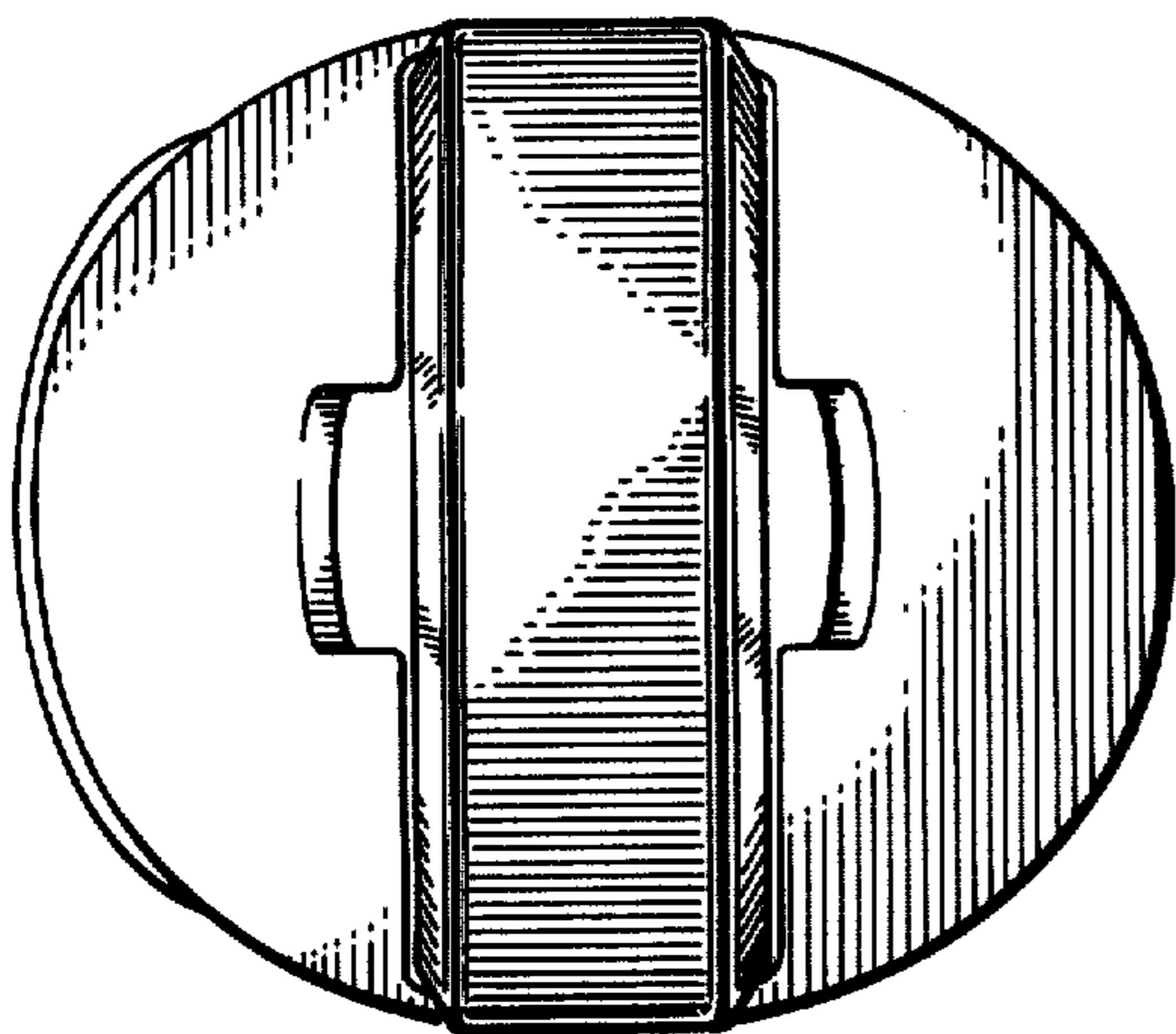

FIG. 23