

[54] BLOOD PRESSURE MEASURING INSTRUMENT OR SIMILAR ARTICLE

[75] Inventors: Alfred Kern, Bachern; Rido Busse, Elchingen; Reinhold Rapp, Ulm-Donau, all of Fed. Rep. of Germany

[73] Assignee: Ebauches S.A., Neuchatel, Switzerland

[\*\*] Term: 14 Years

[21] Appl. No.: 161,743

[22] Filed: Jun. 23, 1980

[30] Foreign Application Priority Data

Jan. 18, 1980 [DE] Fed. Rep. of Germany ... DMA/000 026

[51] Int. Cl. .... D24-02

[52] U.S. Cl. .... D24/21; D24/17

[58] Field of Search ..... 128/685, 824, 21, 625, 128/680, 678; D24/17, 21, 99, 8

[56] References Cited

U.S. PATENT DOCUMENTS

- D. 248,490 7/1978 Manno ..... D24/21
D. 250,046 10/1978 Sakamoto et al. .... D24/21
D. 255,381 6/1980 Schmidt ..... D24/21
D. 260,885 9/1981 Jones ..... D24/17 X
3,543,745 12/1970 Rosenstein ..... 128/684
3,613,668 10/1971 Beck et al. .... 128/685

4,248,242 2/1981 Tamm ..... 128/685 X

FOREIGN PATENT DOCUMENTS

2358788 11/1972 Fed. Rep. of Germany .

Primary Examiner—Bernard Ansher
Attorney, Agent, or Firm—Werner W. Kleeman

[57] CLAIM

The ornamental design for a blood pressure measuring instrument or similar article, as shown and described.

DESCRIPTION

FIG. 1 is a front view of a first embodiment of our blood pressure measuring instrument or similar article showing our new design;

FIG. 2 is a side view thereof, viewed from the left side of FIG. 1;

FIG. 3 is a rear view thereof;

FIG. 4 is a side view, opposite to the side shown in FIG. 2;

FIG. 5 is a top plan view thereof;

FIG. 6 is a bottom plan view thereof;

FIG. 7 is a front view of a second embodiment of our blood pressure measuring instrument or similar article;

FIG. 8 is a side view thereof, viewed from the left side of FIG. 7;

FIG. 9 is a rear view thereof;

FIG. 10 is a side view, opposite to the side shown in FIG. 8;

FIG. 11 is a top plan view thereof; and

FIG. 12 is a bottom plan view thereof.

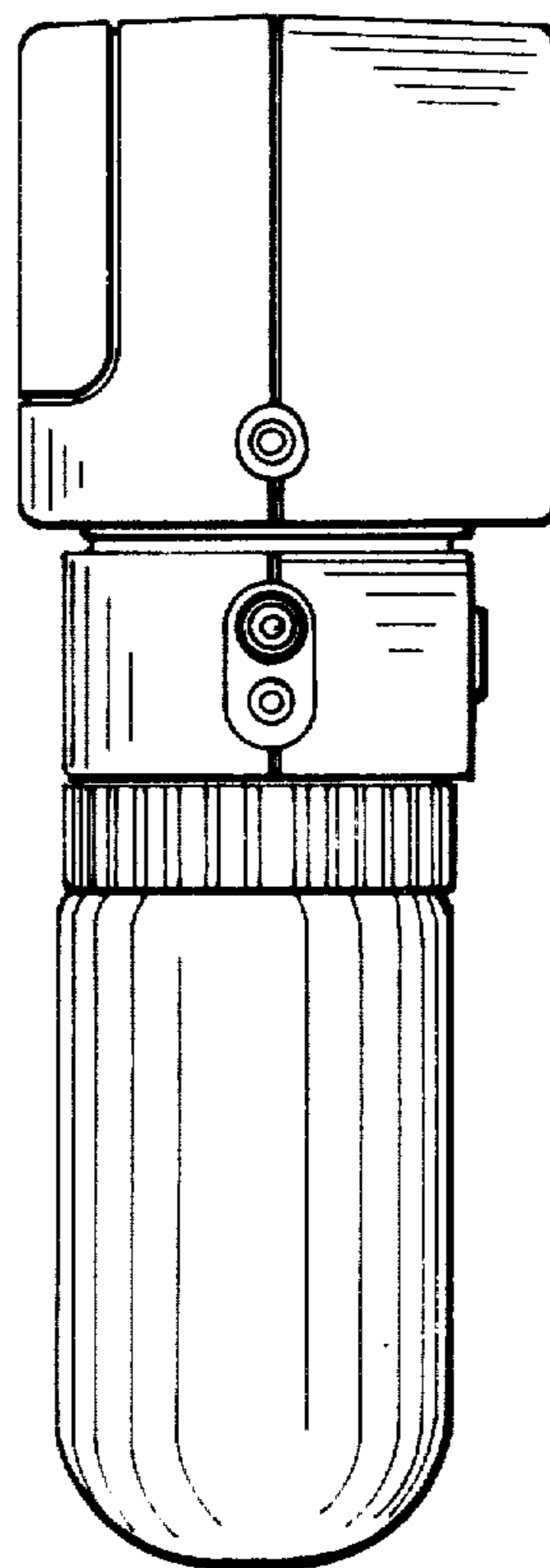
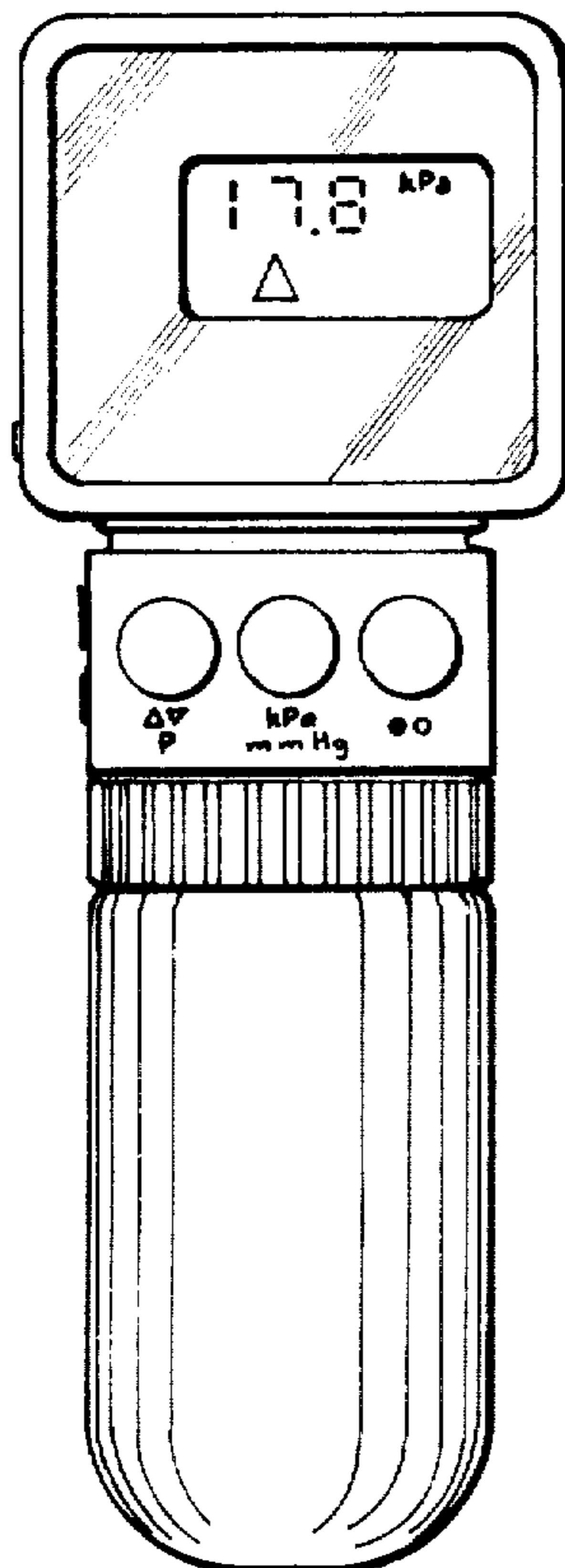

Fig. 1

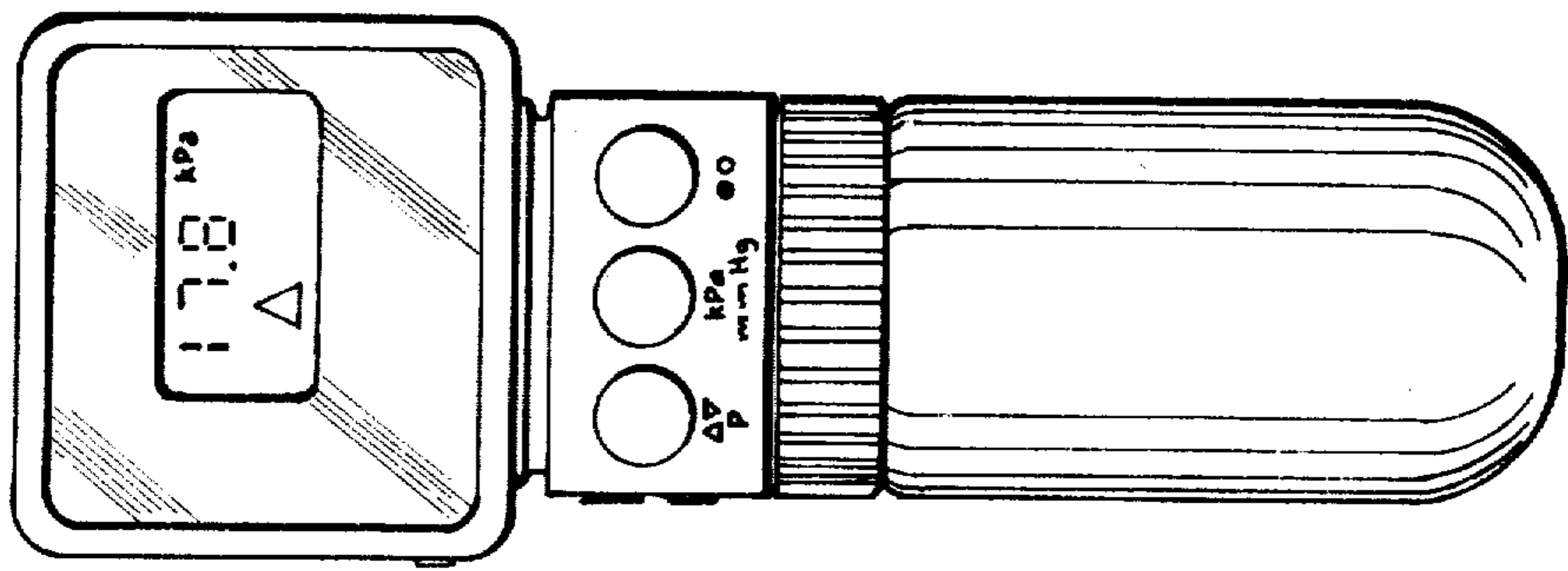

Fig. 2

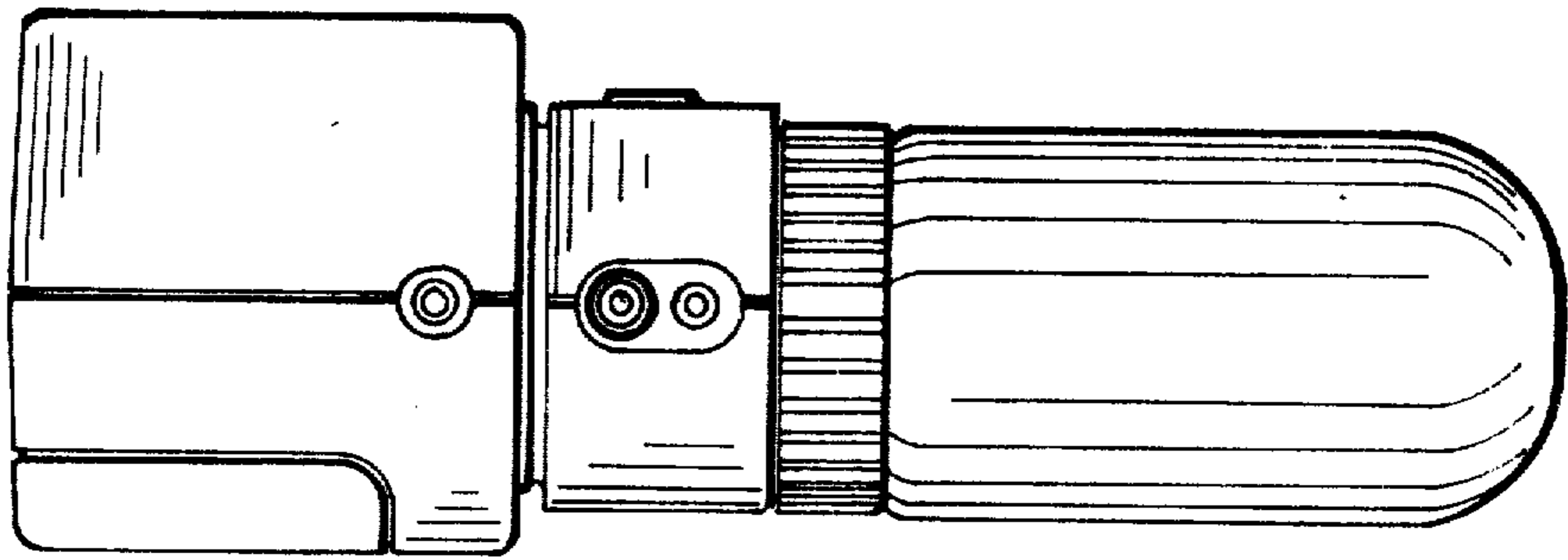
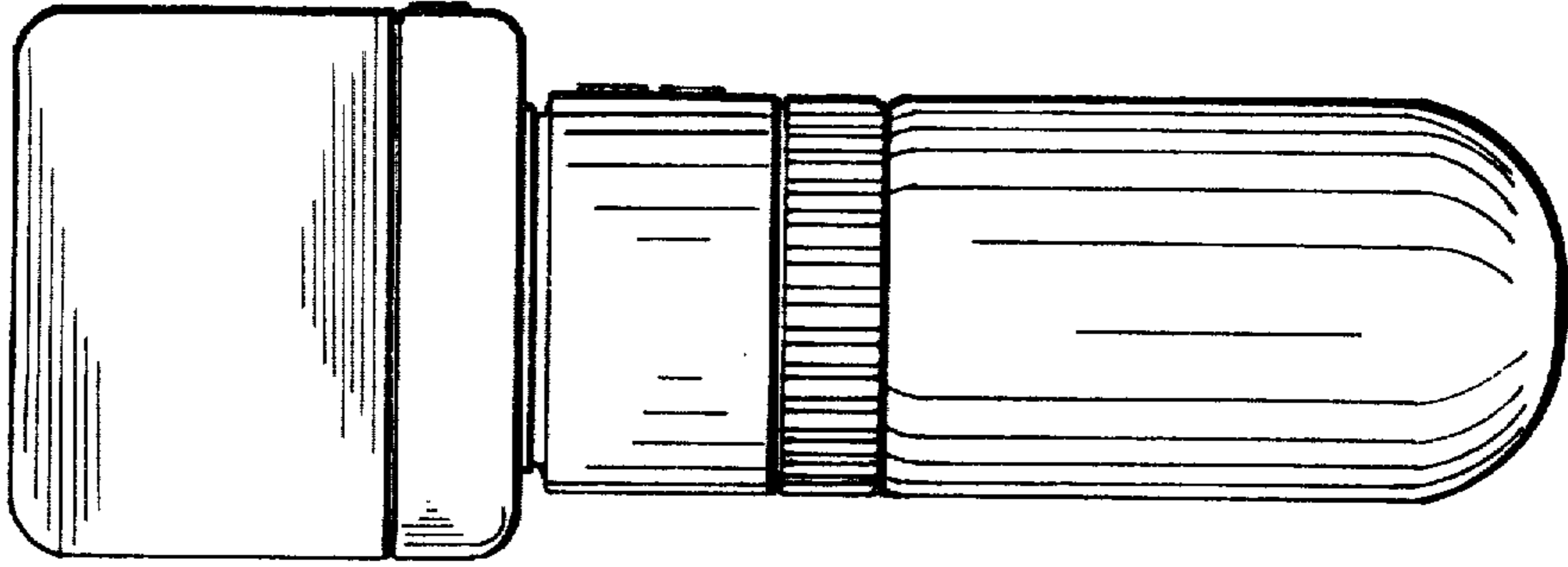

Fig. 3



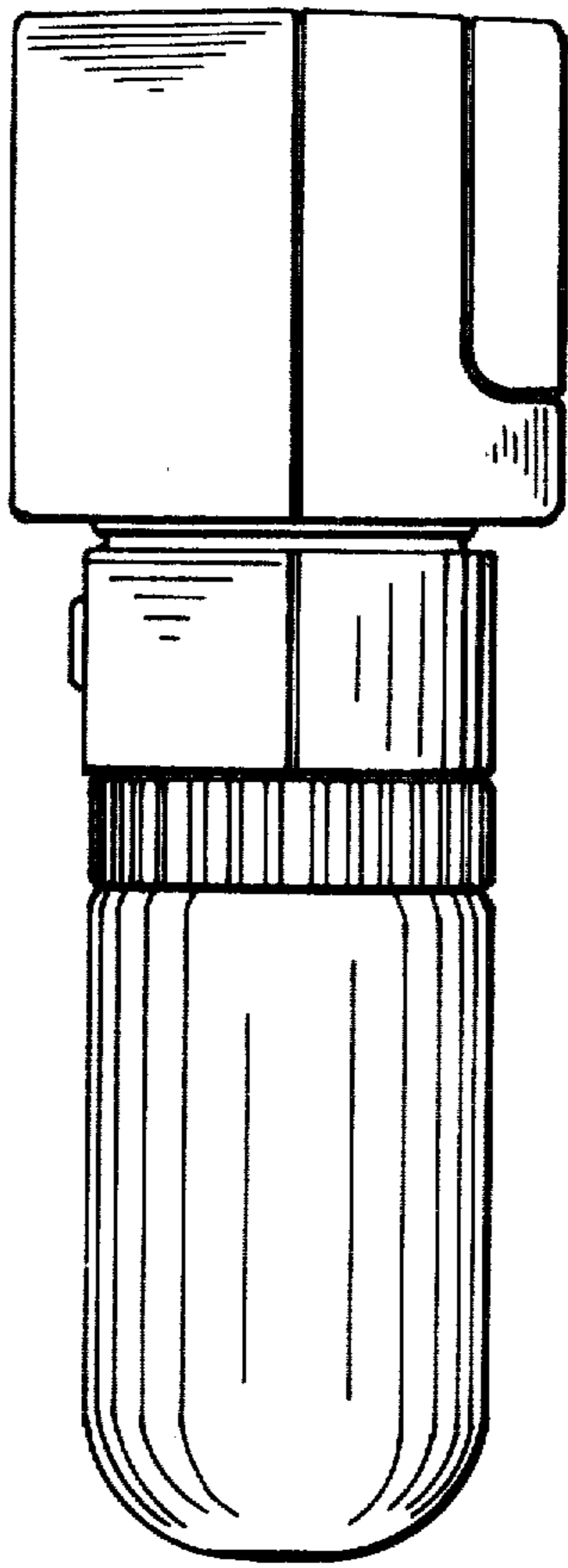

Fig. 4

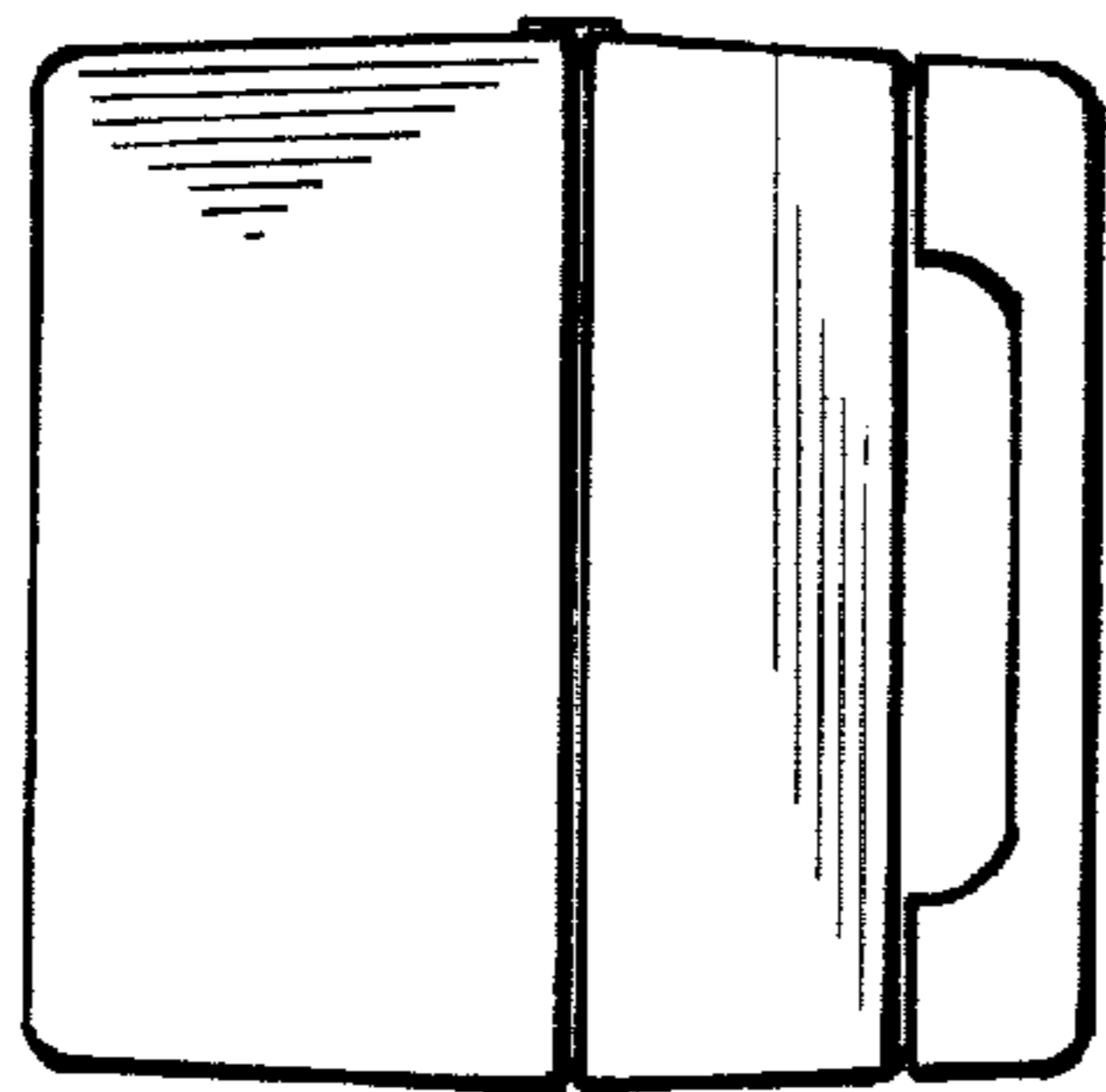

Fig. 5

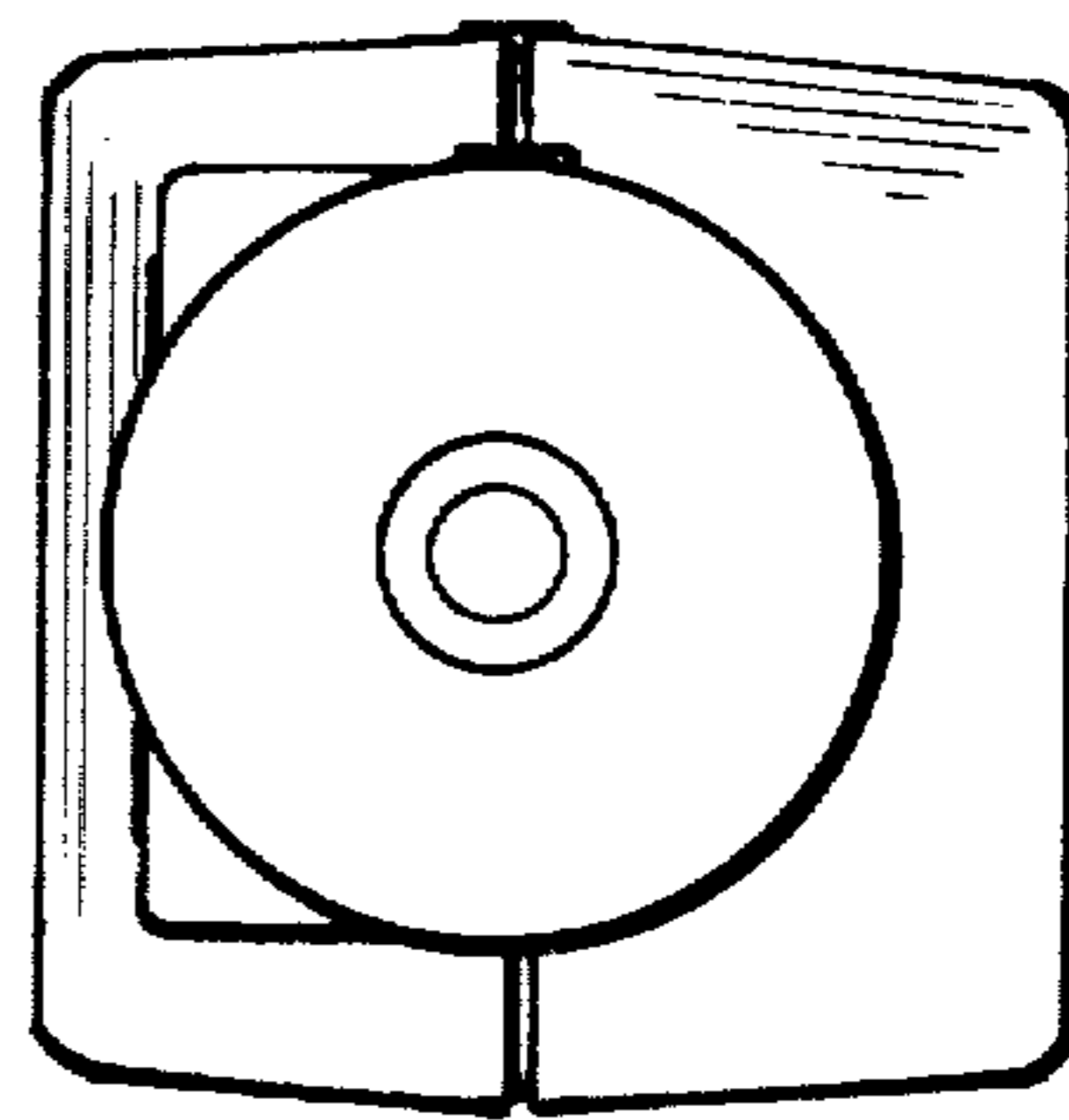

Fig. 6

Fig. 9

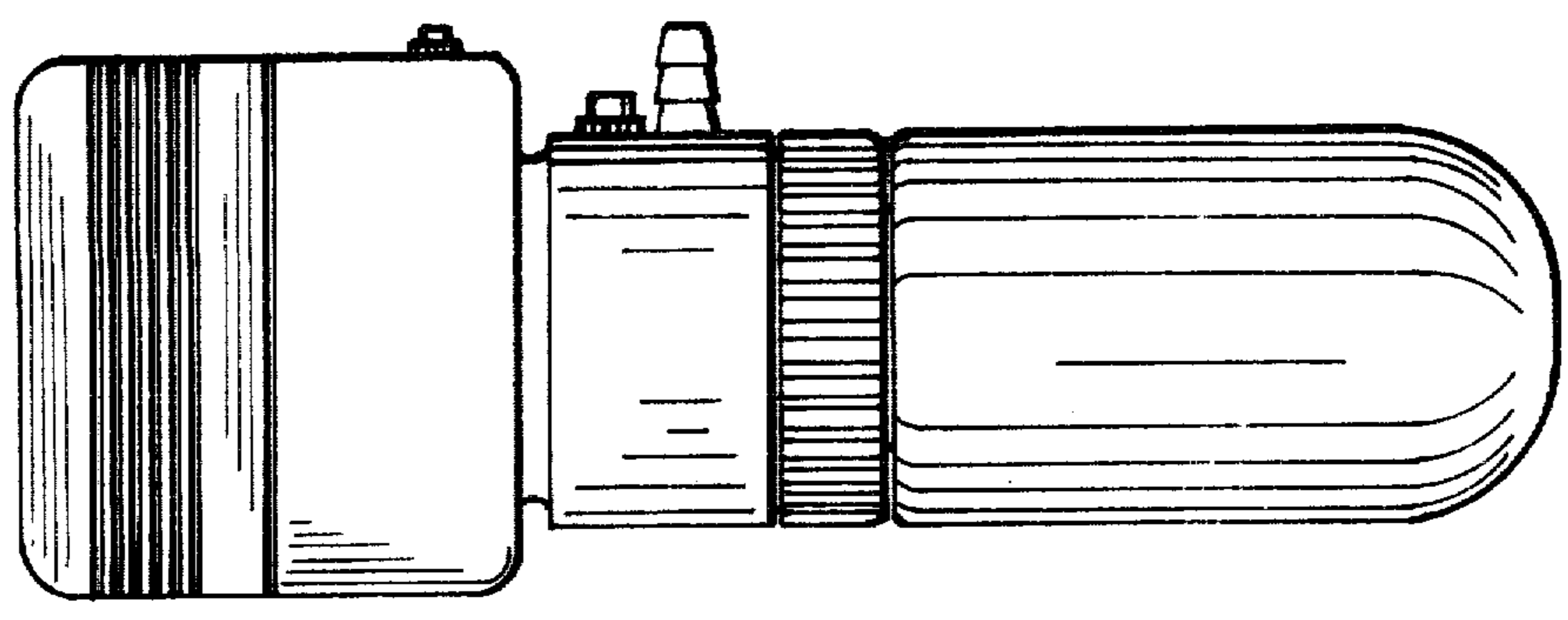

Fig. 8

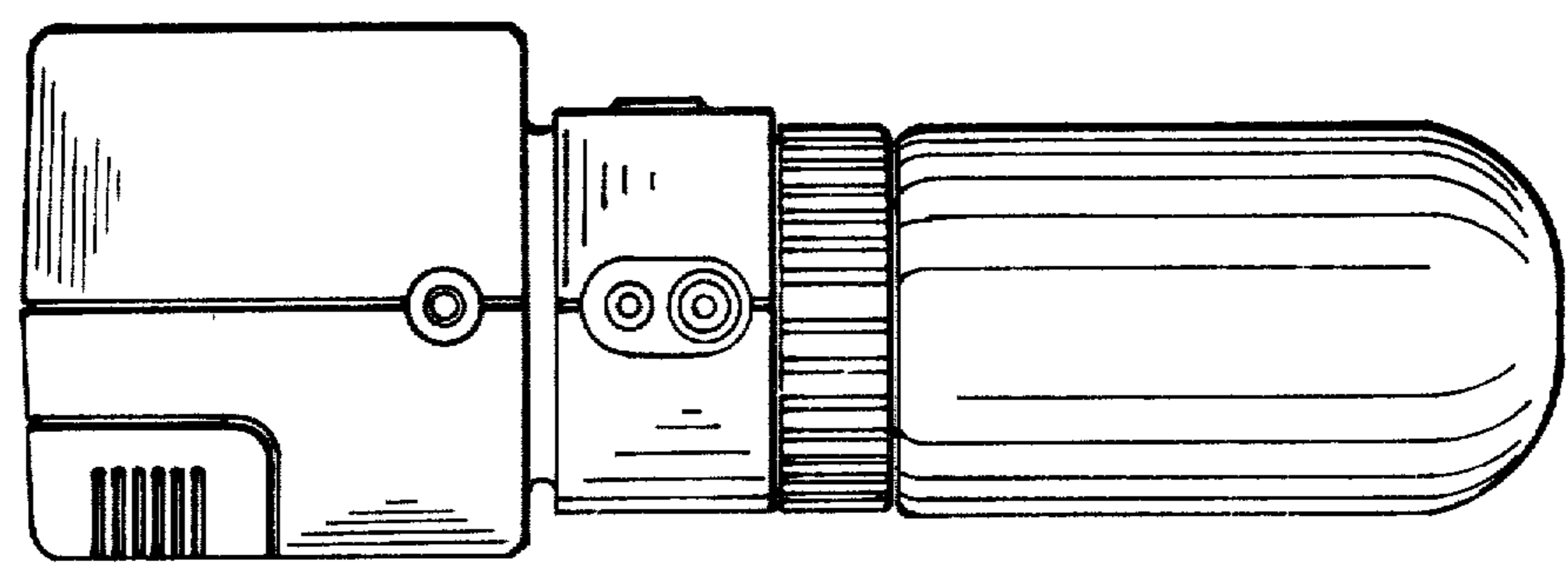
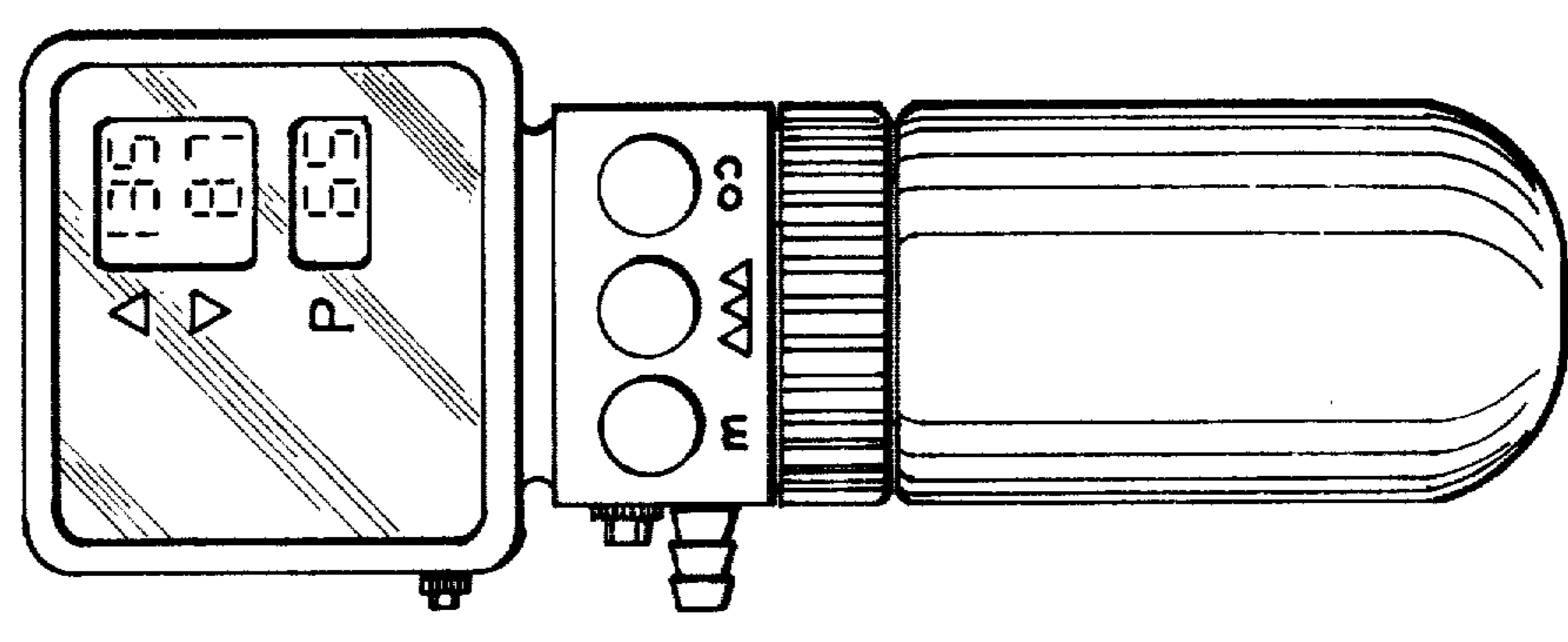

Fig. 7



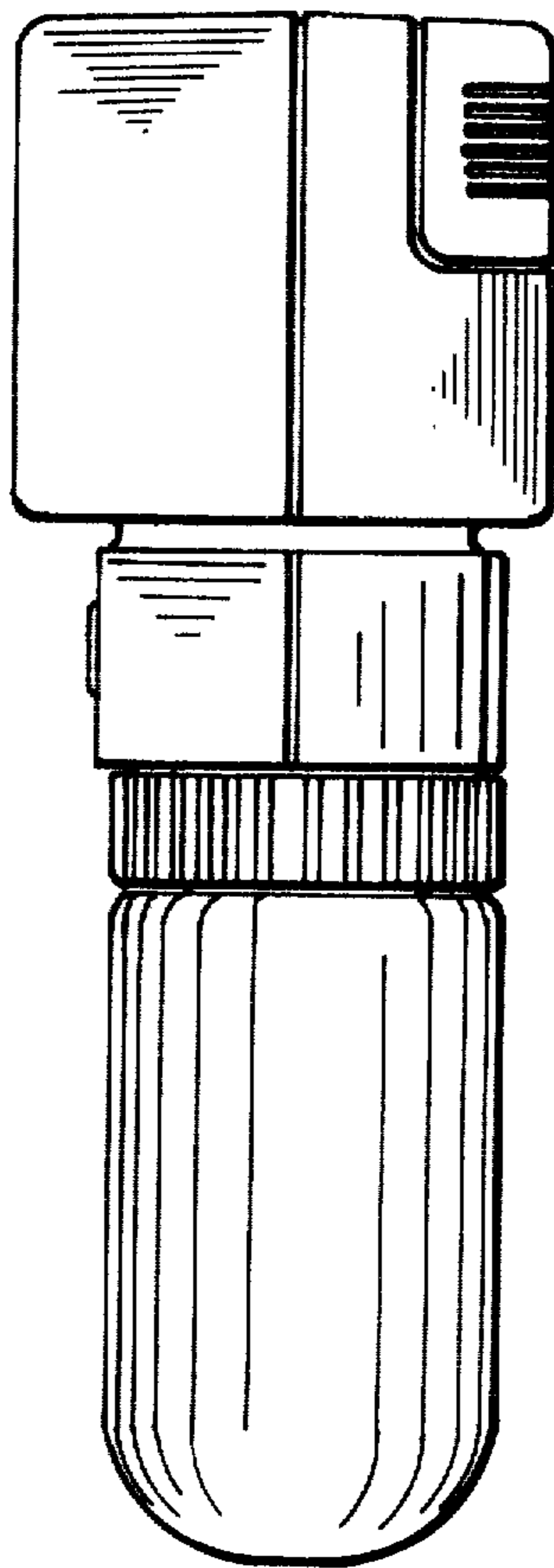

Fig. 10

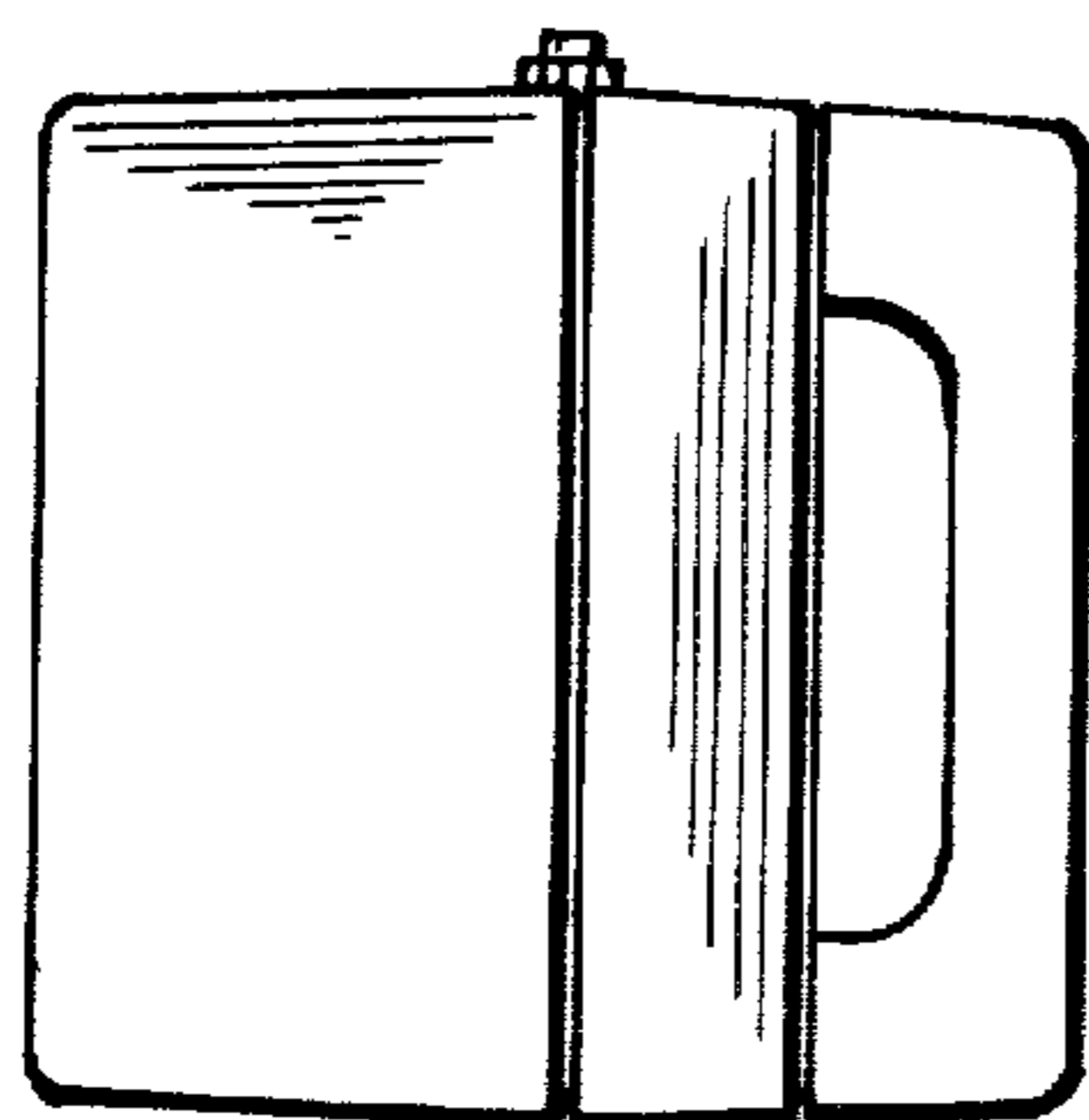

Fig. 11

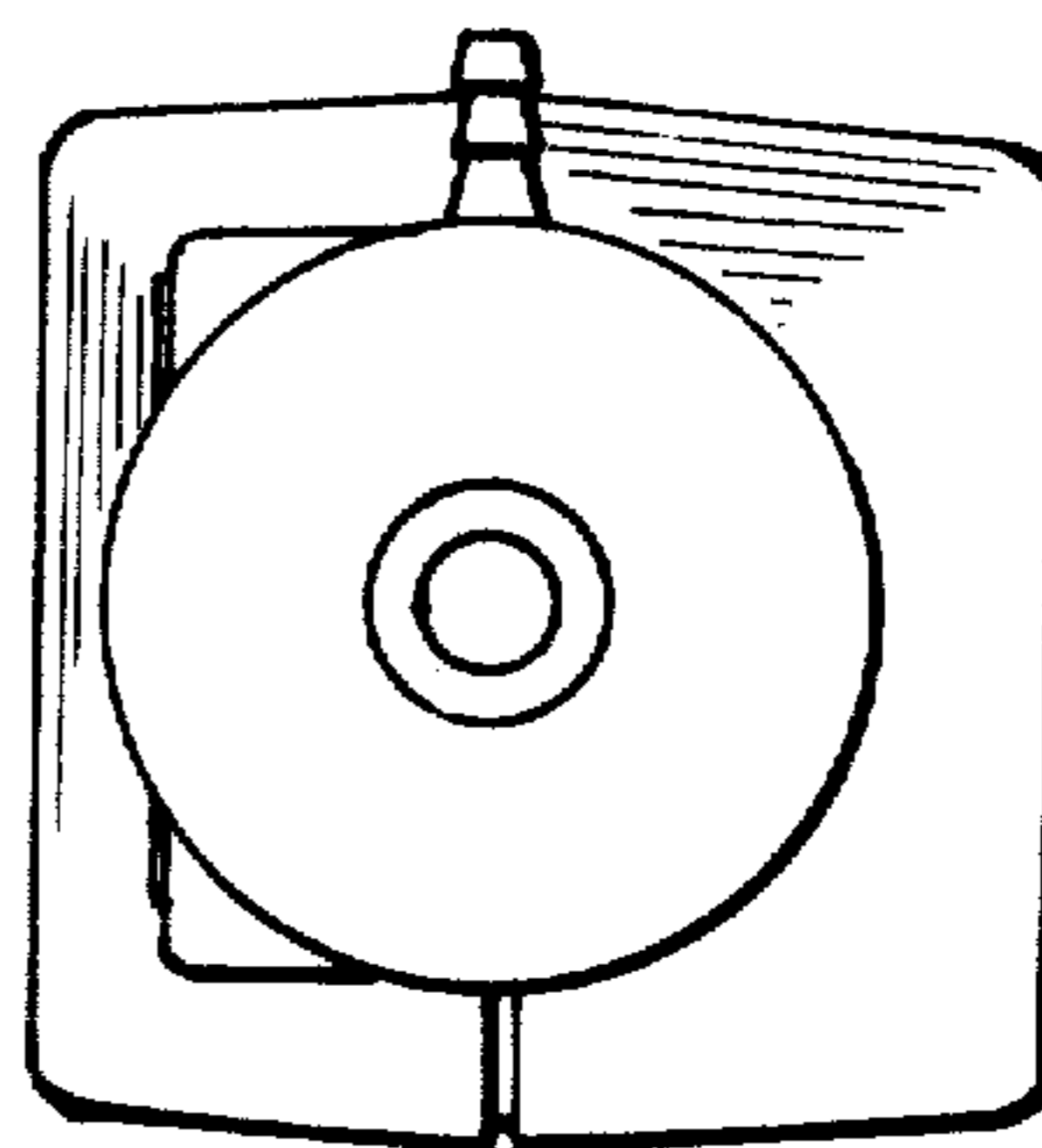

Fig. 12