

[54] ROTATOR PRIMARILY FOR A BARBECUE SPIT

D. 242,759 12/1976 Painter et al. D7/129
2,887,944 5/1959 Walker 99/421 HH

[75] Inventor: Clement S. Wan, Hong Kong, Hong Kong

[73] Assignee: Landman Limited, Hong Kong, Hong Kong

[**] Term: 14 Years

[21] Appl. No.: 74,937

[22] Filed: Sep. 13, 1979

[51] Int. Cl. D7-02

[52] U.S. Cl. D7/402; D7/338

[58] Field of Search D7/107, 108, 109, 110,
D7/129; D13/1-3; 99/419, 420, 421; 310/89,
66

[56] References Cited

U.S. PATENT DOCUMENTS

D. 202,958 11/1965 Cohen et al. D7/110

OTHER PUBLICATIONS

Structo Manufacturing Co. Catalog, pp. 7-8-Swing-A-Way Motor.

Primary Examiner—Catherine E. Kemper
Attorney, Agent, or Firm—Townsend and Townsend

[57] CLAIM

The ornamental design for a rotator primarily for a barbecue spit, as shown.

DESCRIPTION

FIG. 1 is a top plan view of a rotator primarily for a barbecue spit, showing my design;
FIG. 2 is a bottom plan view thereof;
FIG. 3 is an end elevational view thereof;
FIG. 4 is an elevational view of the opposite end thereof;
FIG. 5 is a right side elevational view thereof;
FIG. 6 is a left side elevational view thereof.

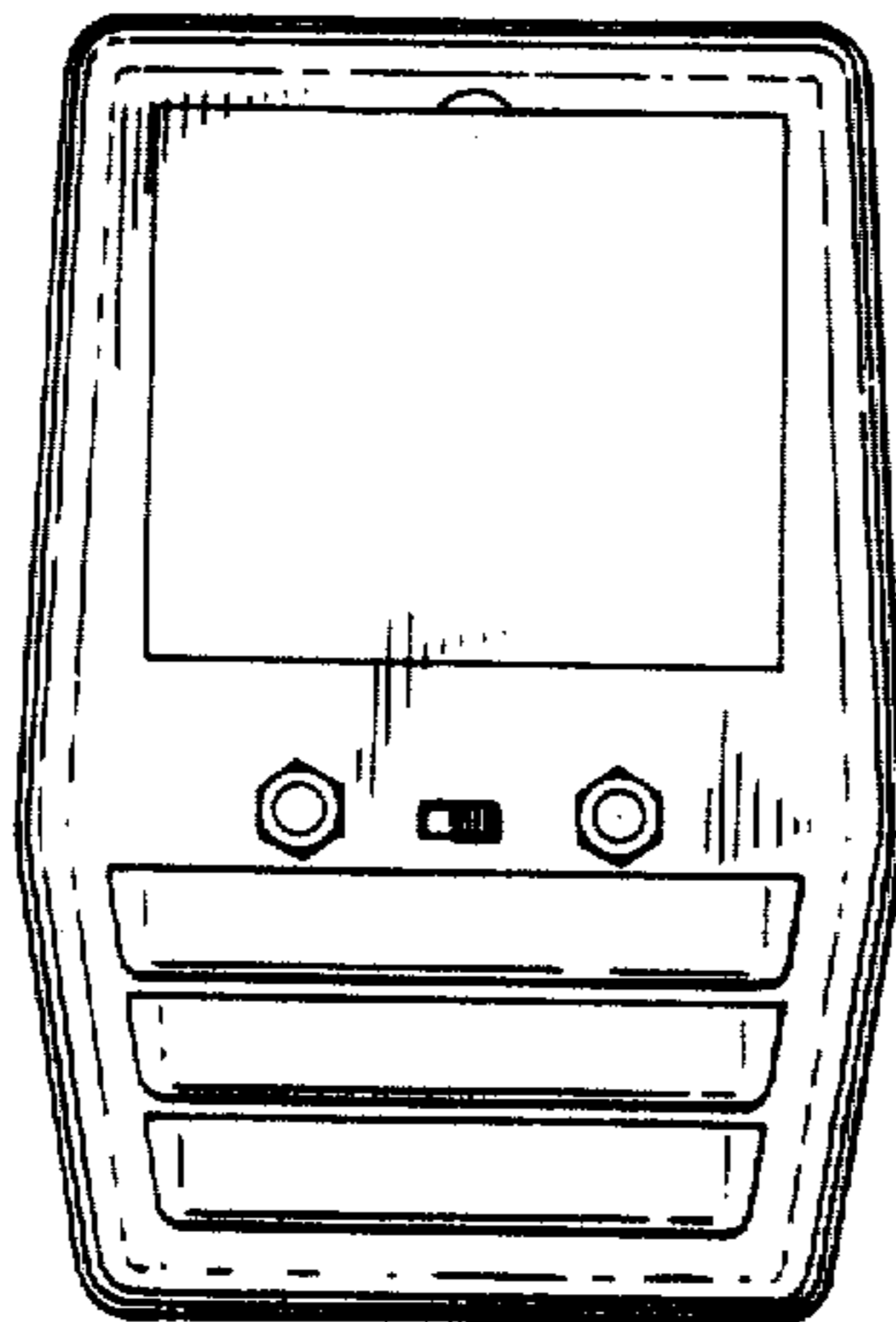
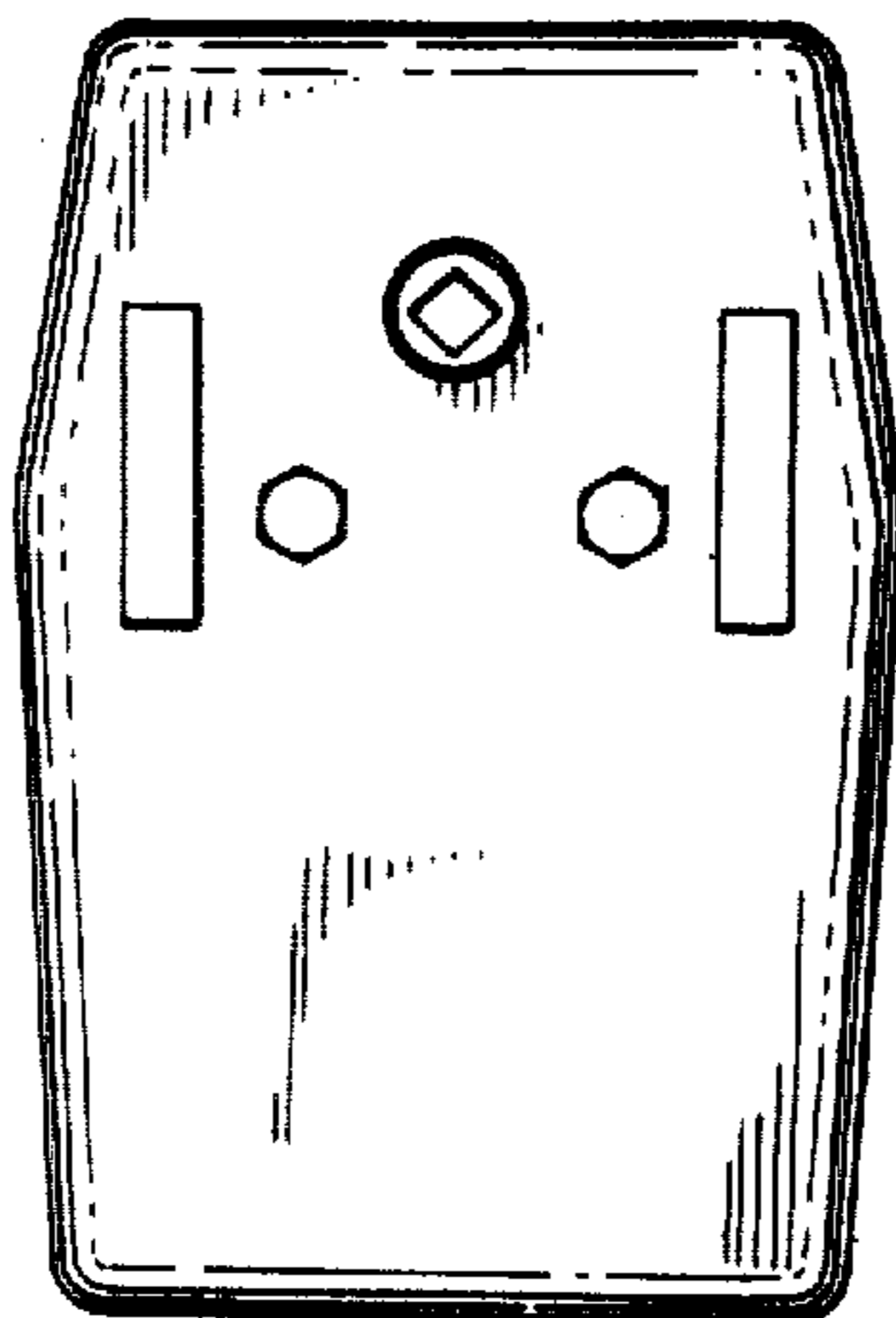

FIG. 1.

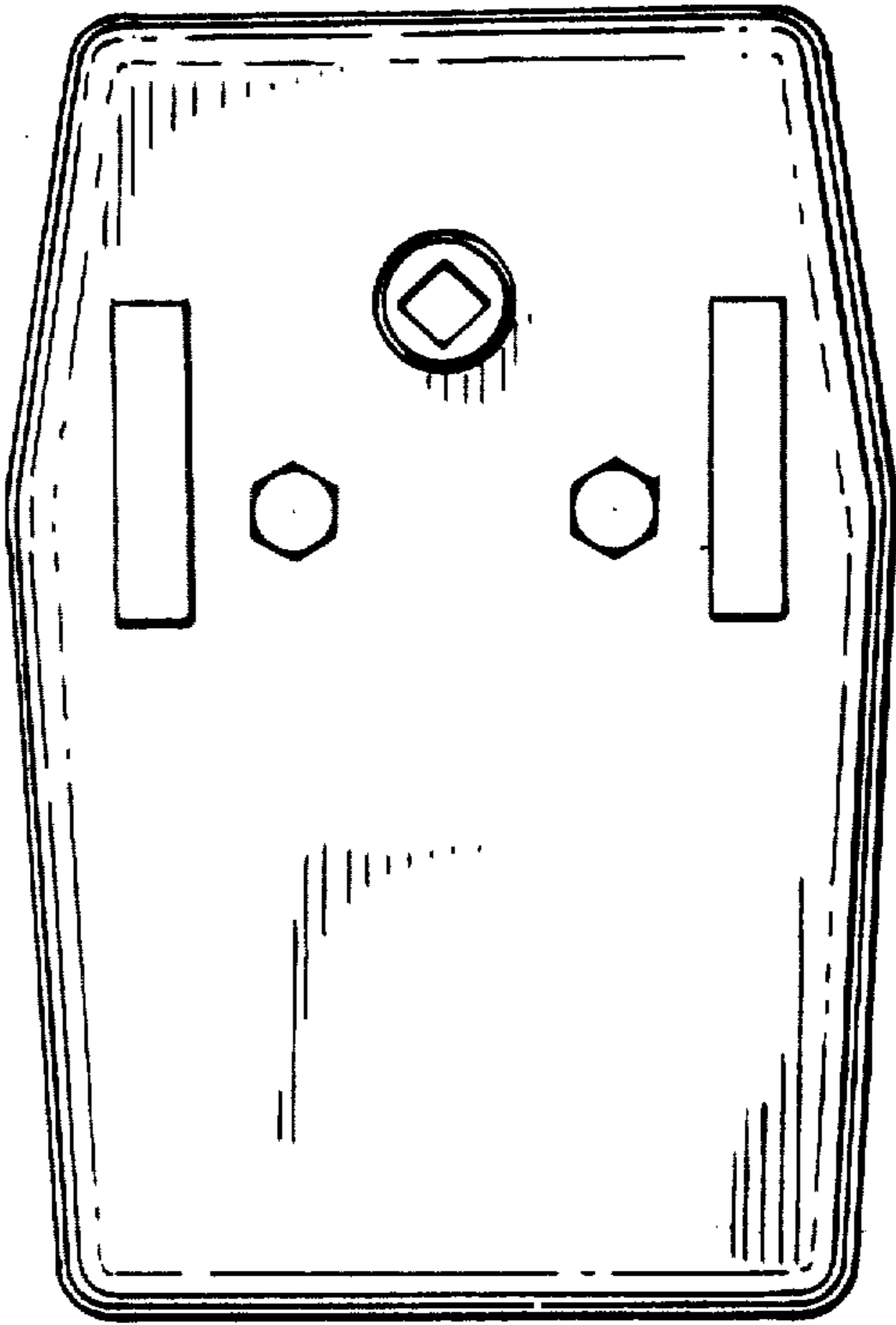

FIG. 2.

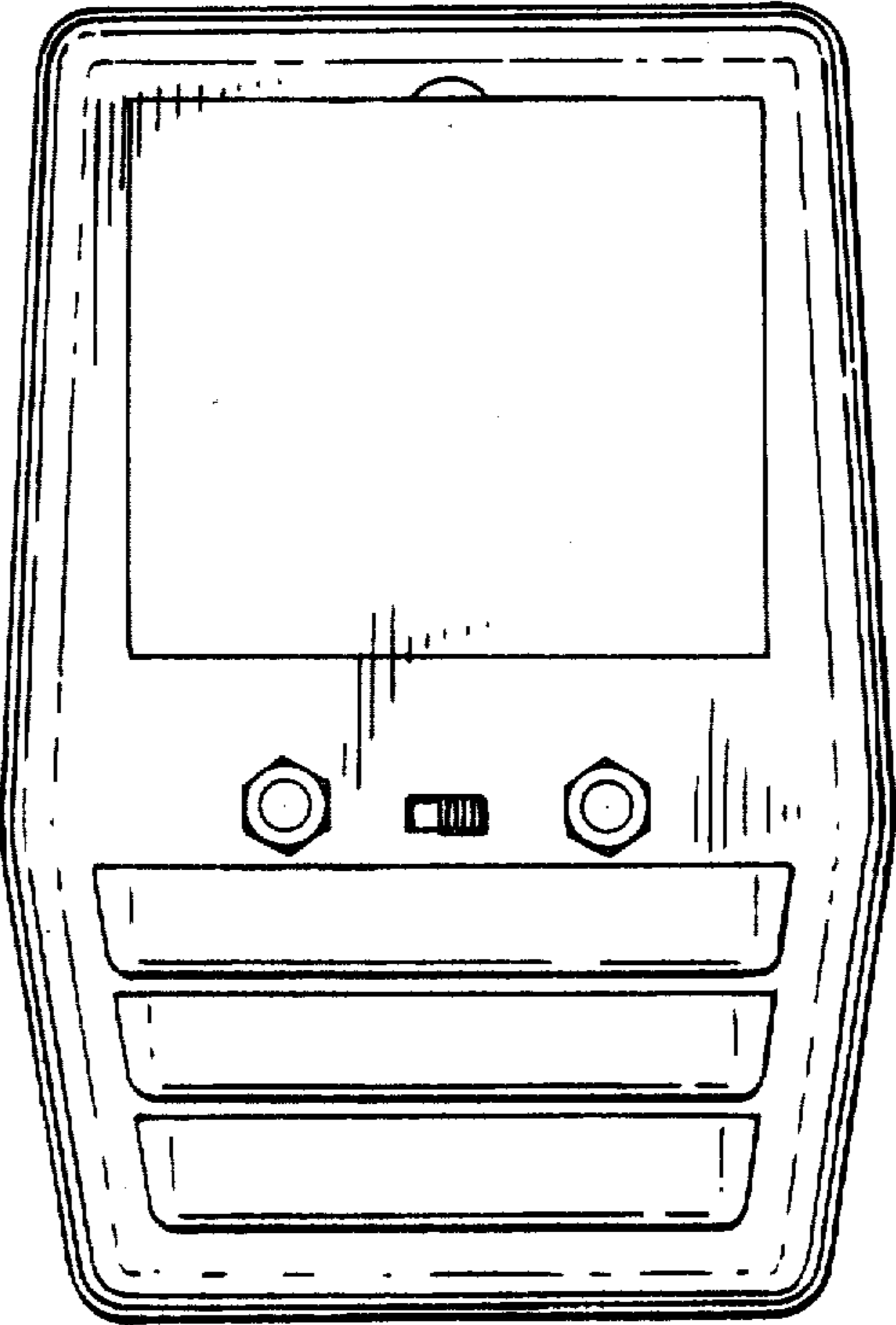

FIG. 3

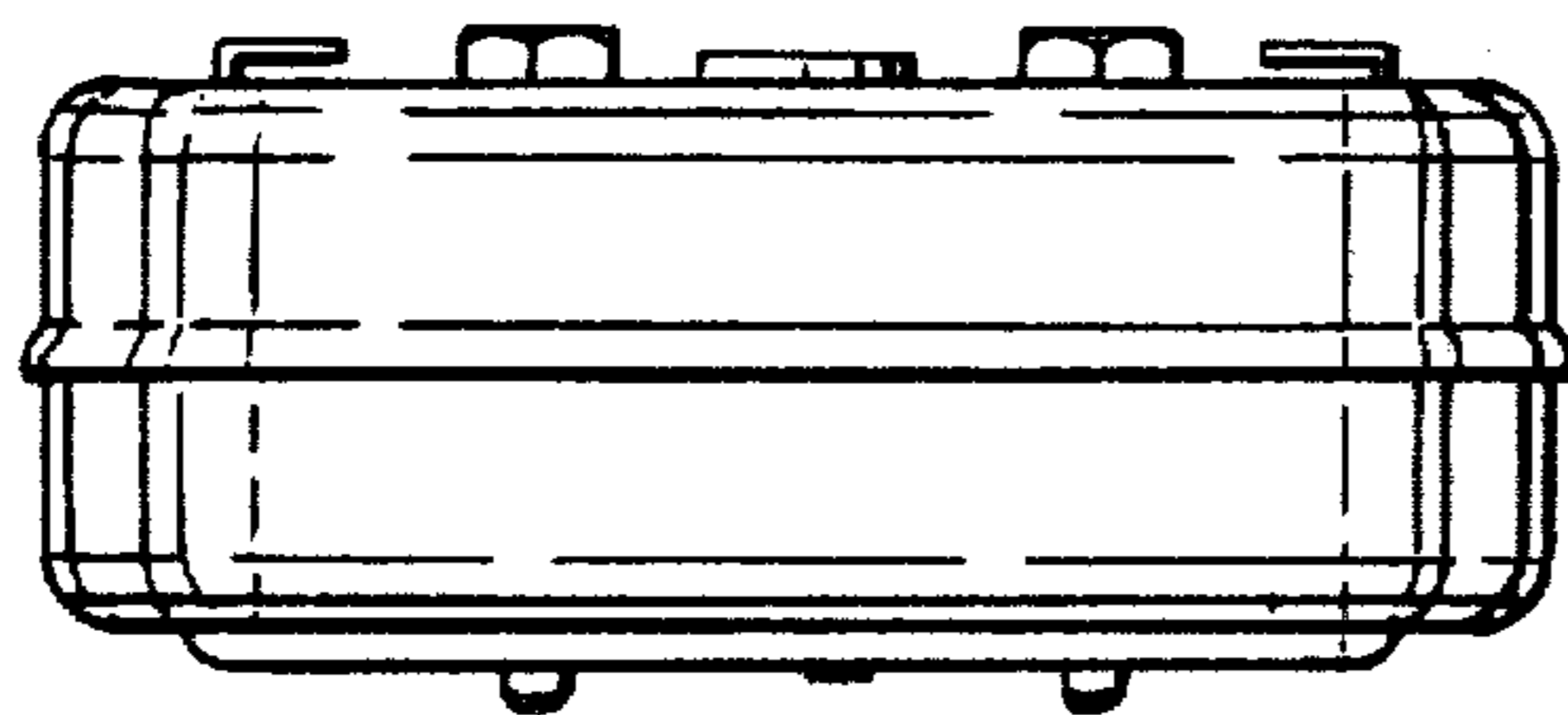
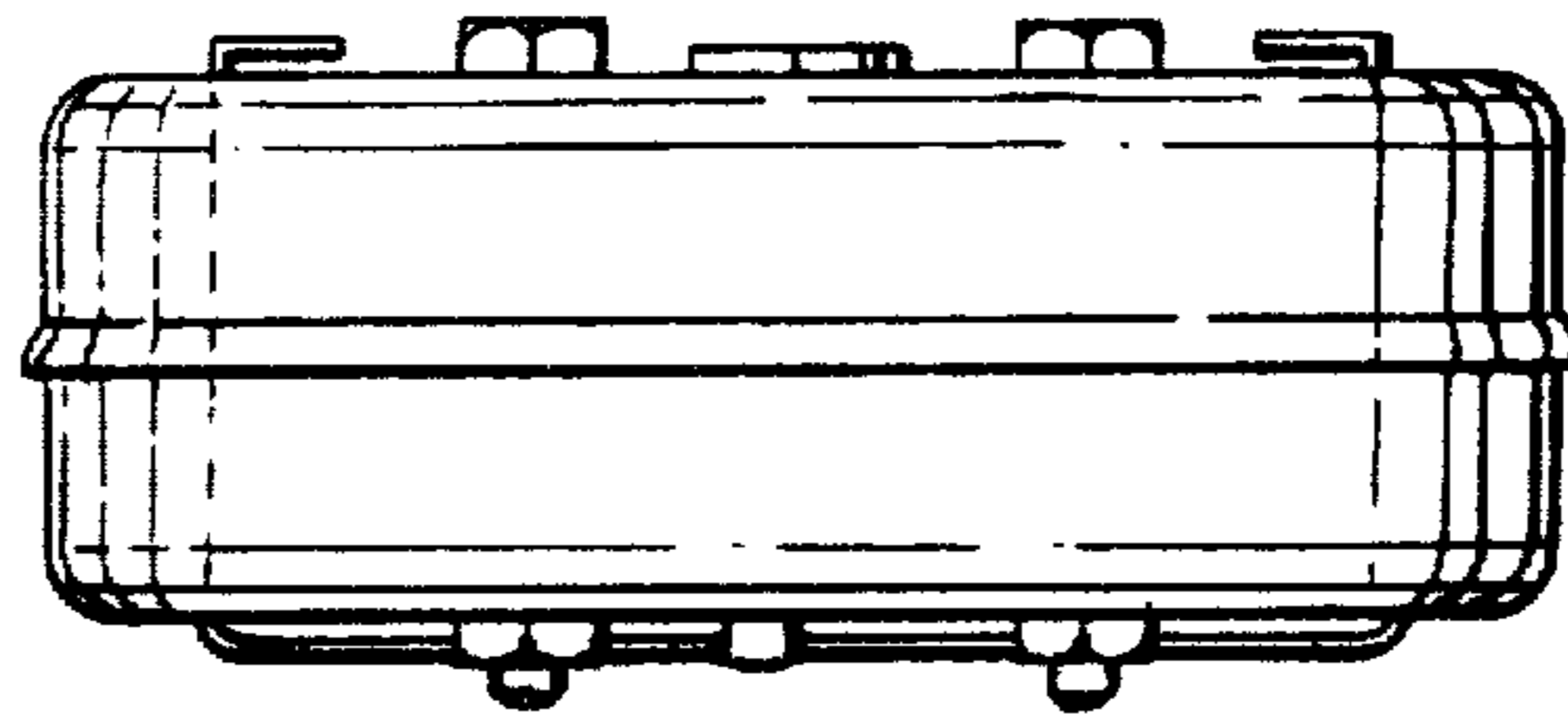

FIG. 4.

FIG. 5.

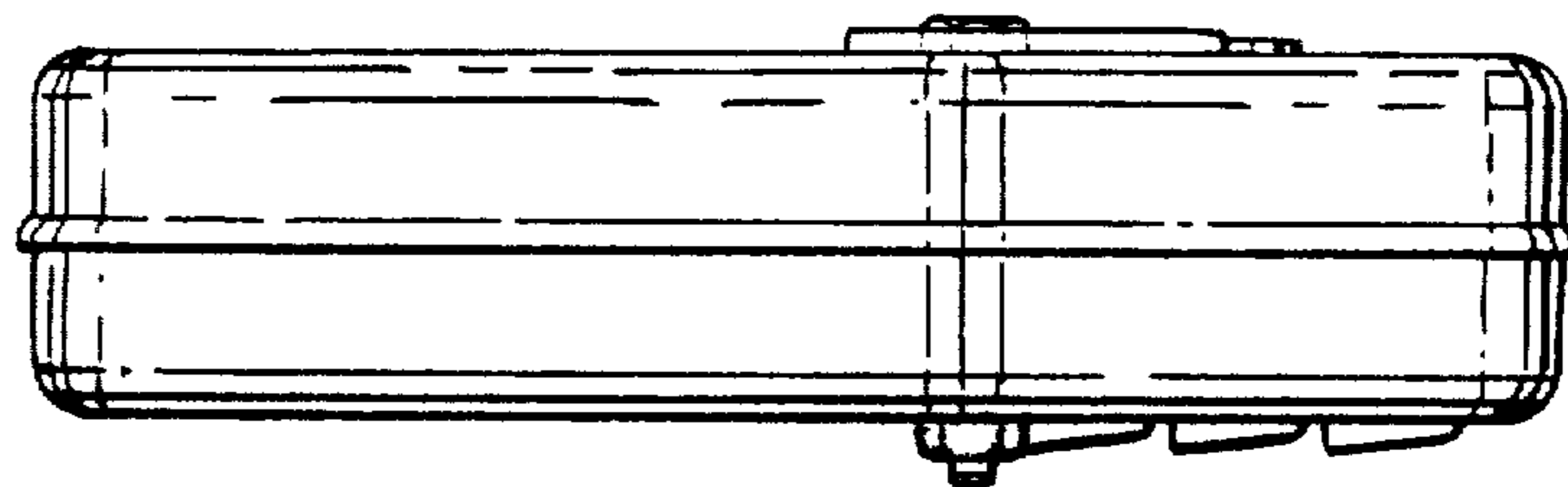

FIG. 6.

