

[54] **GAME TABLE OR SIMILAR ARTICLE**

[76] **Inventor:** Henry Orenstein, 136 Lakeside Ave.,
Verona, N.J. 07044

[**] **Term:** 3½ Years

[21] **Appl. No.:** 148,708

[22] **Filed:** May 12, 1980

[51] **Int. Cl.** D6—03

[52] **U.S. Cl.** D6/152; D21/14

[58] **Field of Search** D6/5, 11, 12, 146, 151-154,
D6/177, 178, 179, 181, 188; D21/14

[56] **References Cited**

U.S. PATENT DOCUMENTS

- D. 75,912 7/1928 Hauser D6/152
- D. 76,615 10/1928 Heyman D6/152
- D. 81,528 7/1930 Conboy D6/152
- D. 217,792 6/1970 Shrode, Jr. D6/152

1,539,198 5/1925 Marsh D21/14 X

OTHER PUBLICATIONS

Interiors, 8/72, p. 107, Table top right.

Primary Examiner—Bruce W. Dunkins
Attorney, Agent, or Firm—Gottlieb, Rackman &
Reisman

[57] **CLAIM**

The ornamental design for a game table or similar article, as shown and described.

DESCRIPTION

FIG. 1 is a perspective view of a game table or similar article showing my new design;
FIG. 2 is a top plan view of the design;
FIG. 3 is a front view of the design;
FIG. 4 is a left side view of the design;
FIG. 5 is a rear view of the design;
FIG. 6 is a right side view of the design; and
FIG. 7 is a bottom plan view of the design.

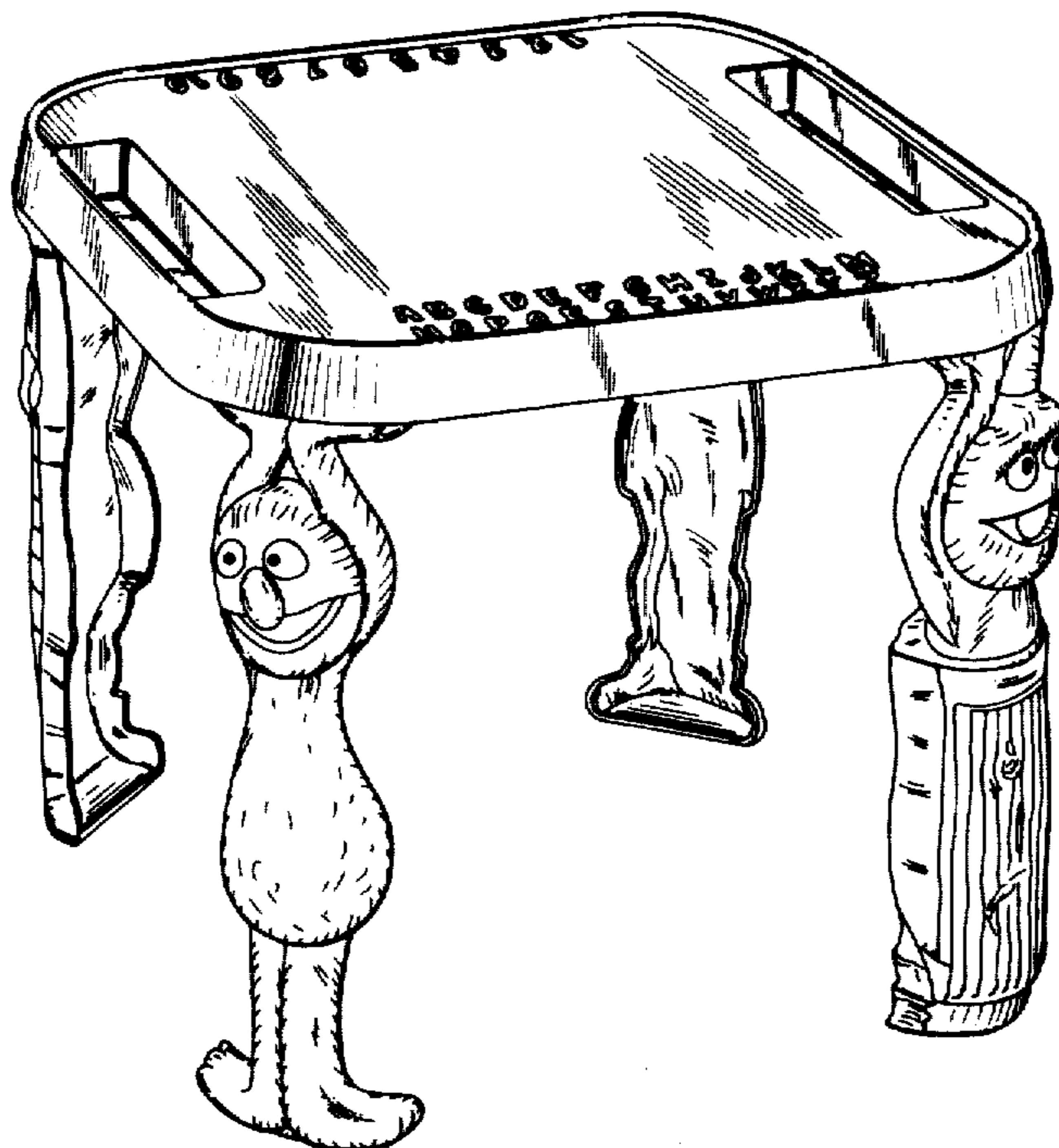

FIG. 1

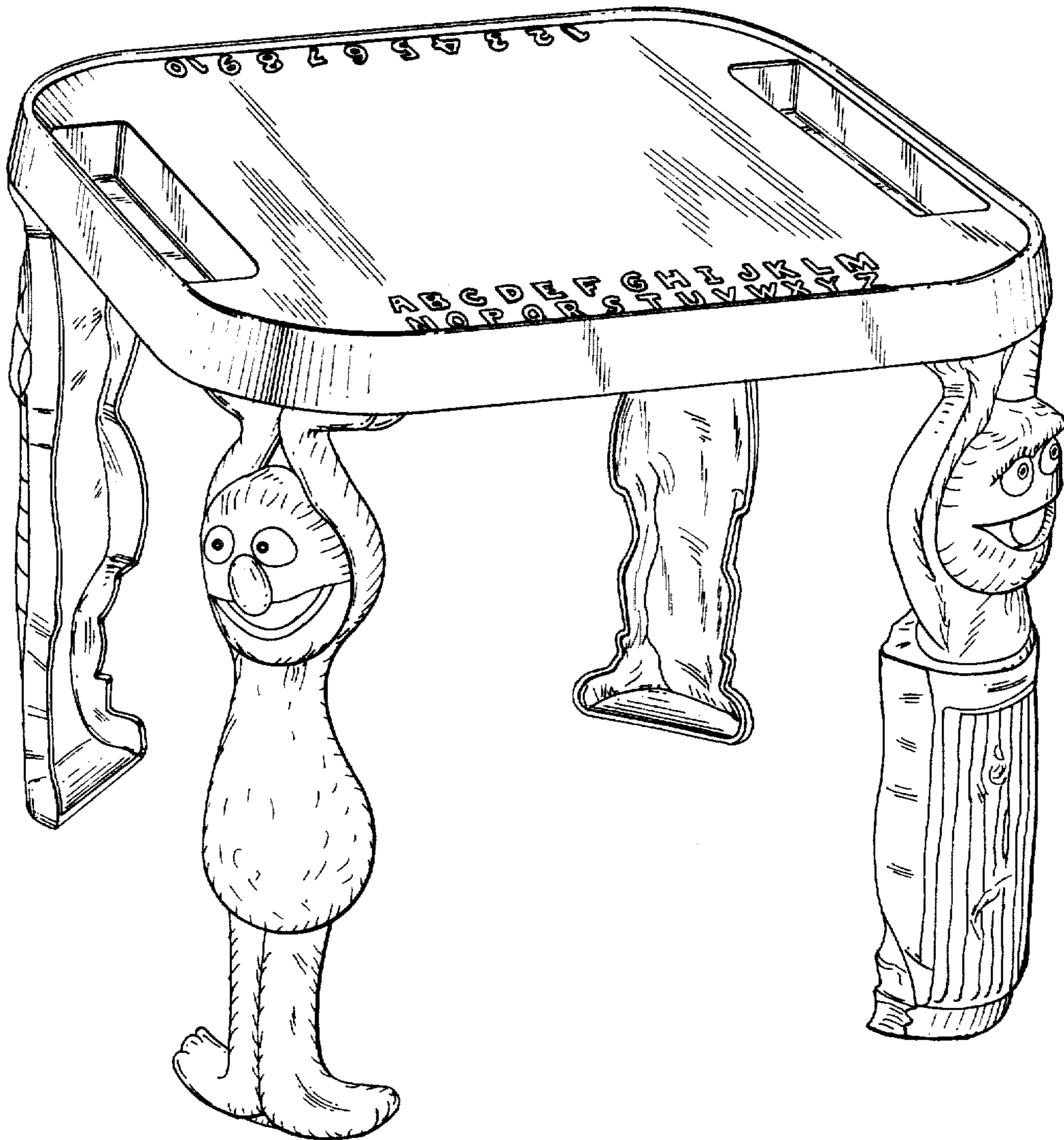

FIG. 2

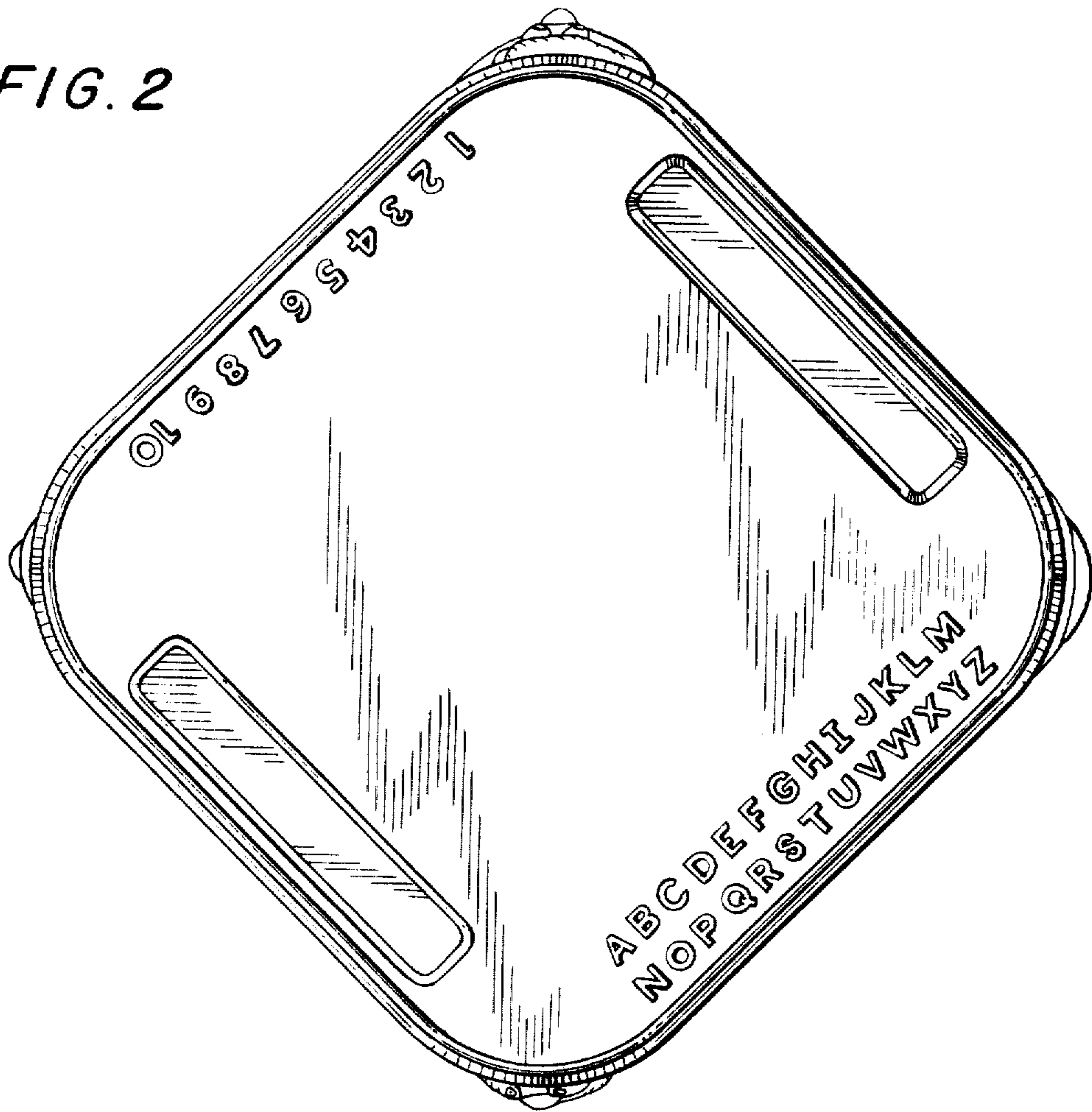

FIG. 3

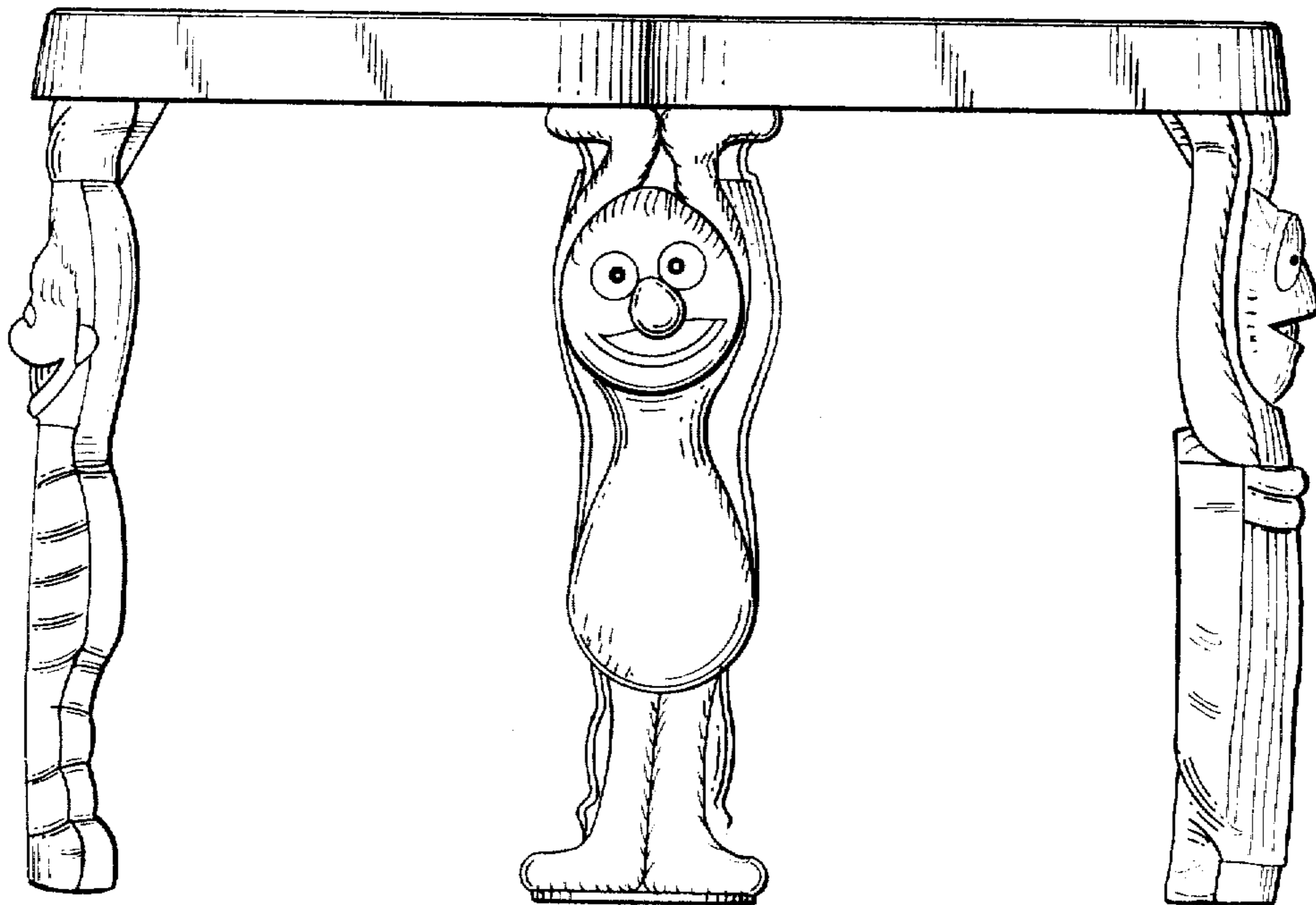

FIG. 4

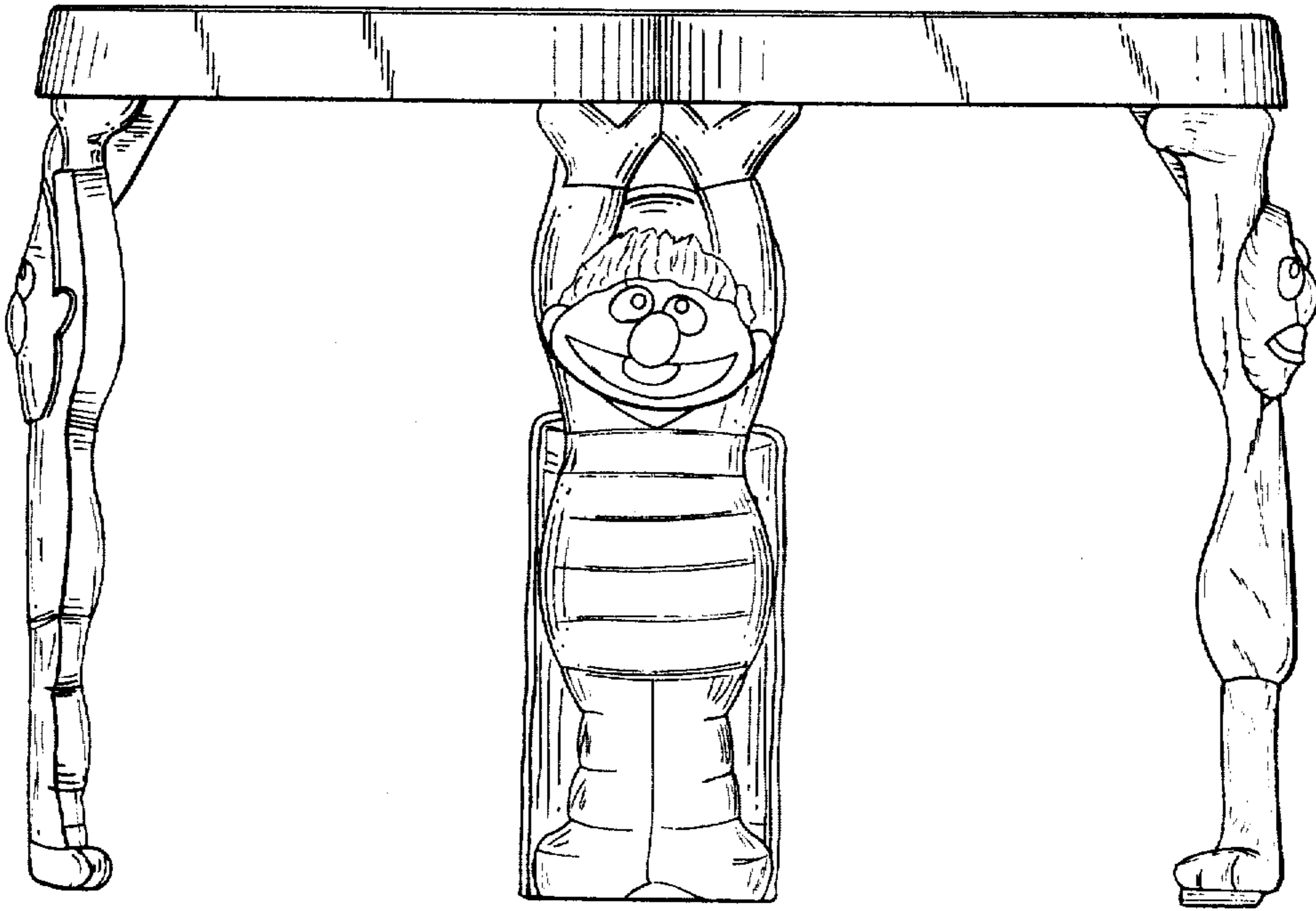

FIG. 5

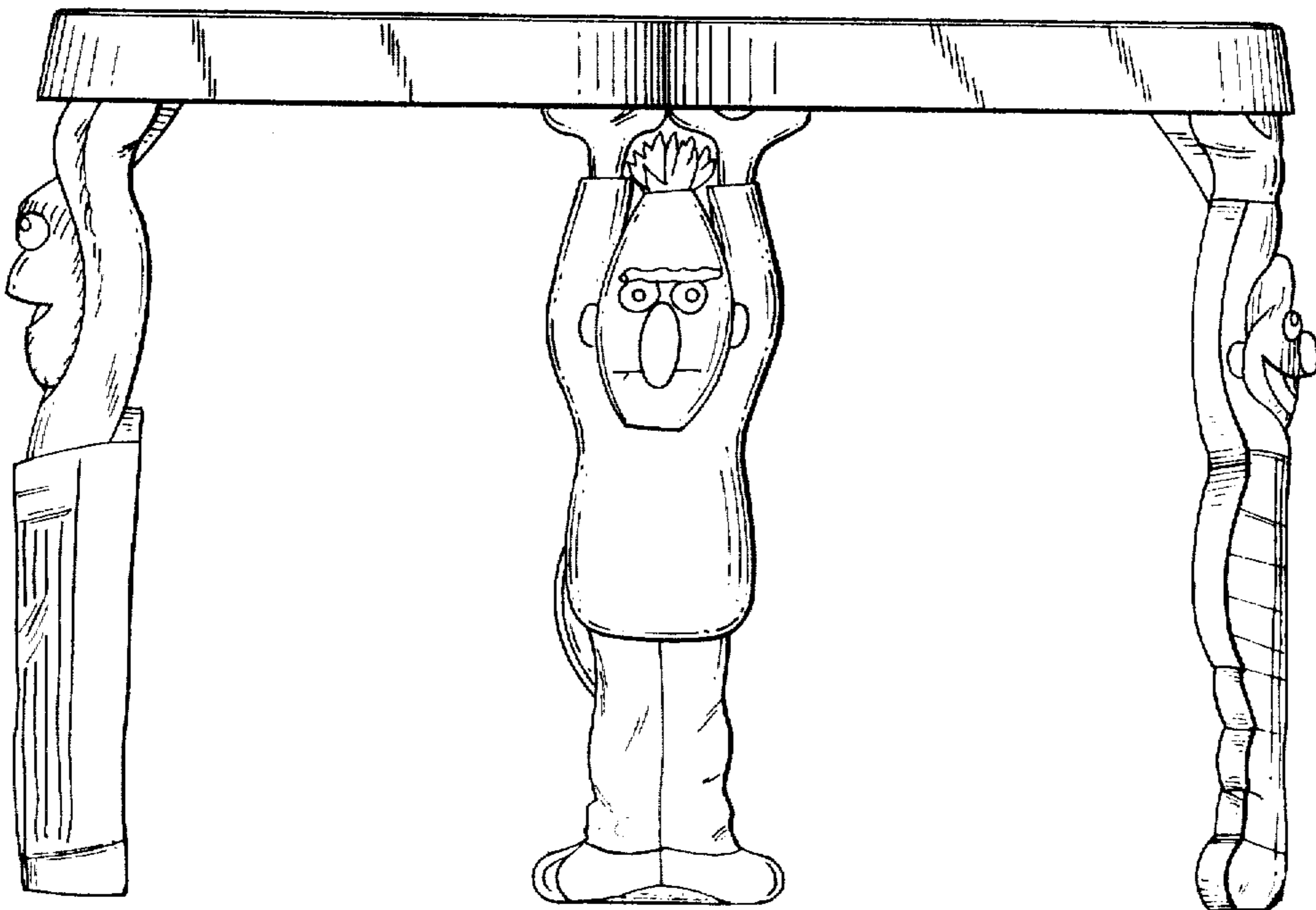

FIG. 6

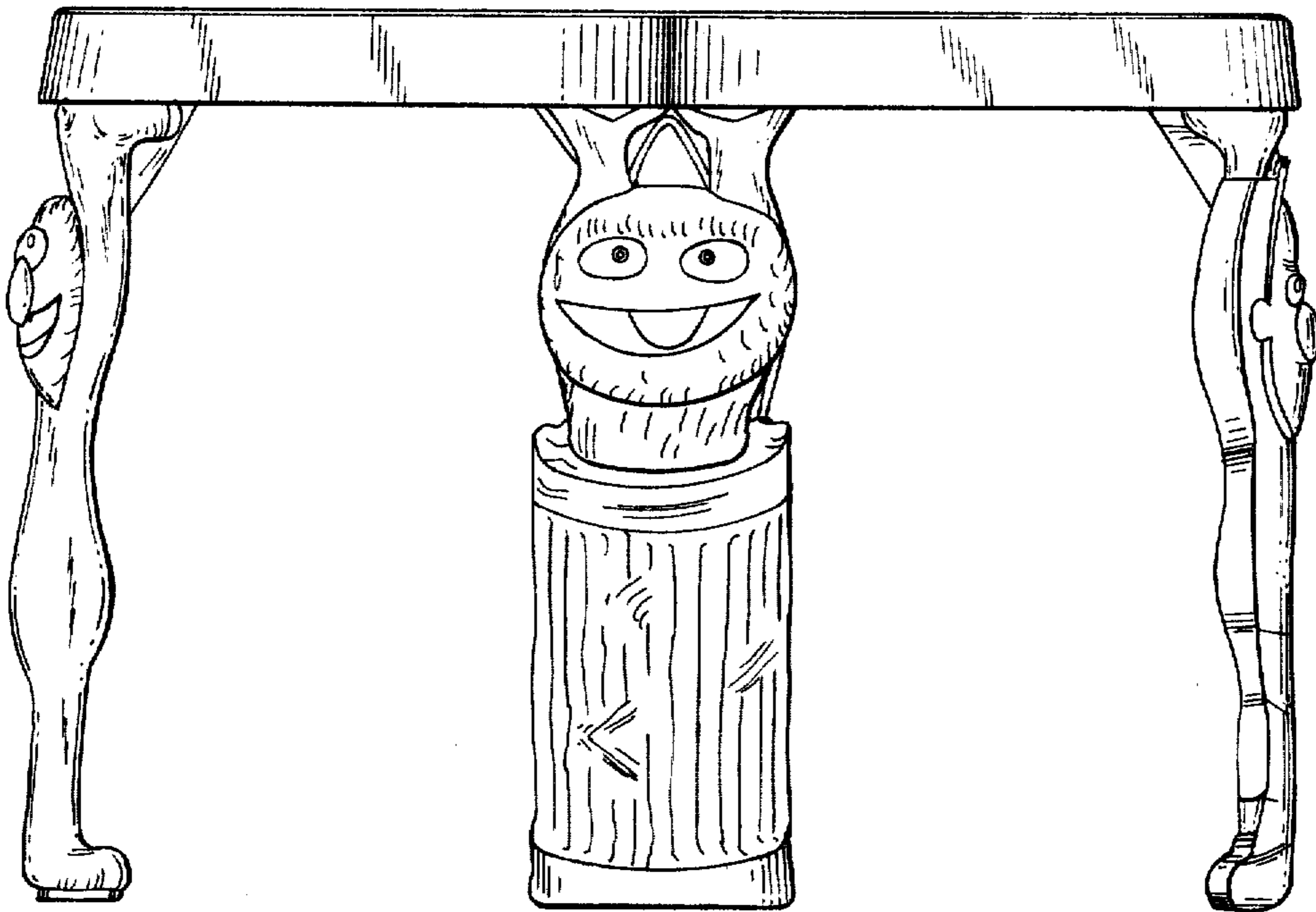

FIG. 7

