

[54] H-SHAPED WINDOW FRAME MEMBER

[76] Inventor: Marvin L. Goldhaber, 5102 Rock Run, West Bloomfield, Mich. 48033

[**] Term: 14 Years

[21] Appl. No.: 204,603

[22] Filed: Nov. 6, 1980

[51] Int. Cl. D25-01

[52] U.S. Cl. D25/74

[58] Field of Search D25/74-79;
160/90; 49/413, 419, 501; 52/202

[56] References Cited

U.S. PATENT DOCUMENTS

D. 251,133 2/1979 Bancroft et al. D25/74

D. 251,444 3/1979 Bancroft et al. D25/74
4,175,357 11/1979 Goldhaber 49/395

Primary Examiner—A. Hugo Word
Attorney, Agent, or Firm—Basile, Weintraub & Hanlon

[57] CLAIM

The ornamental design for an H-shaped window frame member, as shown.

DESCRIPTION

FIG. 1 is a front perspective view illustrating an H-shaped window frame member showing my new design; FIG. 2 is a front elevational view thereof; FIG. 3 is a left-end elevational view of FIG. 2; FIG. 4 is a right-end elevational view of FIG. 2; FIG. 5 is a top elevational view thereof; FIG. 6 is a bottom elevational view thereof; and FIG. 7 is a rear elevational view thereof.

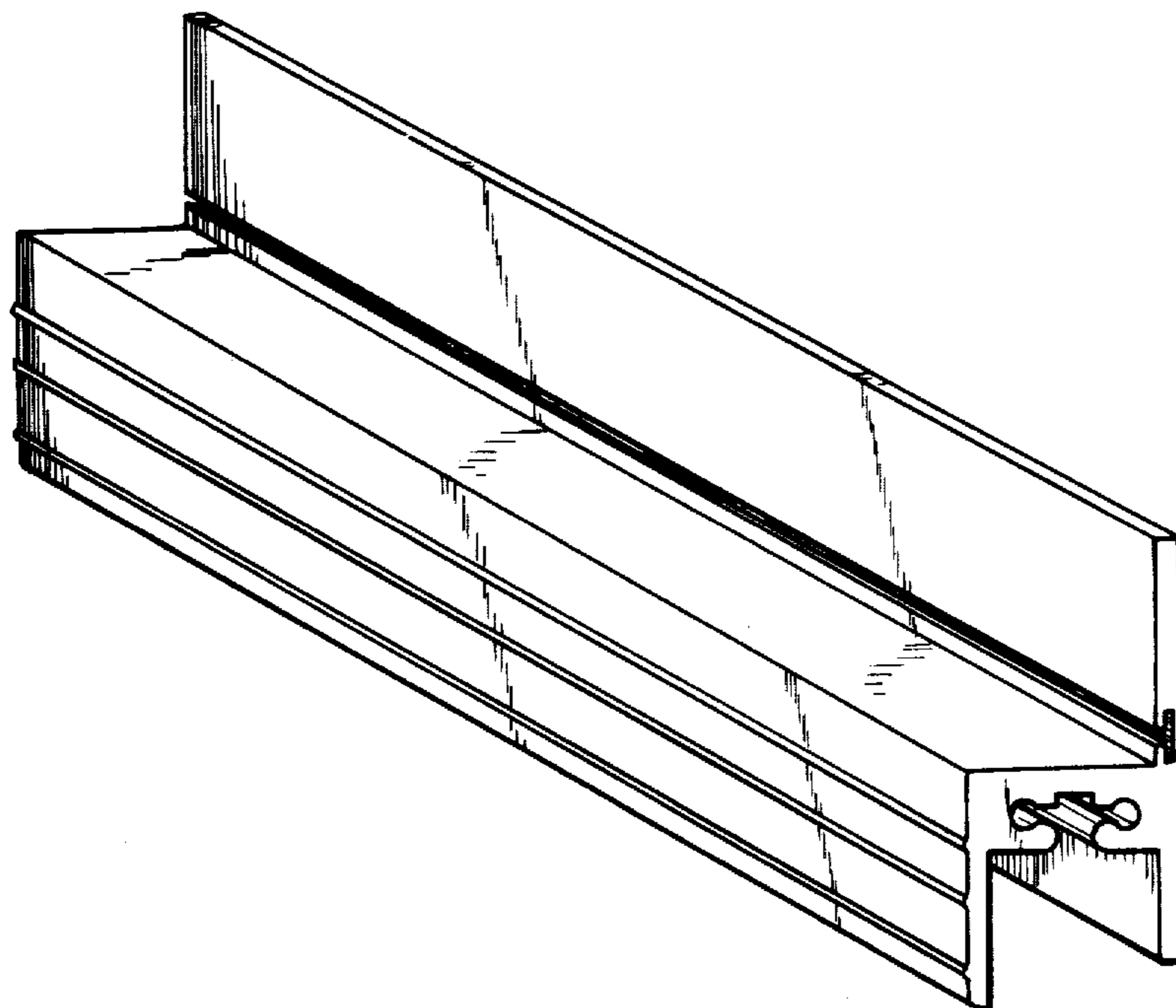

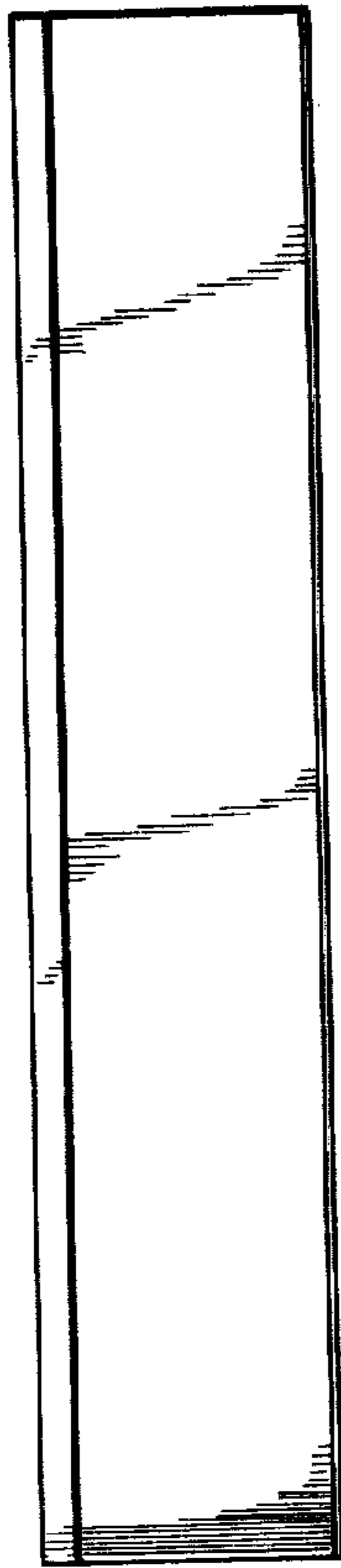

Fig-5

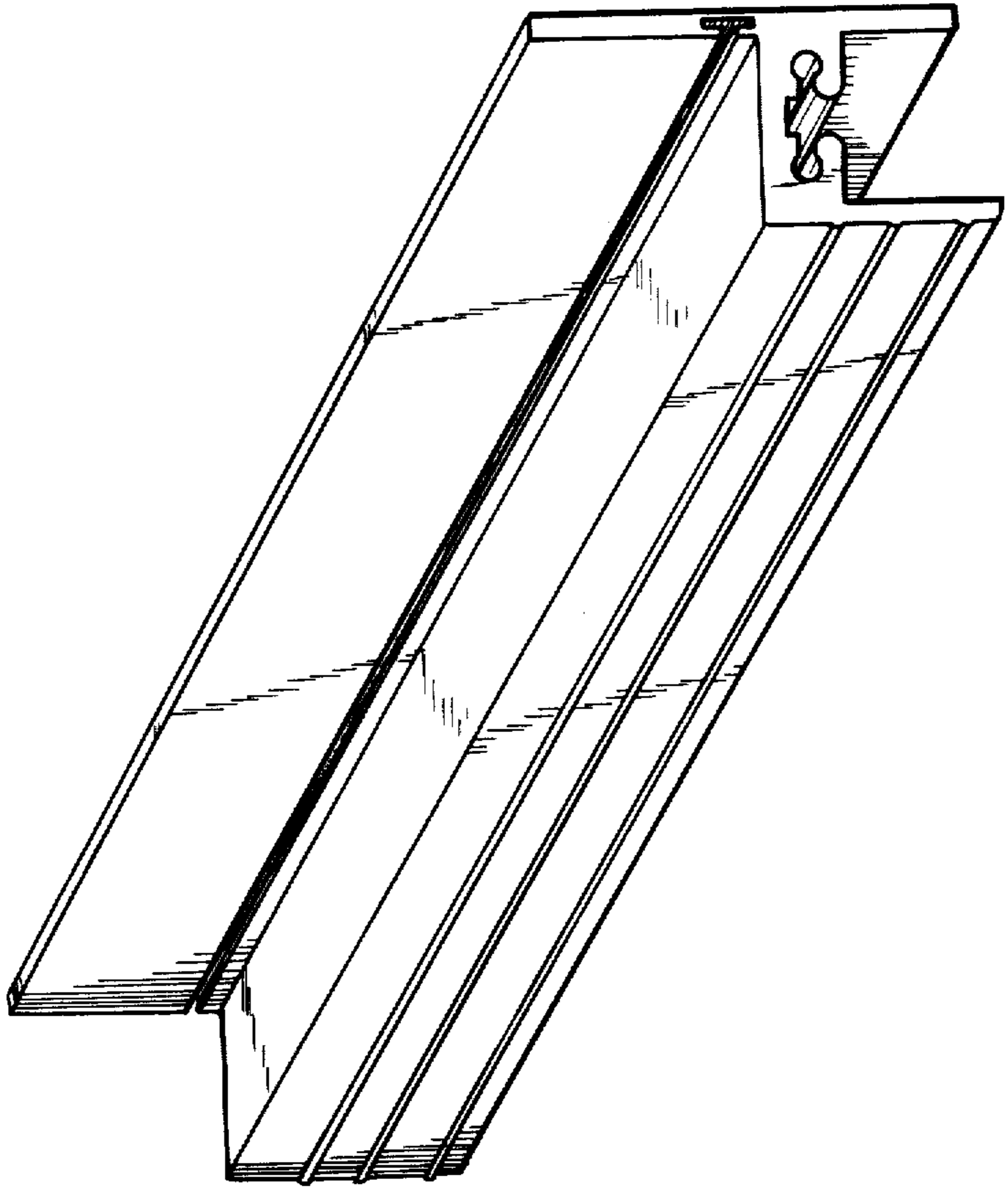

Fig-1

Fig - 4

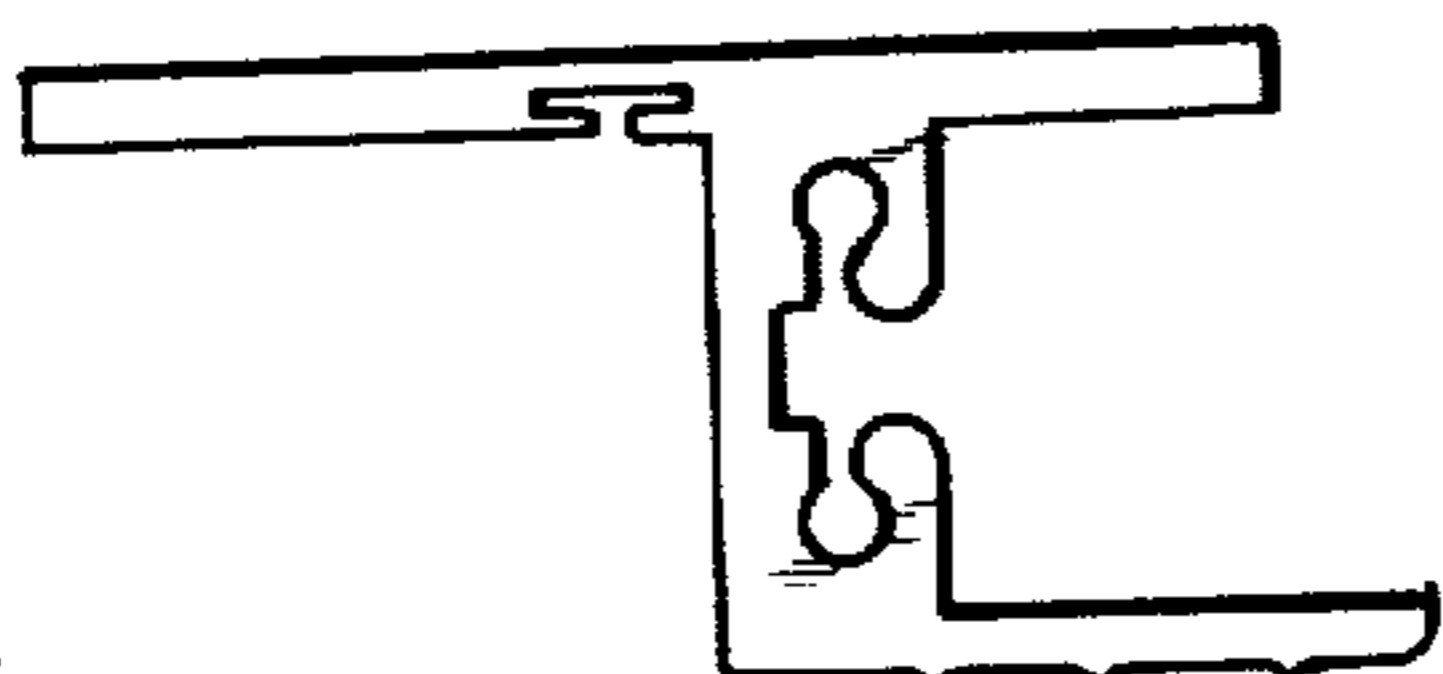

Fig - 6

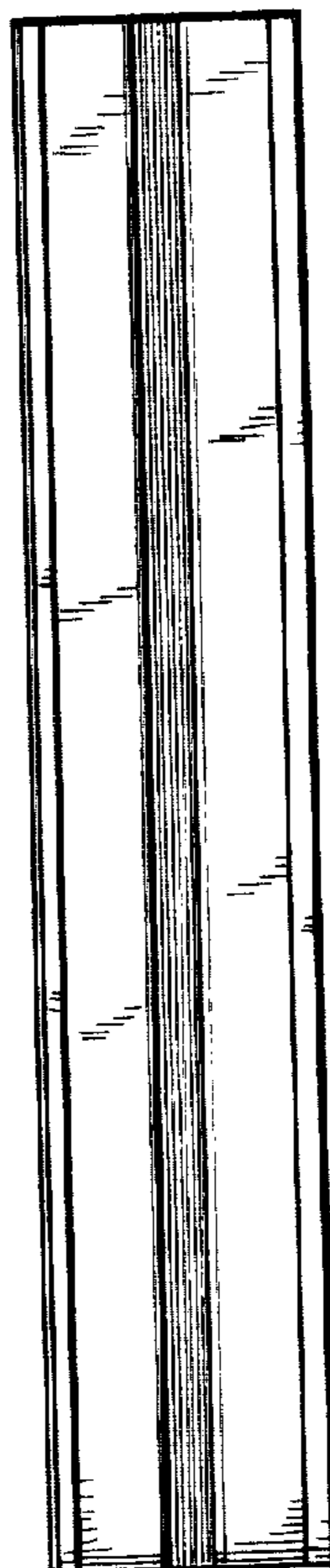

Fig - 7

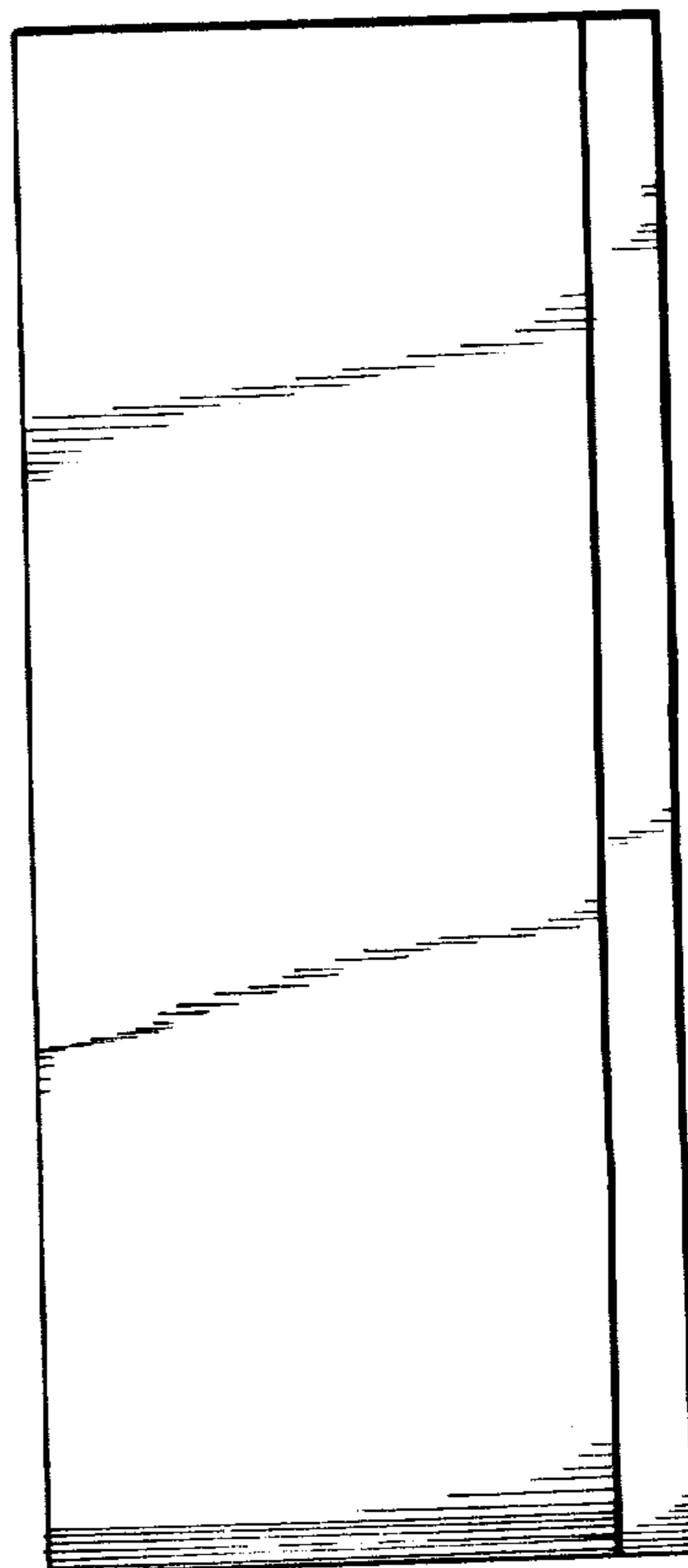

Fig - 2

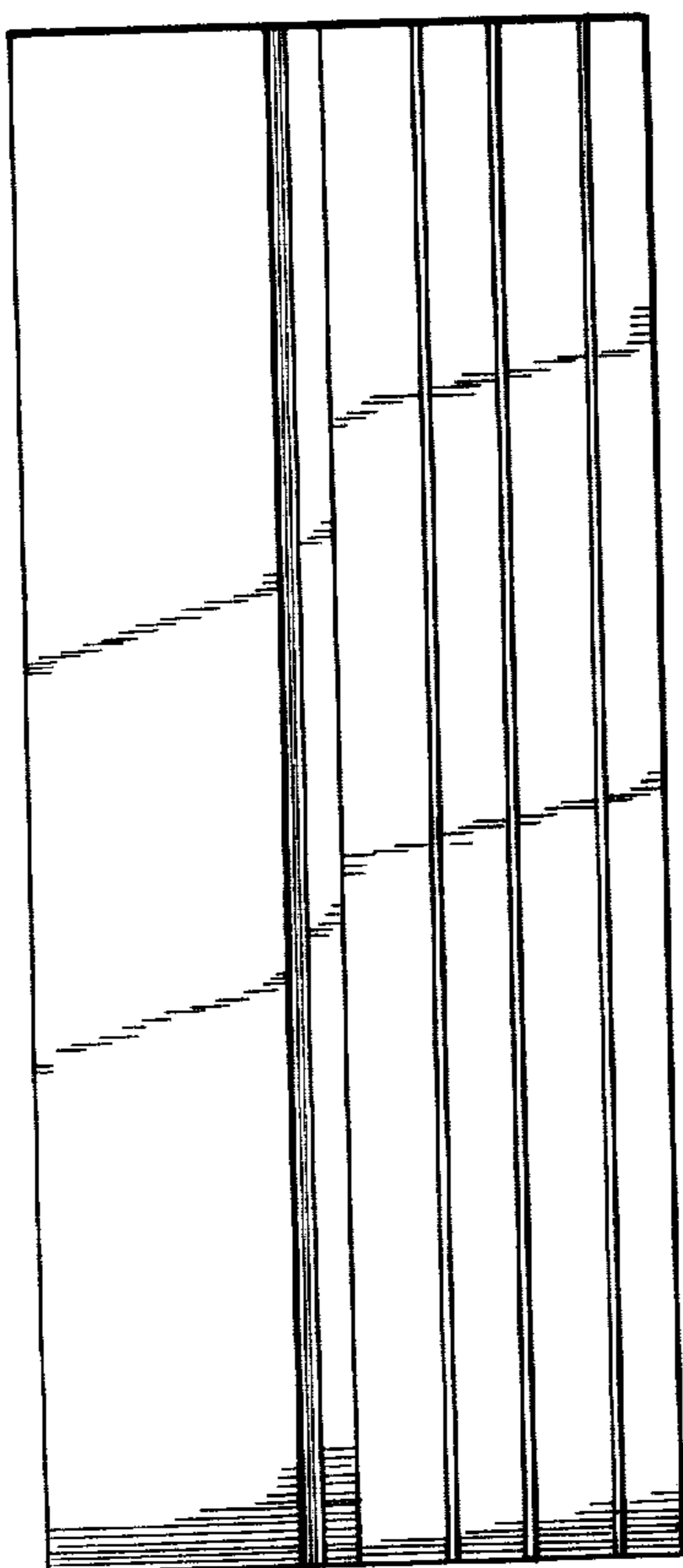

Fig - 3

