

[54] **Z-SHAPED WINDOW FRAME MEMBER**

[76] **Inventor:** Marvin L. Goldhaber, 5102 Rock Run, West Bloomfield, Mich. 48033

[\*\*] **Term:** 14 Years

[21] **Appl. No.:** 204,602

[22] **Filed:** Nov. 6, 1980

[51] **Int. Cl.** ..... D25-01

[52] **U.S. Cl.** ..... D25/74

[58] **Field of Search** ..... D25/74-79;  
160/90; 49/413, 419, 501; 52/202

[56] **References Cited**

**U.S. PATENT DOCUMENTS**

D. 251,133 2/1979 Bancroft et al. .... D25/74

D. 251,444 3/1979 Bancroft et al. .... D25/74  
4,175,357 11/1979 Goldhaber ..... 49/395

*Primary Examiner*—A. Hugo Word  
*Attorney, Agent, or Firm*—Basile, Weintraub & Hanlon

[57] **CLAIM**

The ornamental design for a Z-shaped window frame member, as shown.

**DESCRIPTION**

FIG. 1 is a front perspective view illustrating a Z-shaped window frame member showing my new design; FIG. 2 is a front elevational view thereof; FIG. 3 is a left-end elevational view of FIG. 2; FIG. 4 is a right-end elevational view of FIG. 2; FIG. 5 is a top elevational view thereof; FIG. 6 is a bottom elevational view thereof; and FIG. 7 is a rear elevational view thereof.

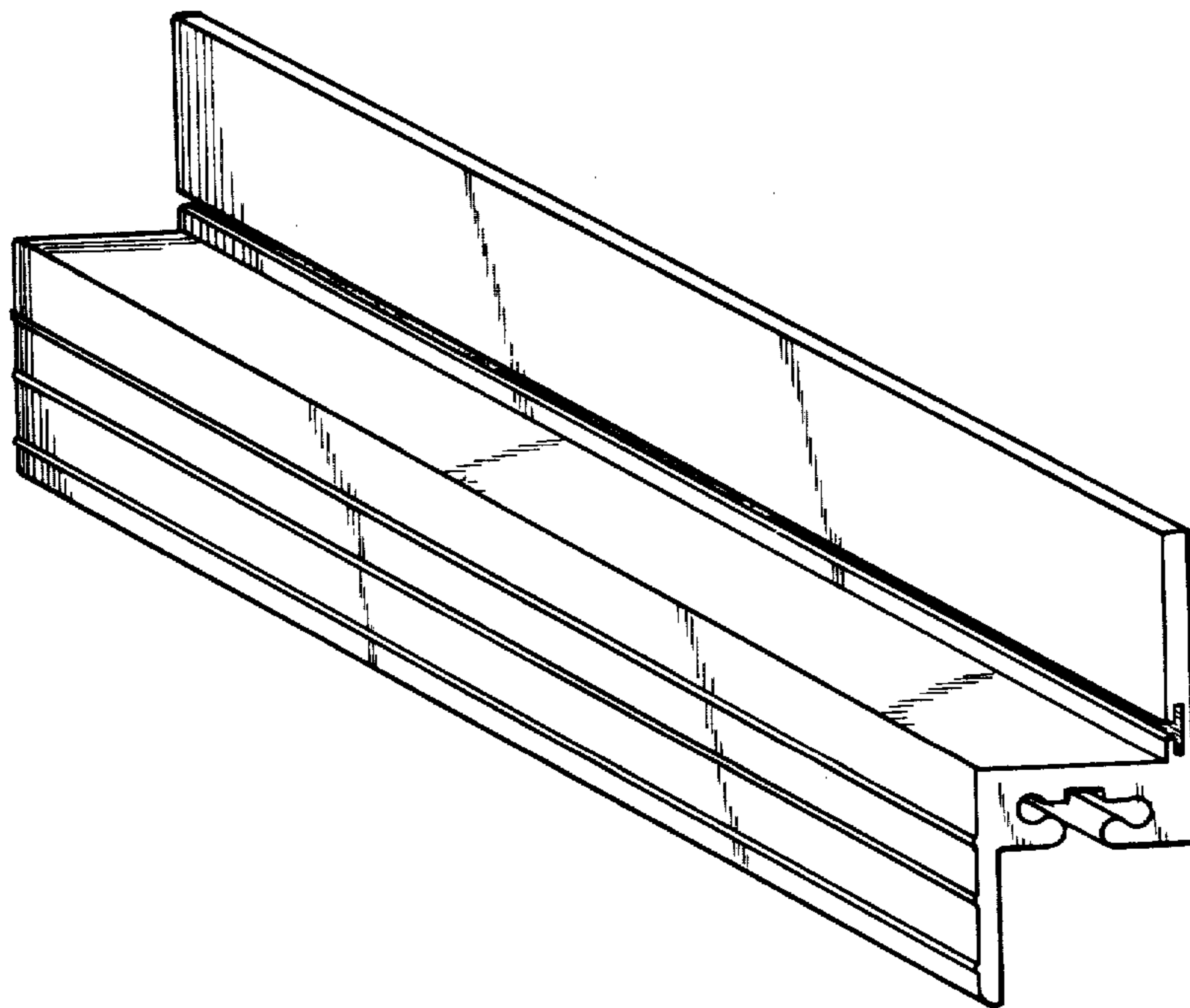

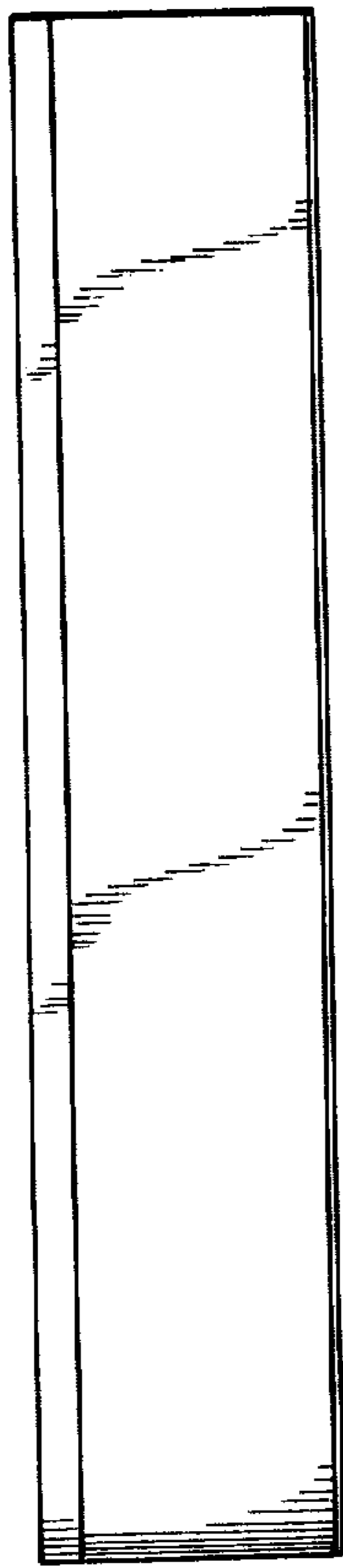

Fig-5

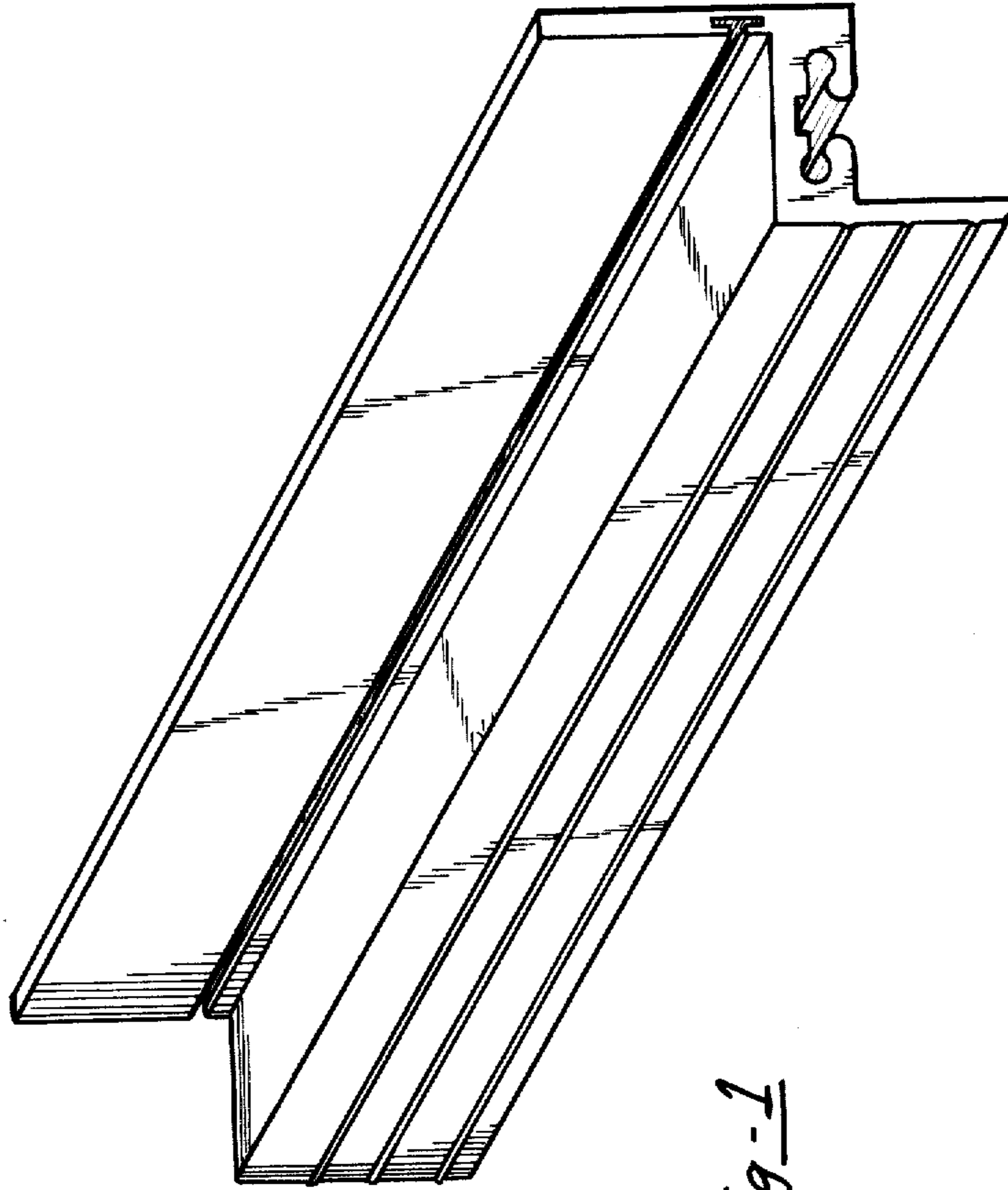

Fig-1

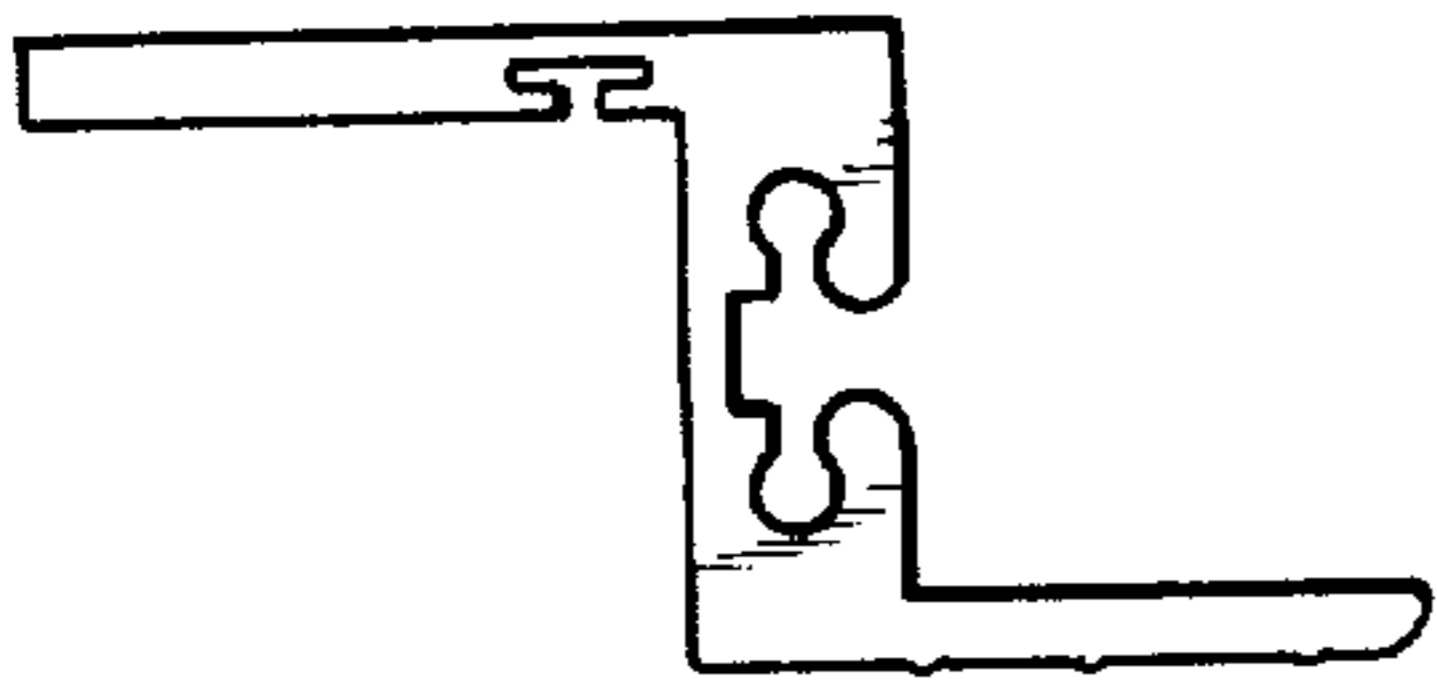

Fig-4

Fig-2

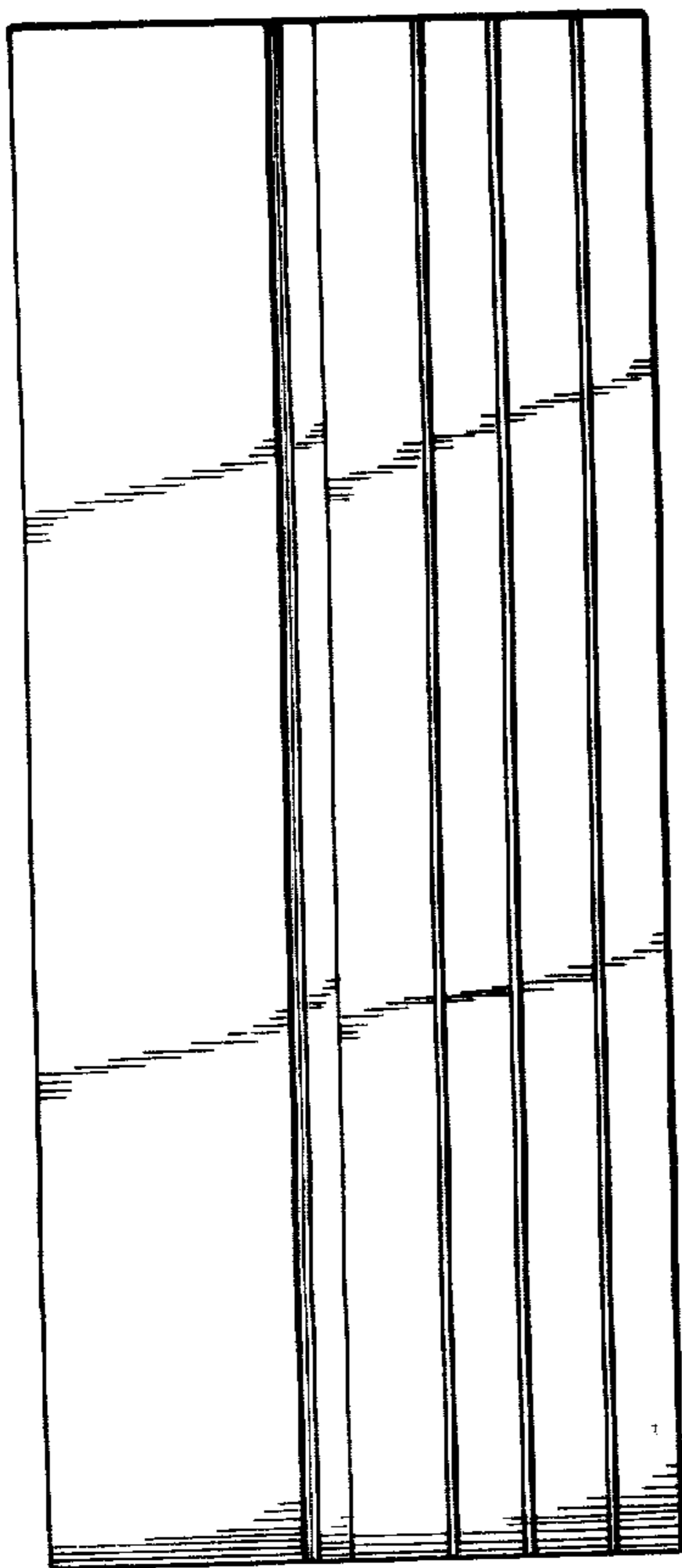

Fig-6

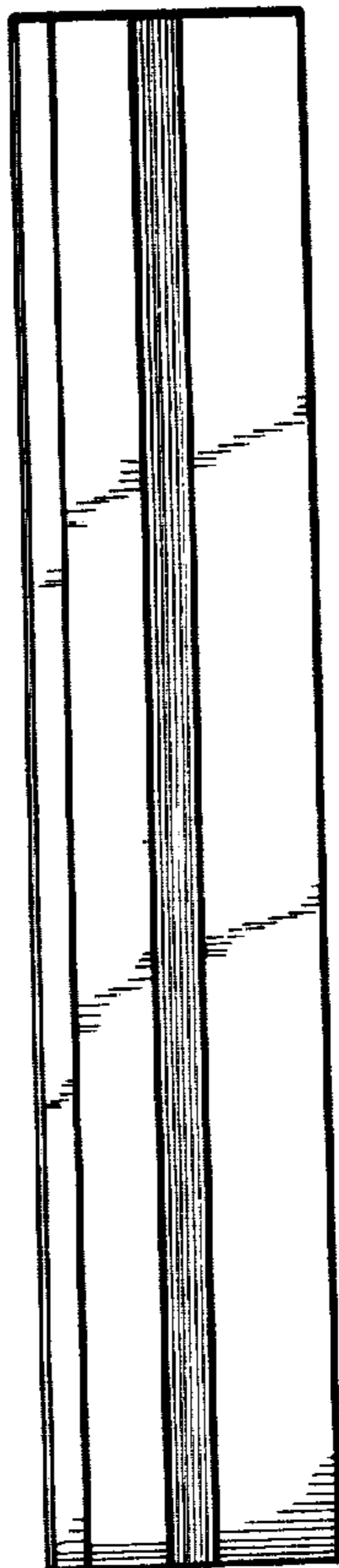

Fig-7

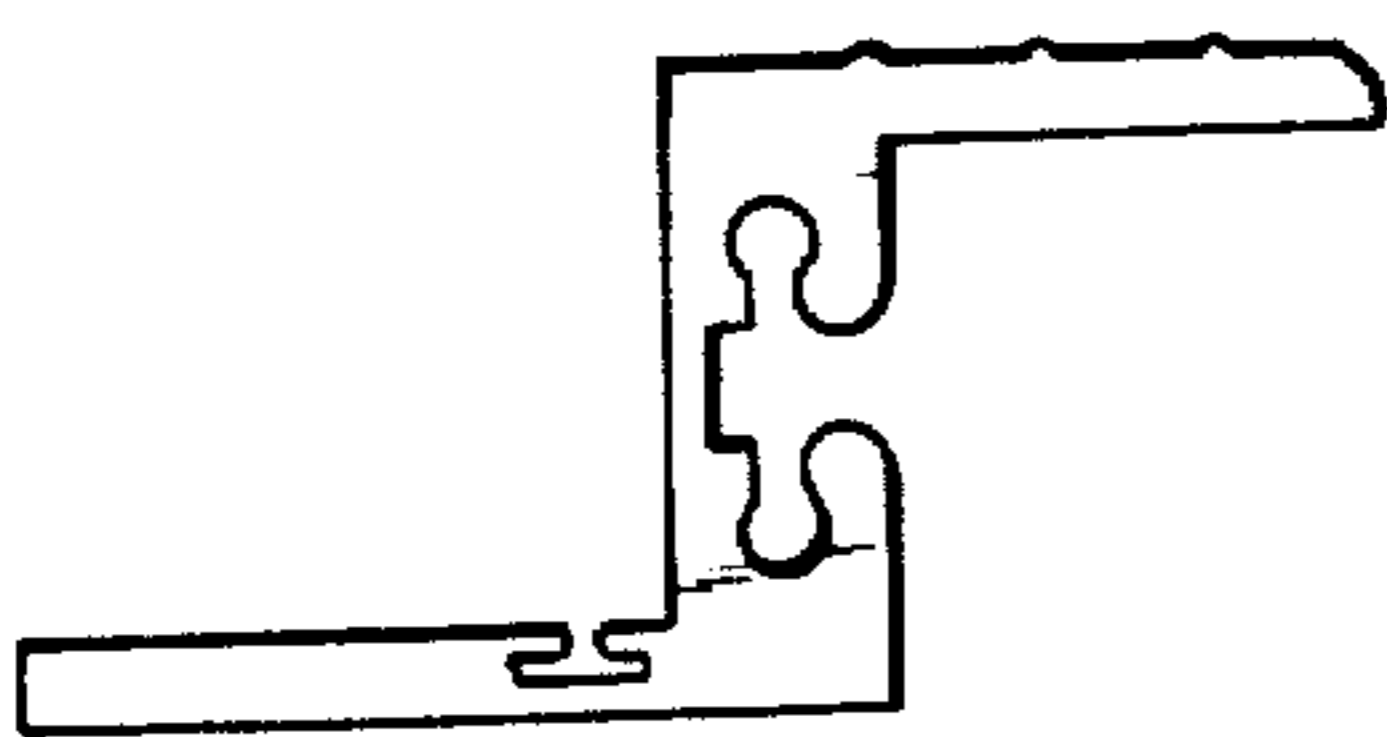
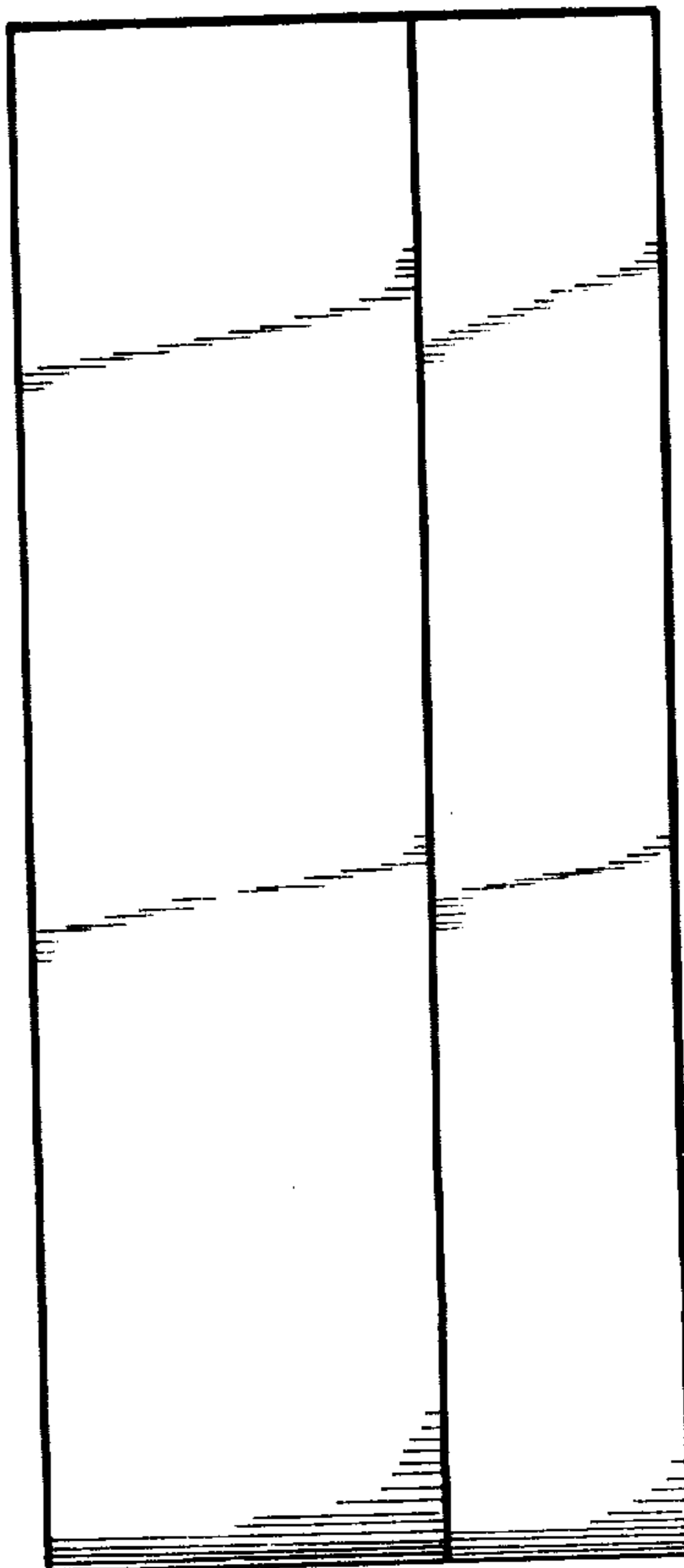

Fig-3