

[54] MIRROR TOY

[76] Inventors: Gene Brunson, 631 White St.; Paul Douglas, 934 Carrie St., both of Walla Walla, Wash. 99362

[**] Term: 14 Years

[21] Appl. No.: 169,130

[22] Filed: Jul. 15, 1980

[51] Int. Cl. D21-01

[52] U.S. Cl. D21/59

[58] Field of Search D21/59, 240, 241, 60; 272/1 R, 8 R, 8 N; 46/1 R; D28/65, 69

[56] References Cited

U.S. PATENT DOCUMENTS

- D. 93,875 11/1934 Hodny et al. D28/65
- D. 110,921 8/1938 Fein D28/65
- 1,989,437 1/1935 Weisz D28/65

OTHER PUBLICATIONS

Childcraft Catalog, 1975, p. 4, "Pat the Bunny" Item, K122.

Primary Examiner—Charles A. Rademaker
Attorney, Agent, or Firm—Fulwider, Patton, Rieber, Lee & Utecht

[57] CLAIM

The ornamental design for a mirror toy, substantially as shown.

DESCRIPTION

FIG. 1 is a perspective view of a mirror toy showing our new design;
 FIG. 2 is a right side elevational view thereof;
 FIG. 3 is a top plan view thereof;
 FIG. 4 is a bottom plan view thereof;
 FIG. 5 is a reduced size rear elevational view thereof; and
 FIG. 6 is a reduced size perspective view, taken generally from the rear, and showing a portion of the mirror toy illustrated in FIGS. 1 through 5 separated from the rest of the mirror toy.

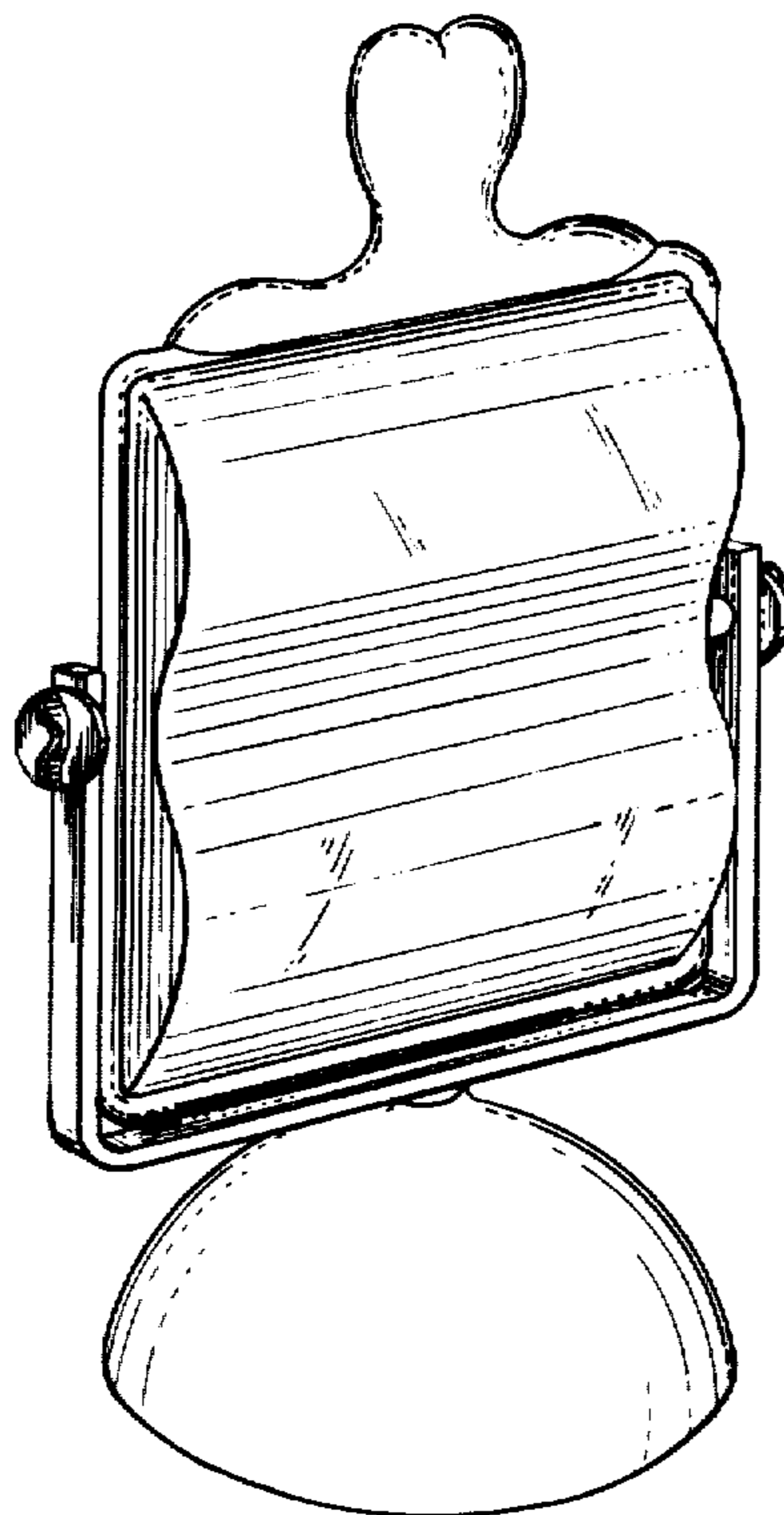

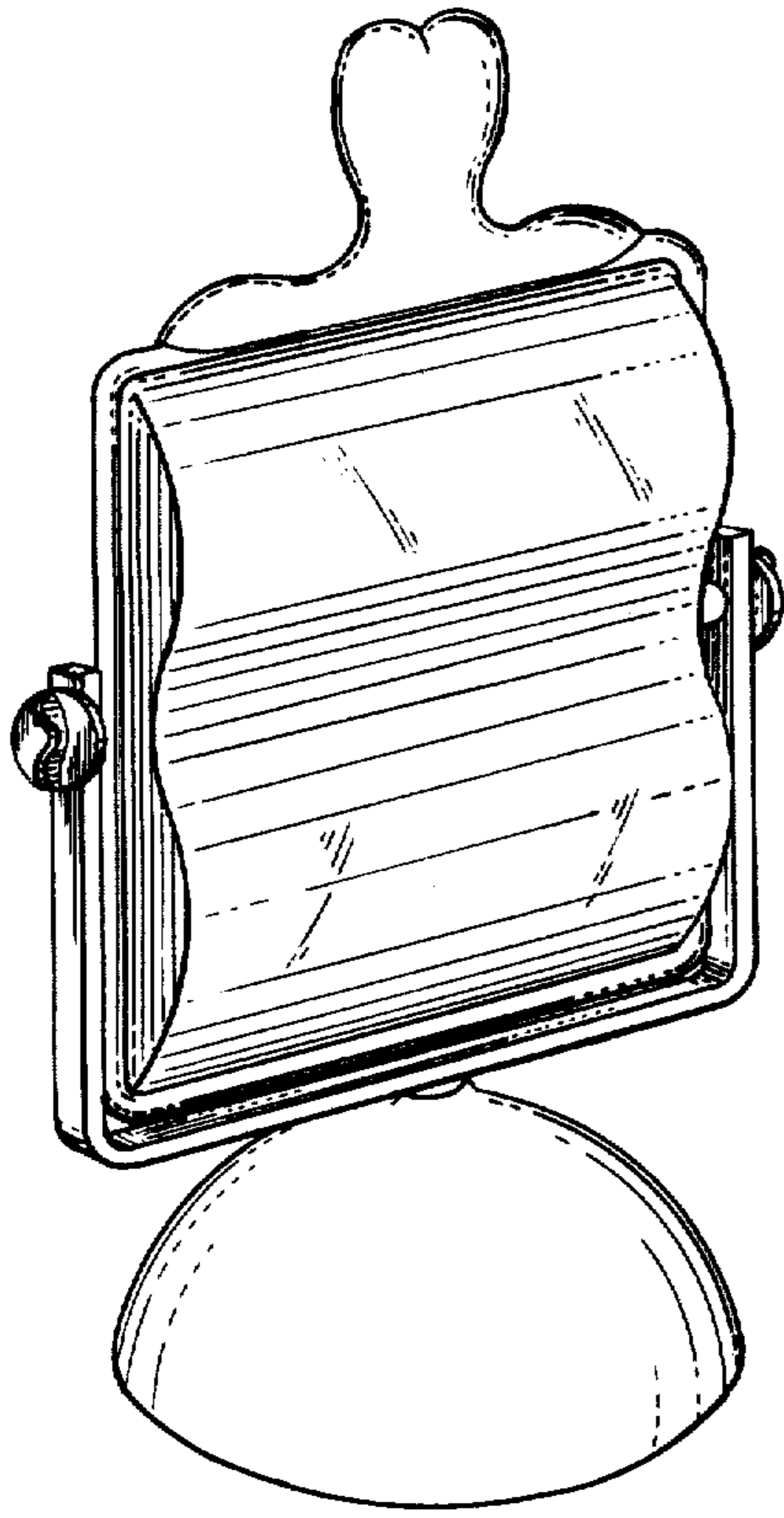

Fig. 1

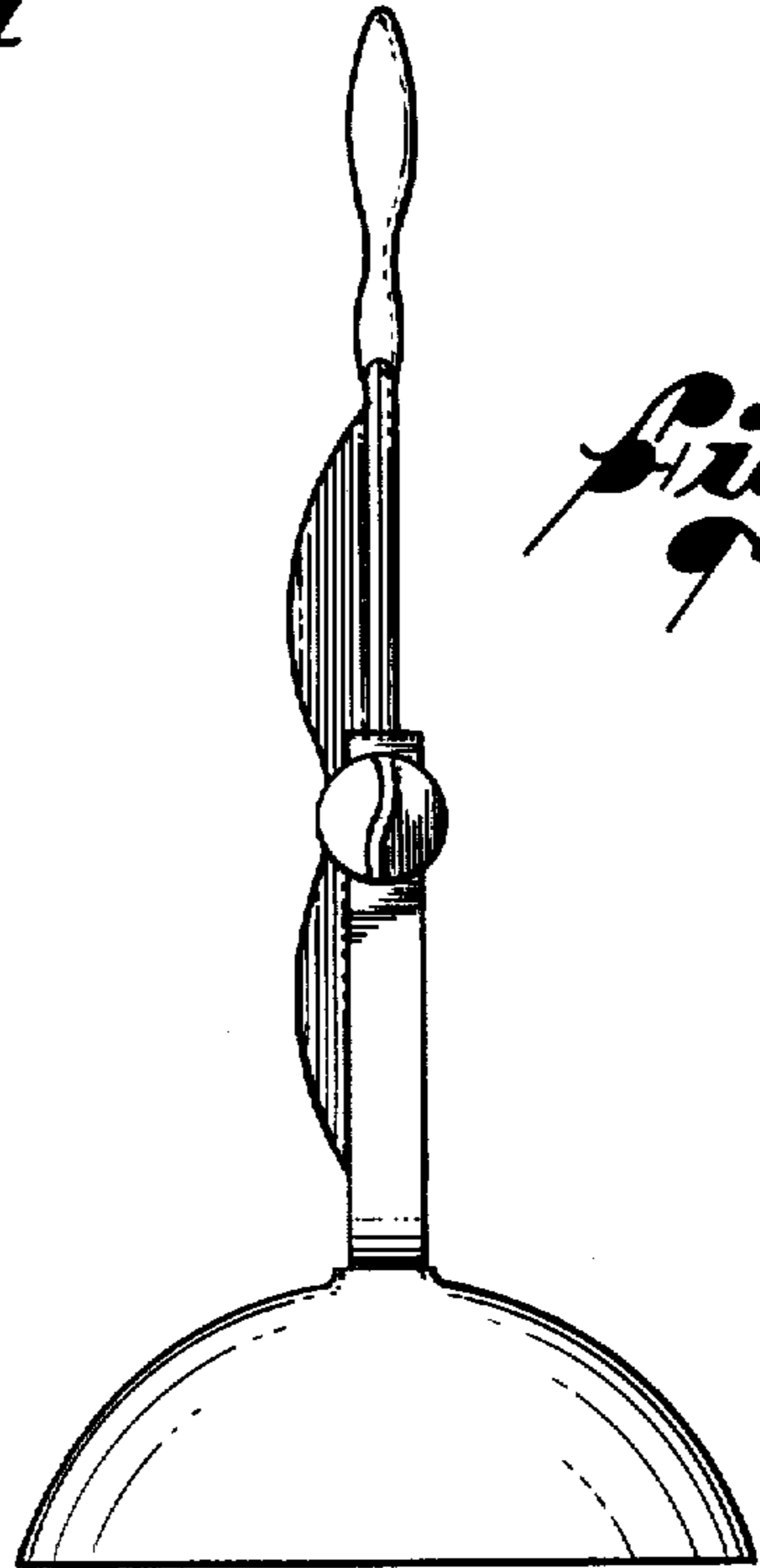

Fig. 2

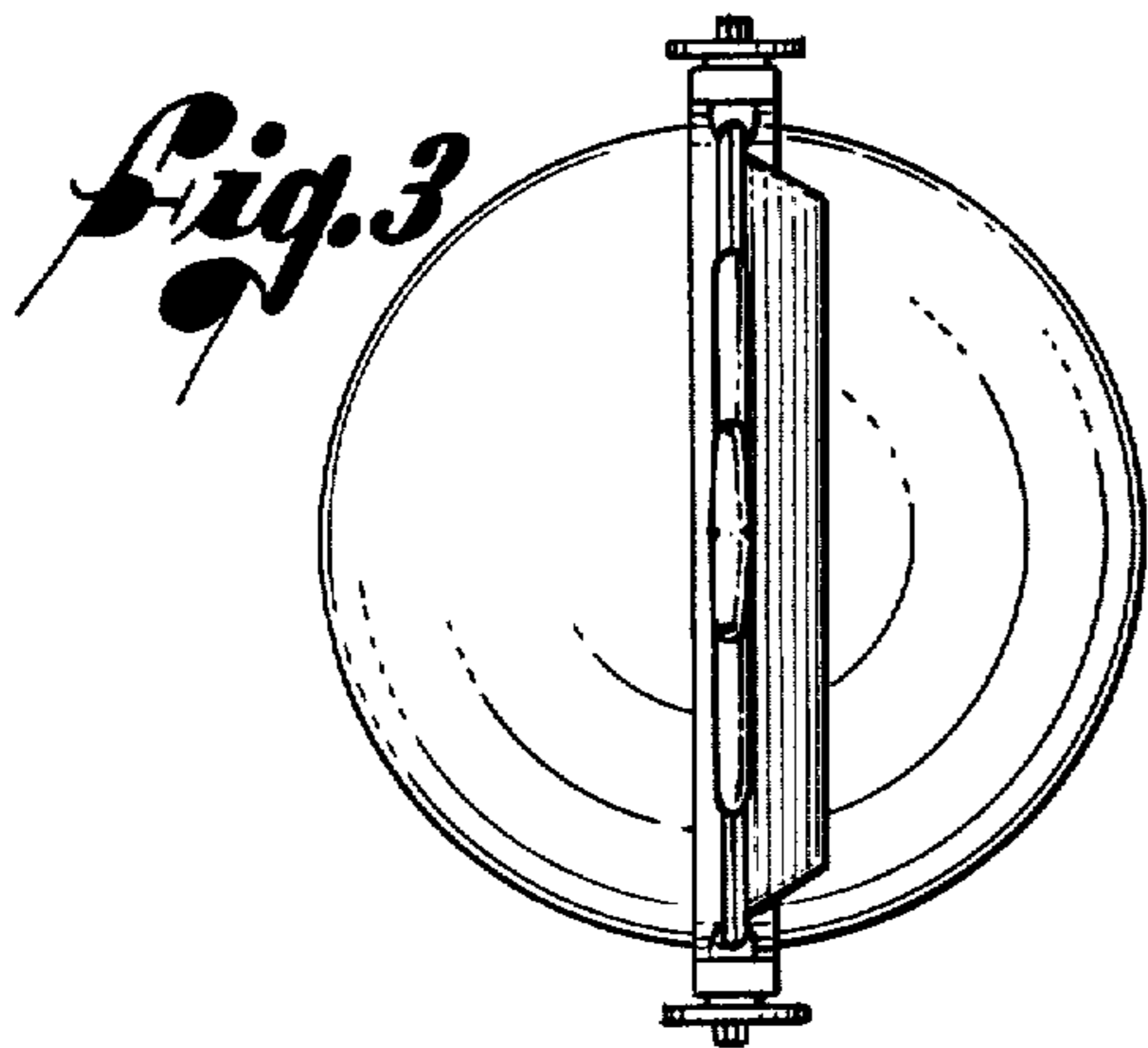

Fig. 3

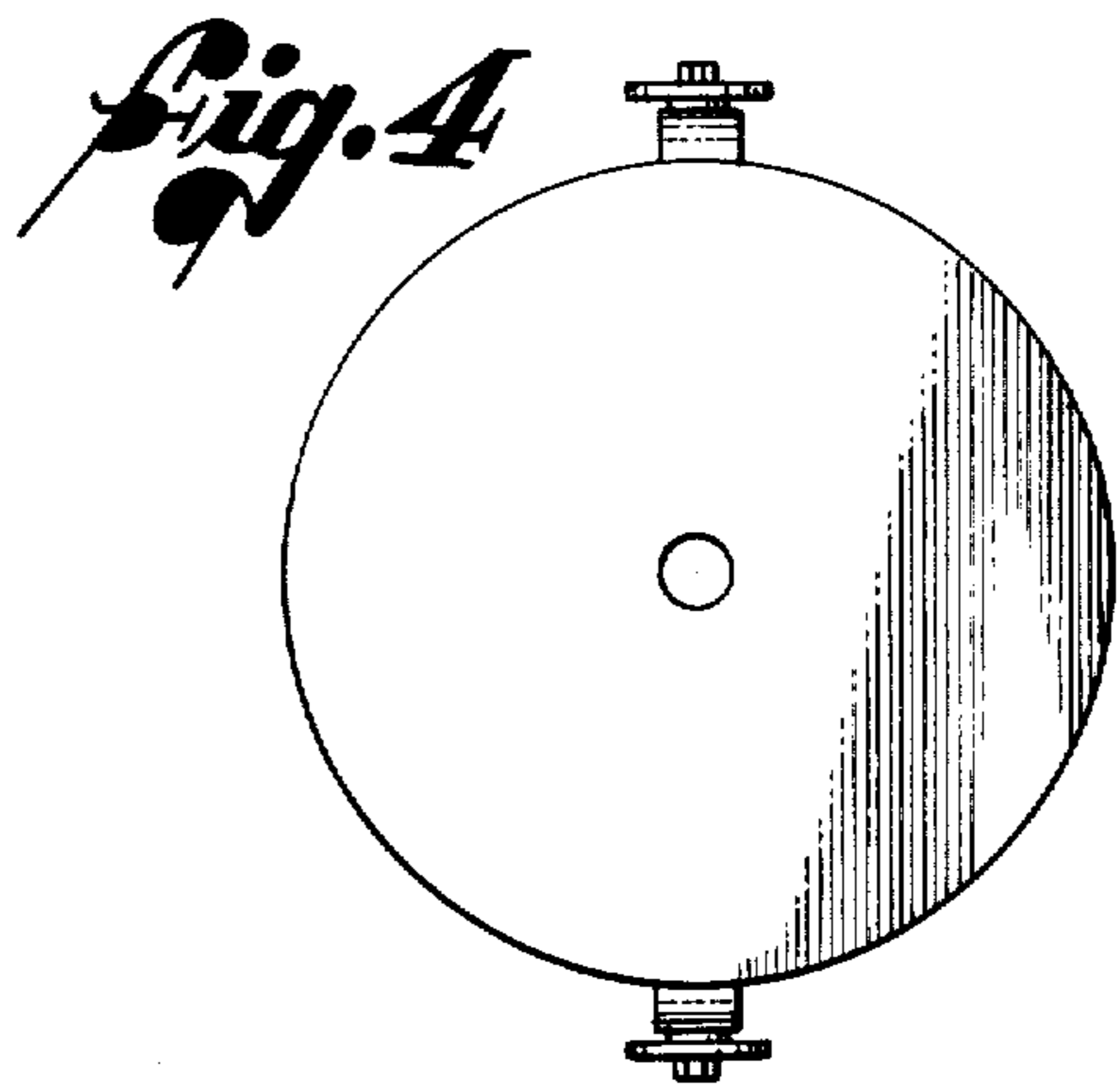

Fig. 4

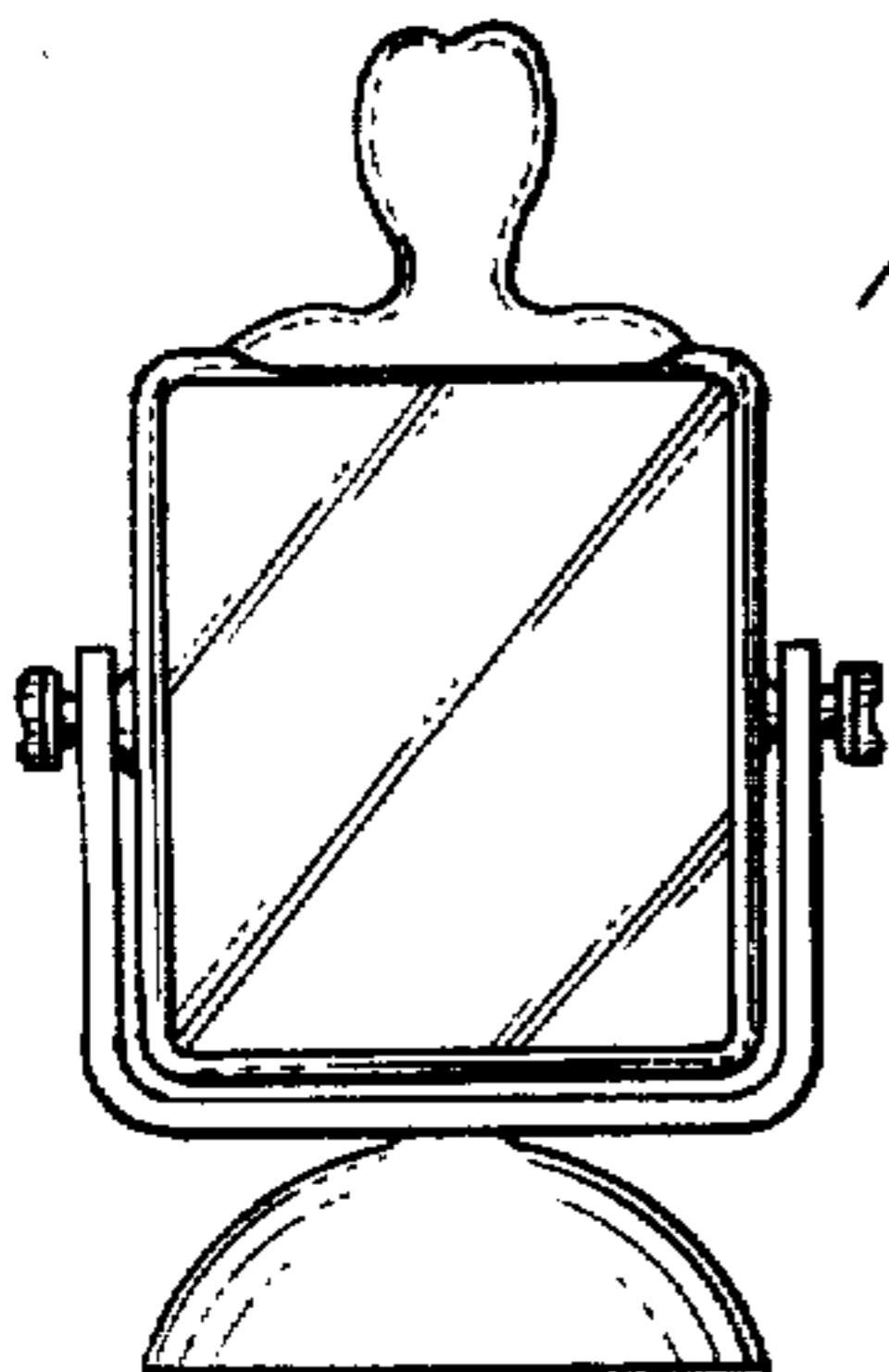

Fig. 5

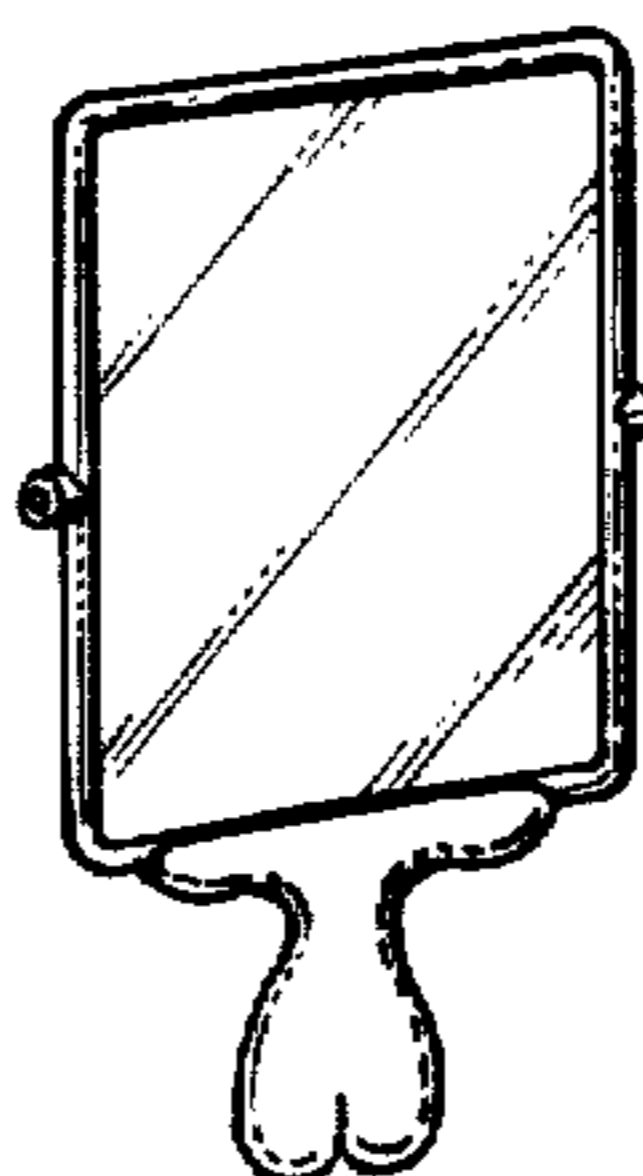

Fig. 6