

[54] SOAP HOLDER

[75] Inventor: Bruce R. Thompson, Tranmere, Australia

[73] Assignee: UPL Group Limited, Brisbane, Australia

[**] Term: 14 Years

[21] Appl. No.: 121,233

[22] Filed: Feb. 13, 1980

[51] Int. Cl. D23-02

[52] U.S. Cl. D6/90

[58] Field of Search D6/86-104, D6/132, 133; 206/77.1; 211/13, 87, 88; 108/152

[56] References Cited

U.S. PATENT DOCUMENTS

- D. 144,326 4/1946 Van Doren D6/90
- D. 238,729 2/1976 Vrignaud D6/90
- D. 241,199 8/1976 Halsted et al. D6/90

OTHER PUBLICATIONS

Sweet's Architectural Catalog File 1969, Sec. 25d/La; p. 32, Soap Dish 805; Sec. 25d/Rel, p. 6, Soap Dish 365.

Primary Examiner—B. J. Bullock

Attorney, Agent, or Firm—McDougall, Hersh & Scott

[57] CLAIM

The ornamental design for a soap holder, as shown.

DESCRIPTION

FIG. 1 is a perspective view of a soap holder showing my new design;

FIG. 2 is a top view thereof;

FIG. 3 is a bottom view thereof;

FIG. 4 is a front view thereof;

FIG. 5 is a rear view thereof;

FIG. 6 is a sectional view taken in the direction of the arrows on line VI—VI of FIG. 2;

FIG. 7 is a side view taken from the left of FIG. 1, the side opposite being a mirror image thereof; and

FIG. 8 is a sectional view taken in the direction of the arrows on line VIII—VIII of FIG. 2.

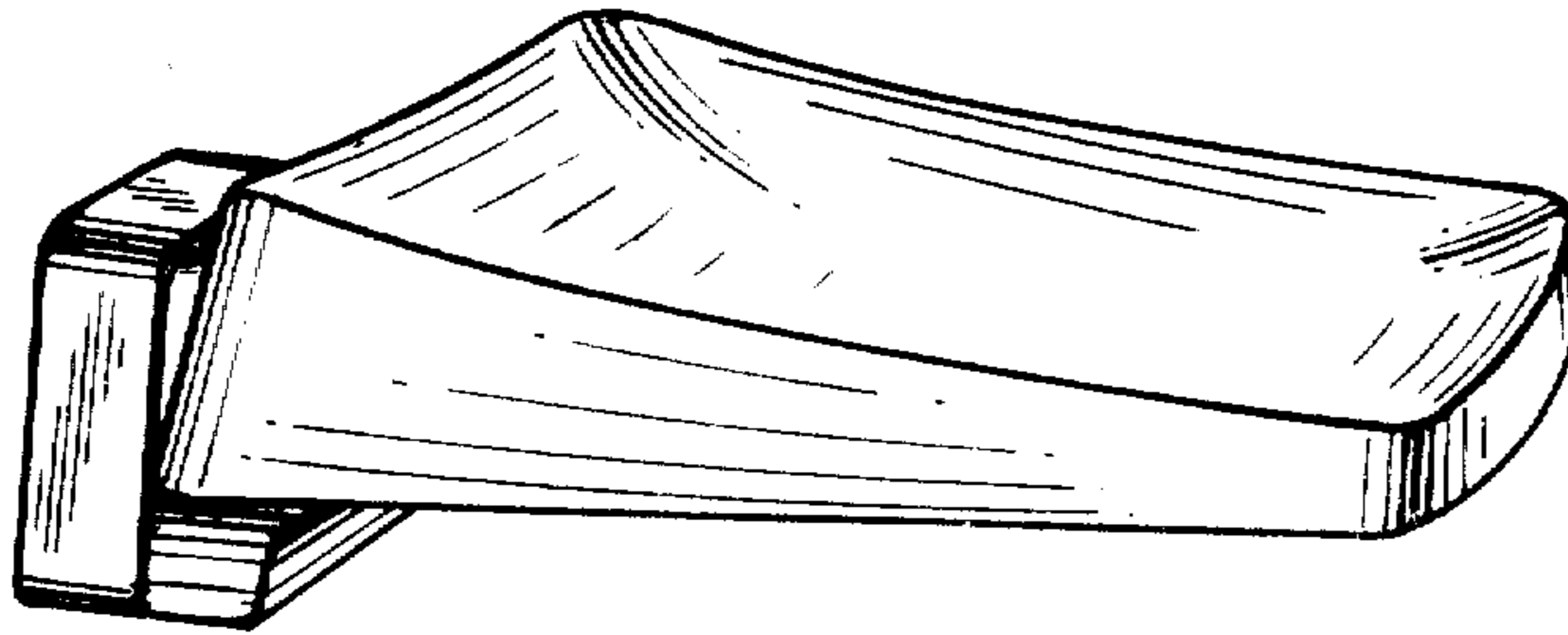

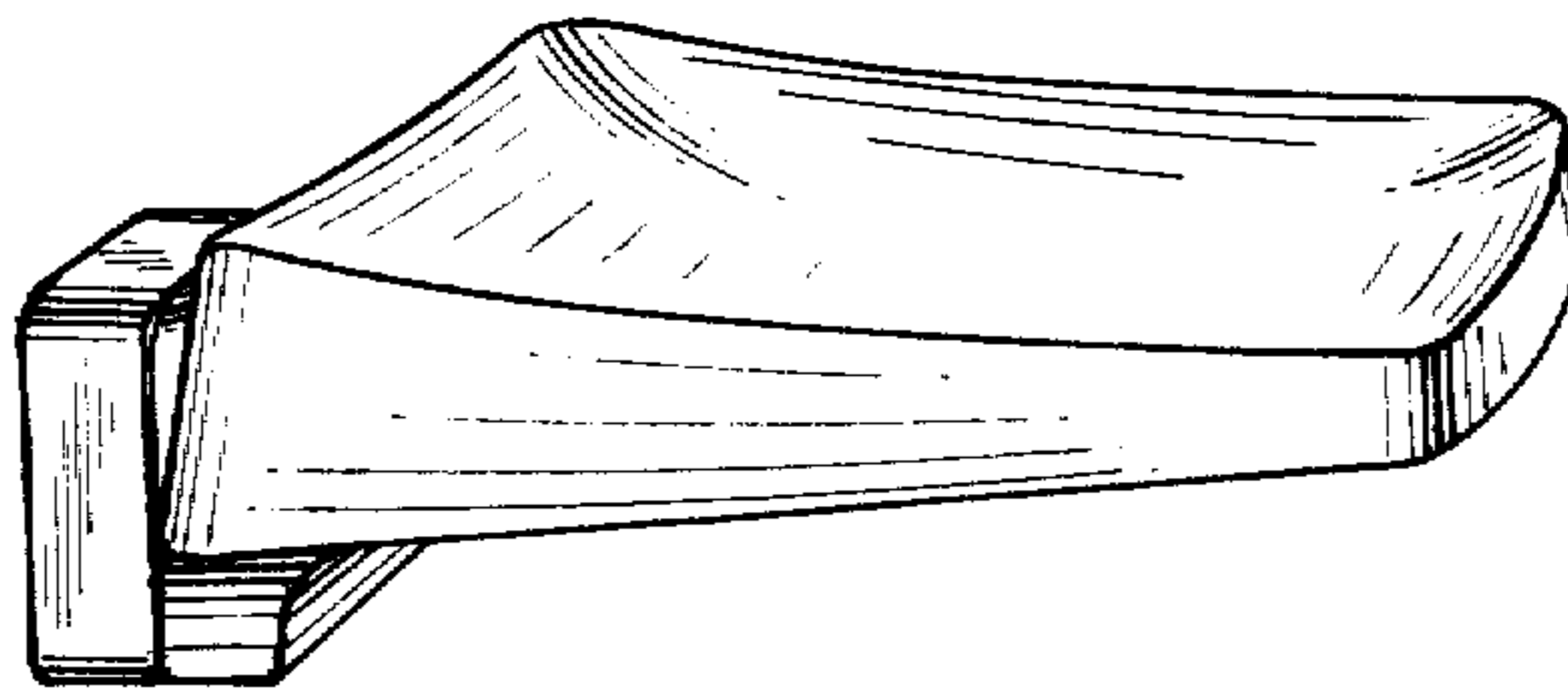

FIG. 1

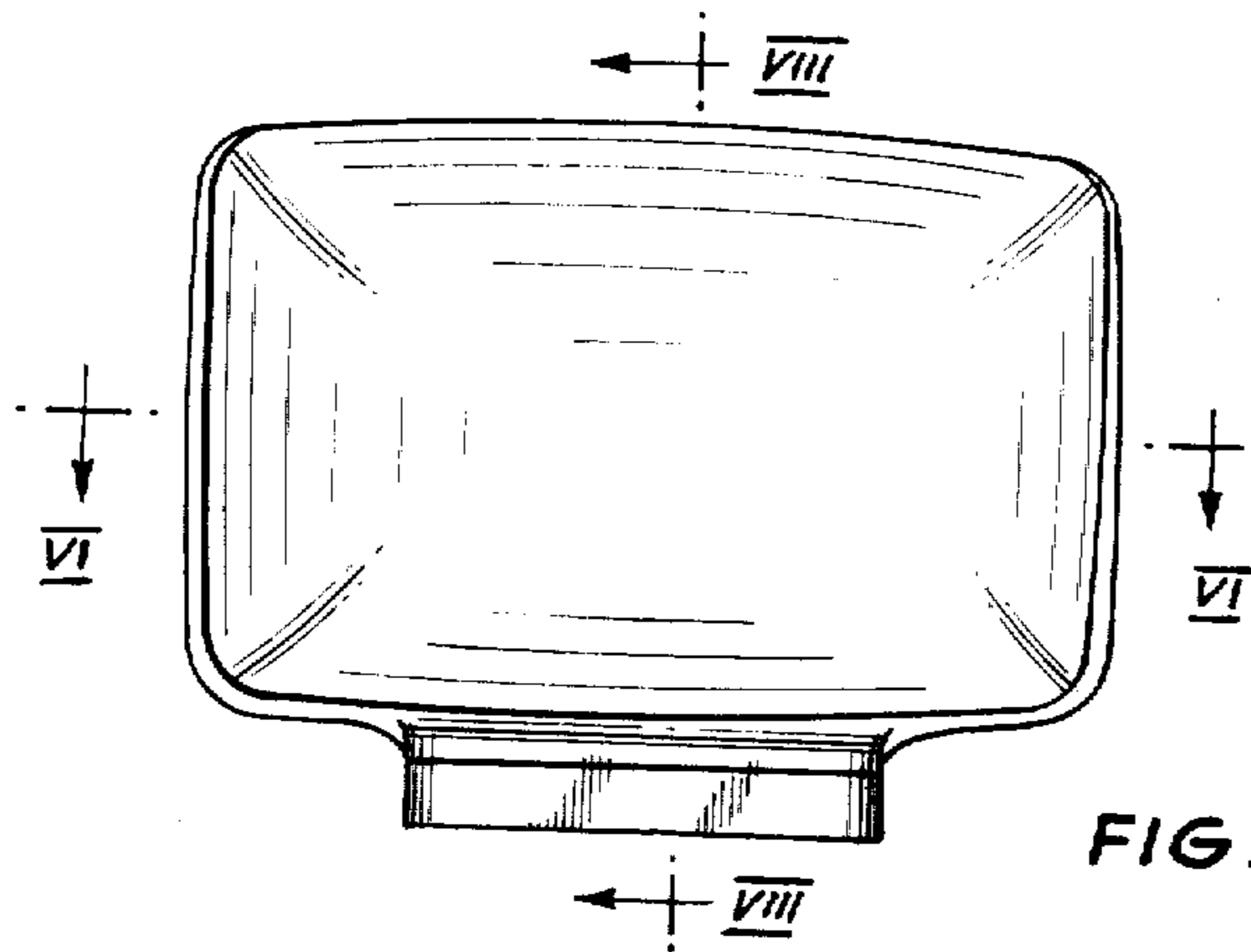

FIG. 2

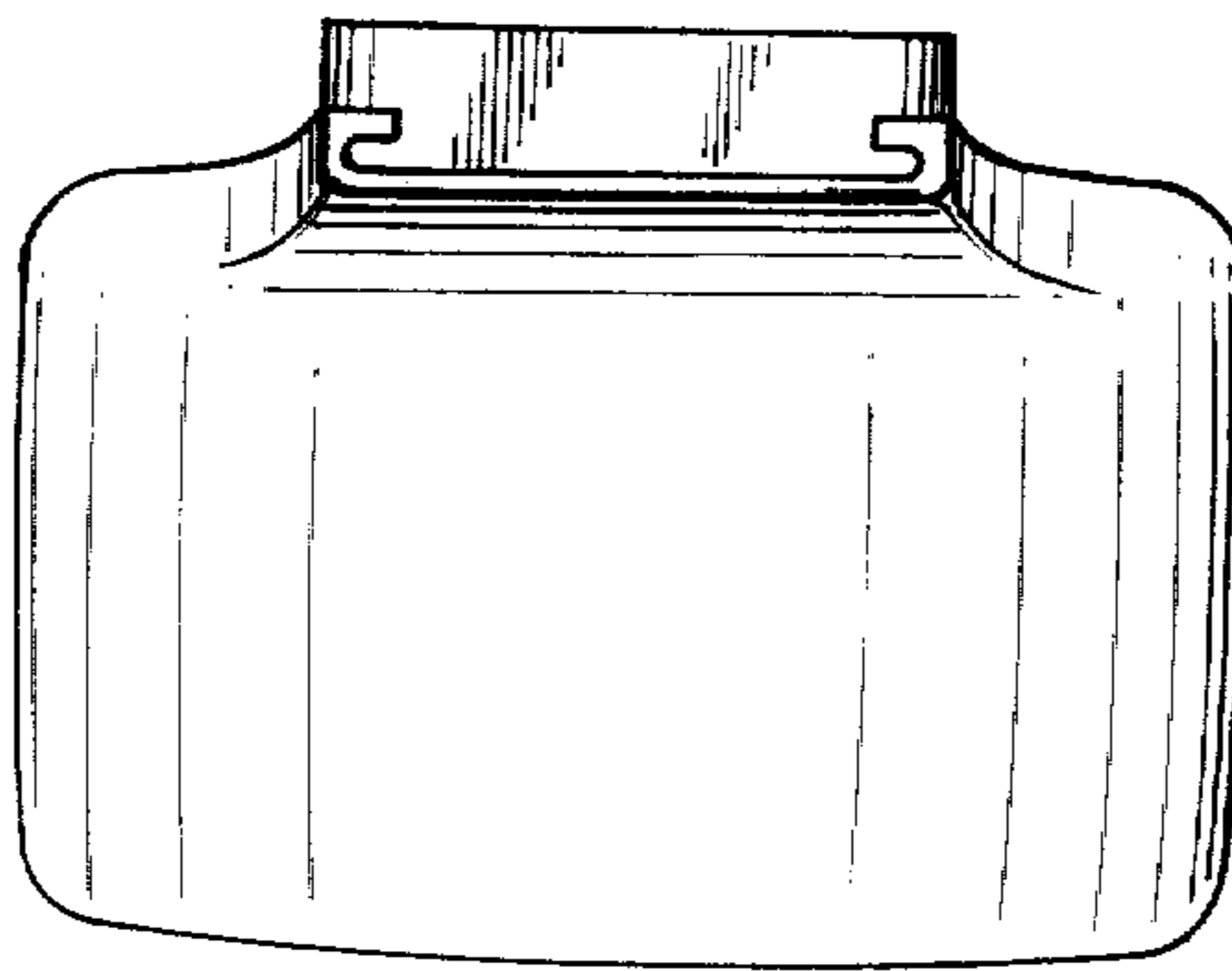

FIG. 3

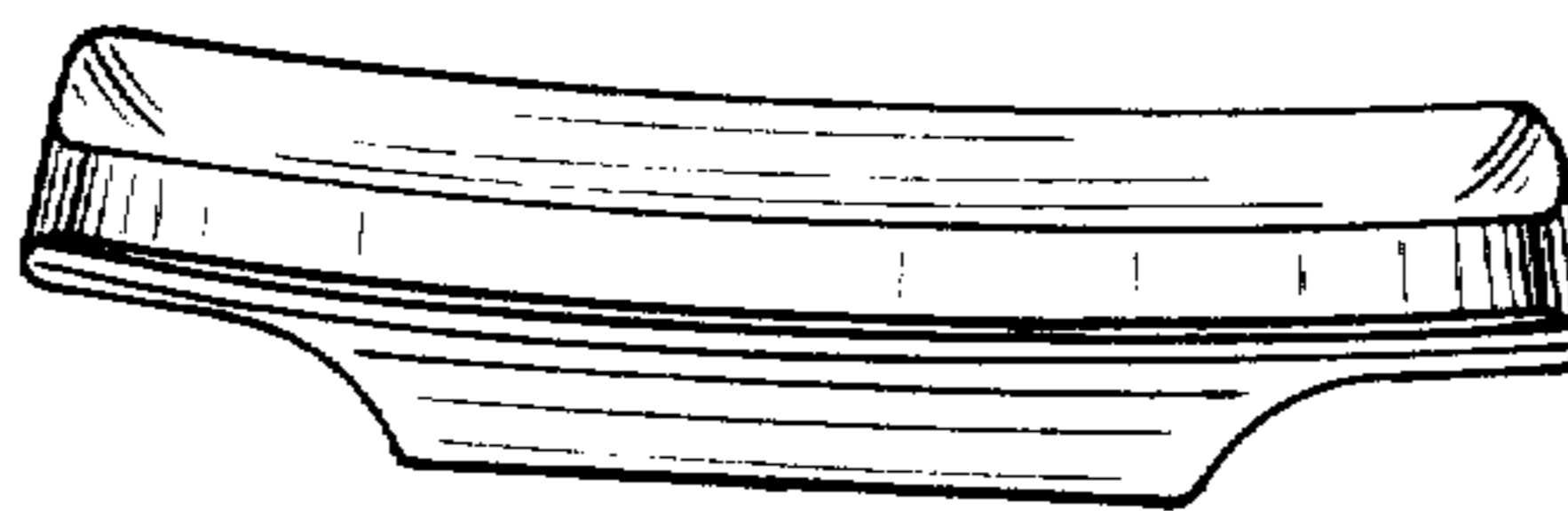

FIG. 4

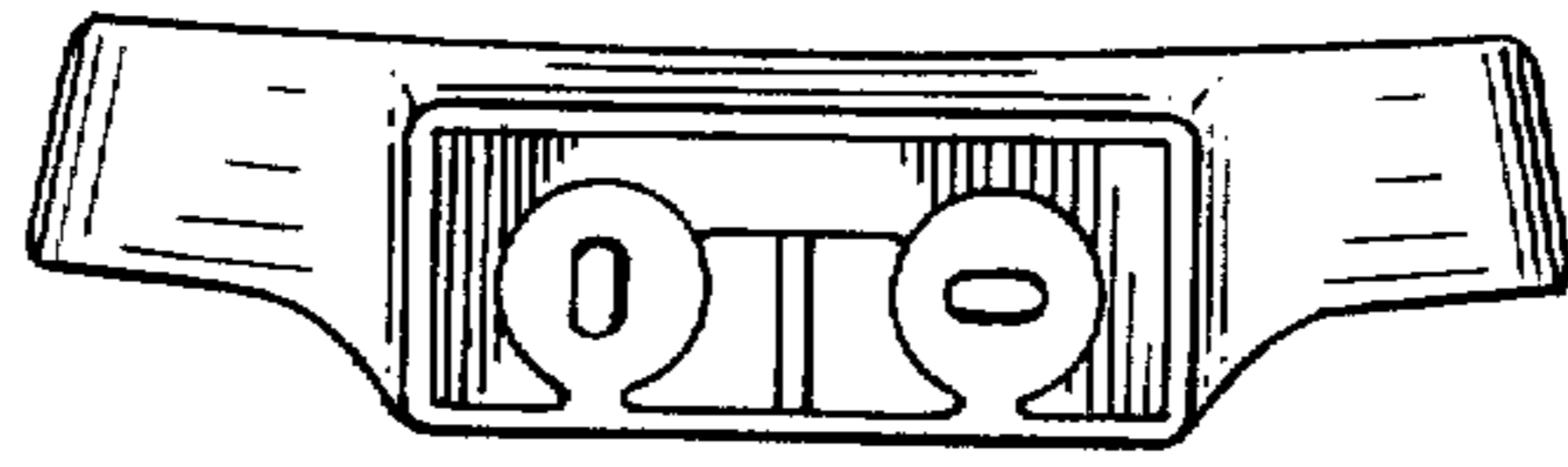

FIG. 5

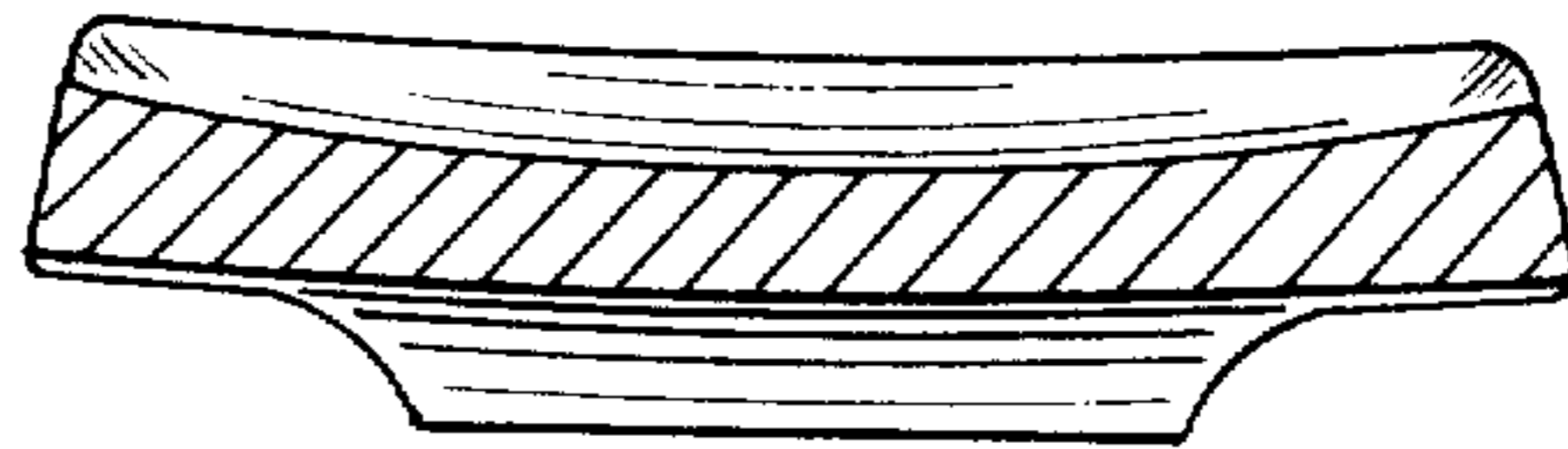

FIG. 6

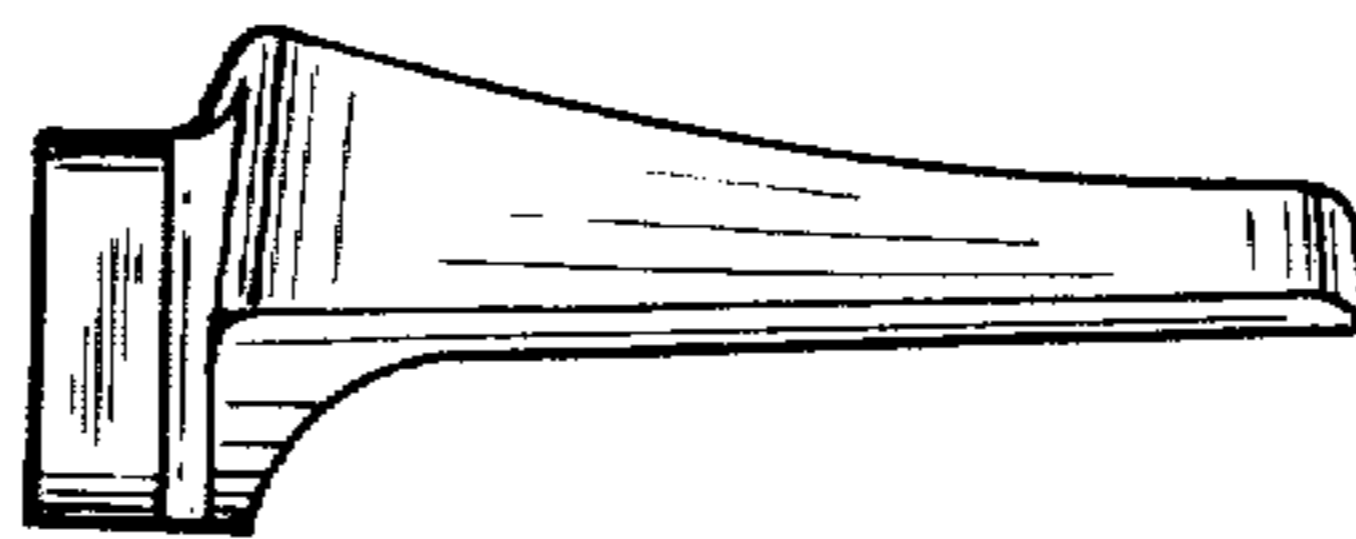

FIG. 7

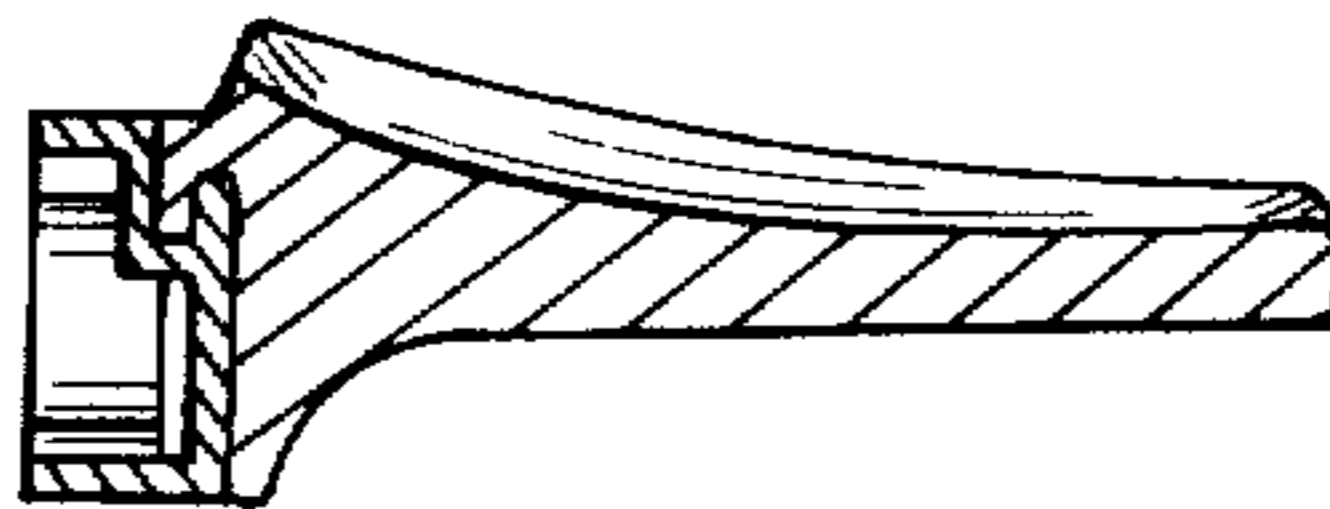

FIG. 8