

[54] **STACKABLE WATERING CONTAINER**

[75] Inventor: **Monte L. Levin, New York, N.Y.**

[73] Assignee: **Misco Enterprises Inc., New York, N.Y.**

[**] Term: **14 Years**

[21] Appl. No.: **213,574**

[22] Filed: **Dec. 5, 1980**

[51] Int. Cl. **D23-01**

[52] U.S. Cl. **D23/11; D7/64**

[58] Field of Search **D23/11; D7/59, 60, 64, D7/65, 66, 67; 206/519, 520; 239/377, 436; 222/572, 573**

[56] **References Cited**

U.S. PATENT DOCUMENTS

D. 172,675	7/1954	Mandell	D23/11
D. 184,893	4/1959	Reinecke	D23/11
D. 192,519	4/1962	Roop	D23/11
D. 209,341	11/1967	Gale	D23/11
D. 241,032	8/1976	Burke	D23/11
D. 241,248	8/1976	Burke	D23/11
D. 251,129	2/1979	Behling	D23/11
880,522	3/1908	Gray	239/377 X

3,841,528 10/1974 Eisenberg 206/519 X
 4,030,664 6/1977 Tisbo et al. D23/11 X

Primary Examiner—James R. Largen
Attorney, Agent, or Firm—Bauer & Amer

[57] **CLAIM**

The ornamental design for stackable watering container, substantially as shown and described.

DESCRIPTION

FIG. 1 is a top view of stackable watering containers showing my new design;
 FIG. 2 is a side view thereof;
 FIG. 3 is a bottom view thereof;
 FIG. 4 is a cross sectional view taken on line 4—4 of FIG. 2;
 FIG. 5 is a fragmentary cross sectional view taken on line 5—5 of FIG. 2;
 FIG. 6 is a cross sectional view taken on line 6—6 of FIG. 2;
 FIG. 7 is a fragmentary cross sectional view taken on line 7—7 of FIG. 1;
 FIG. 8 is a front view thereof;
 FIG. 9 is a rear view thereof; and
 FIG. 10 is a perspective view taken from the top and the side opposite that shown in FIG. 2.

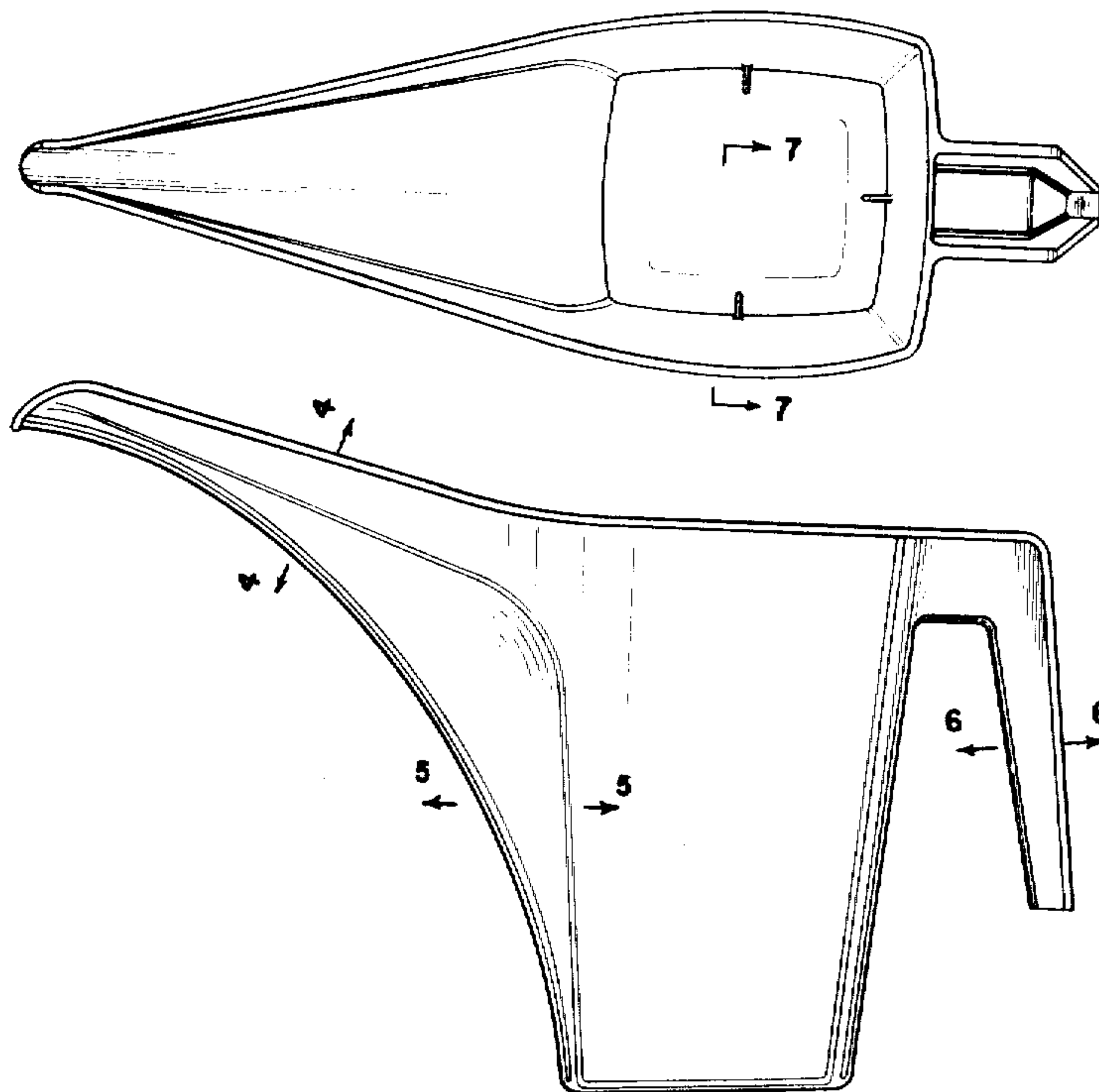

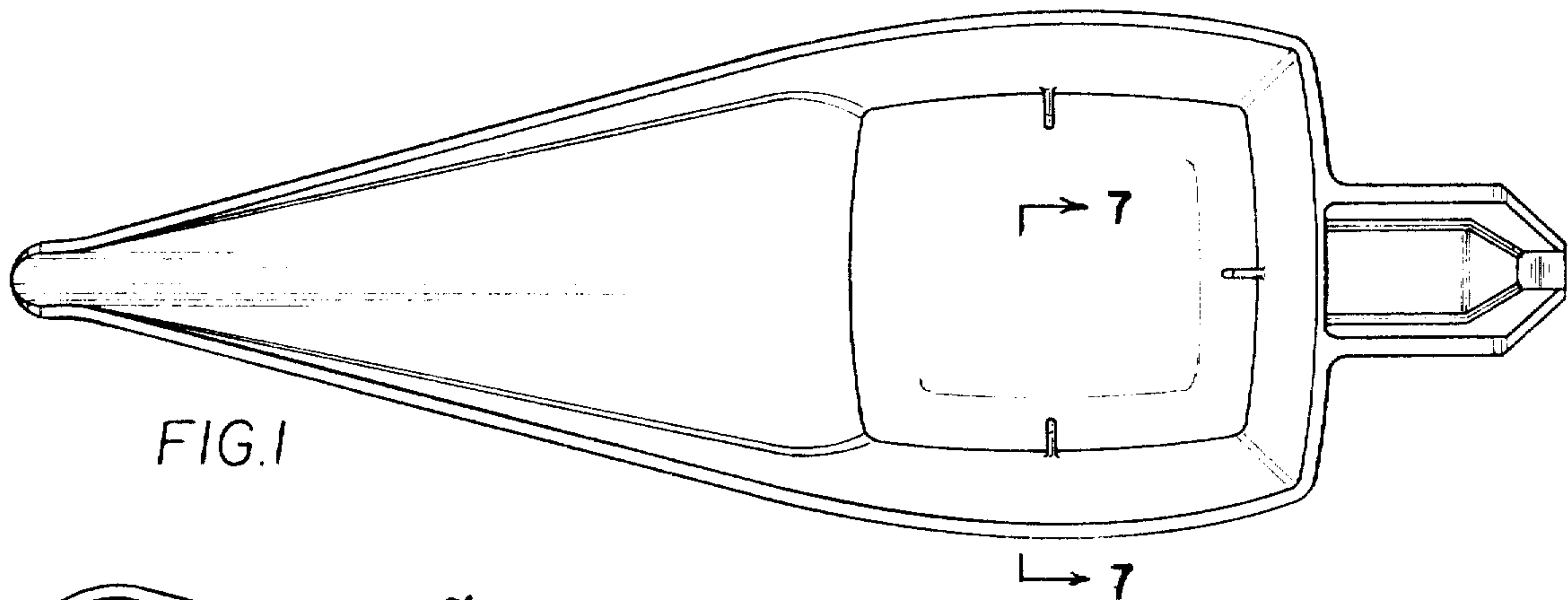

FIG. 1

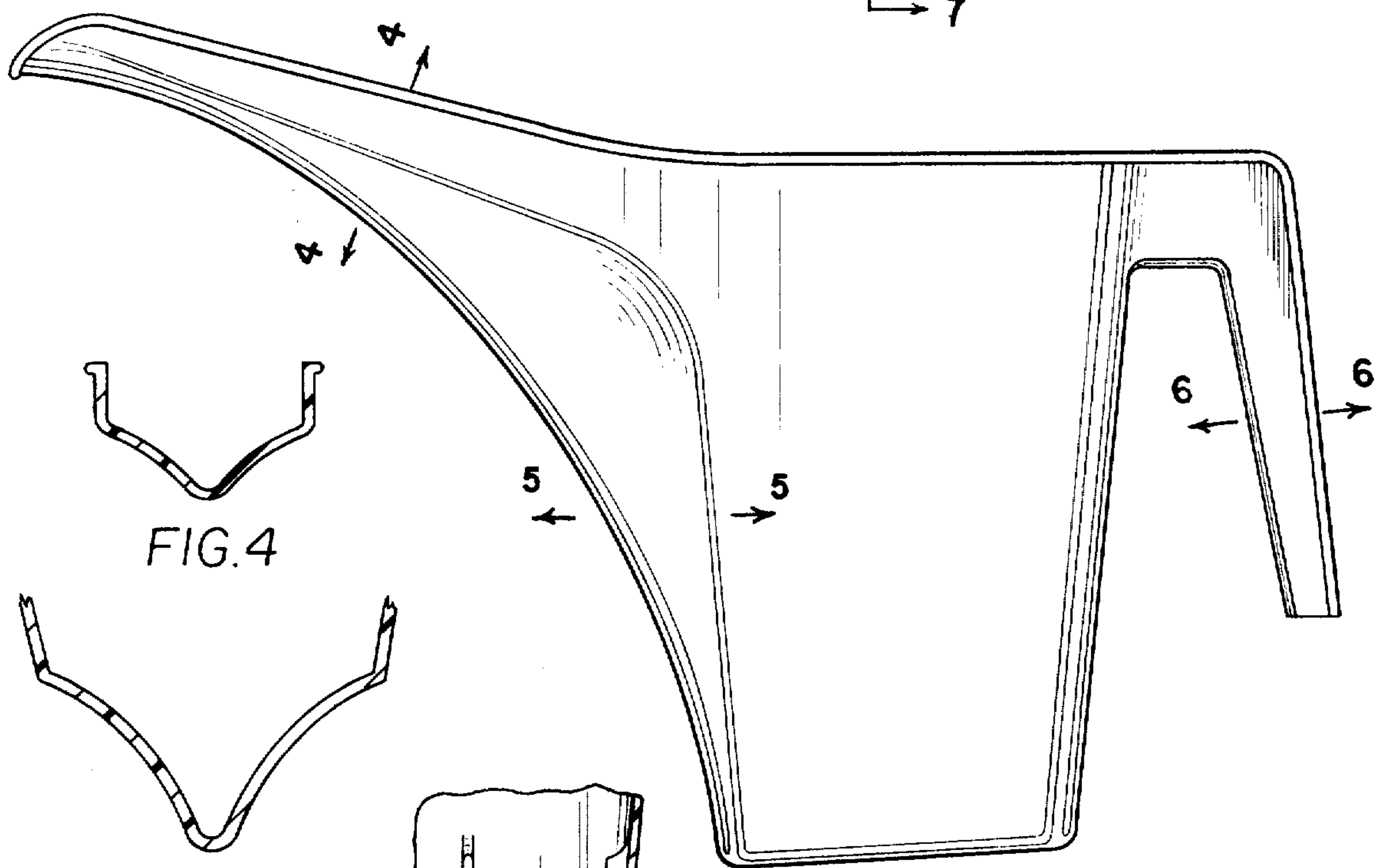

FIG. 4

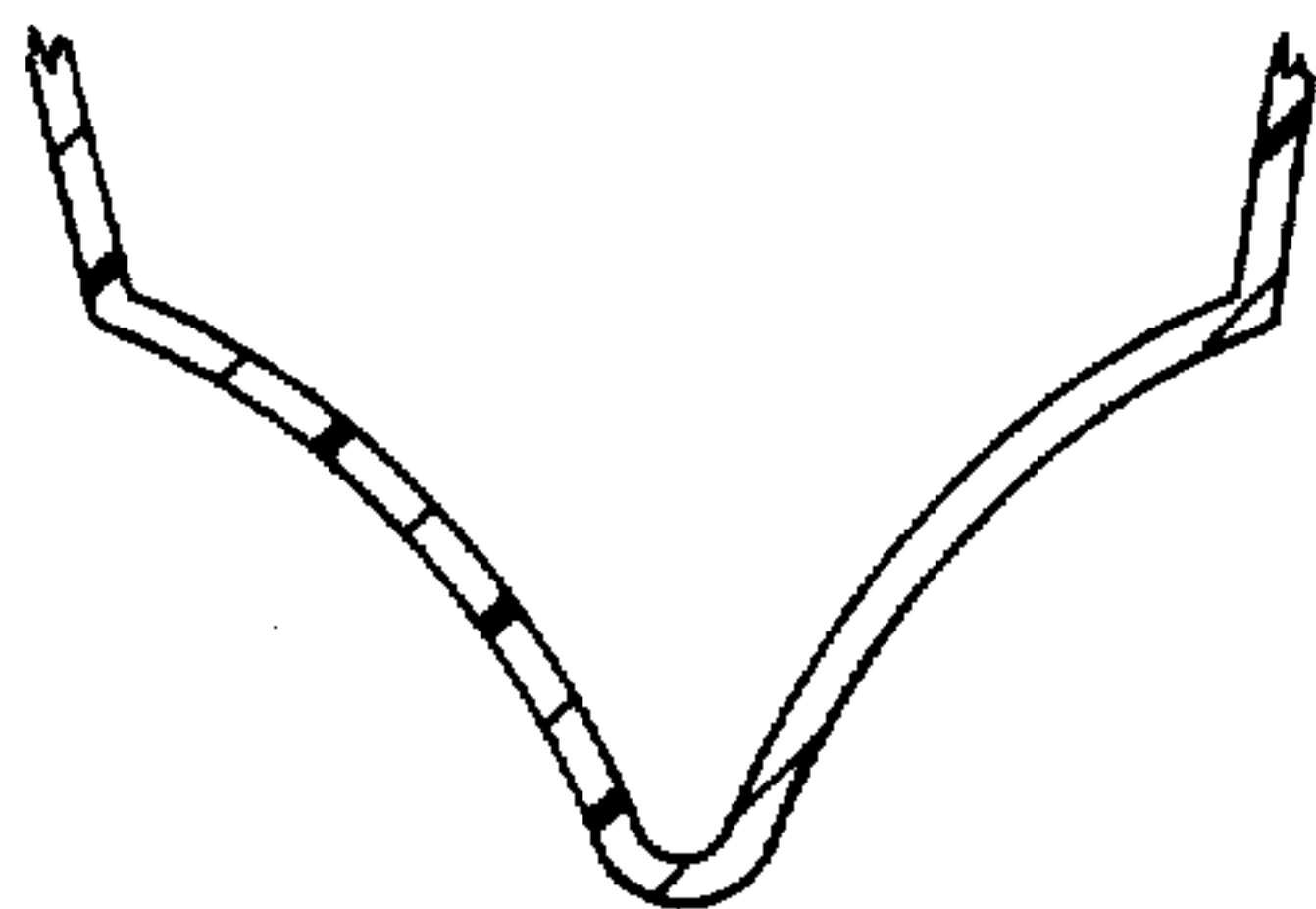

FIG. 5



FIG. 6

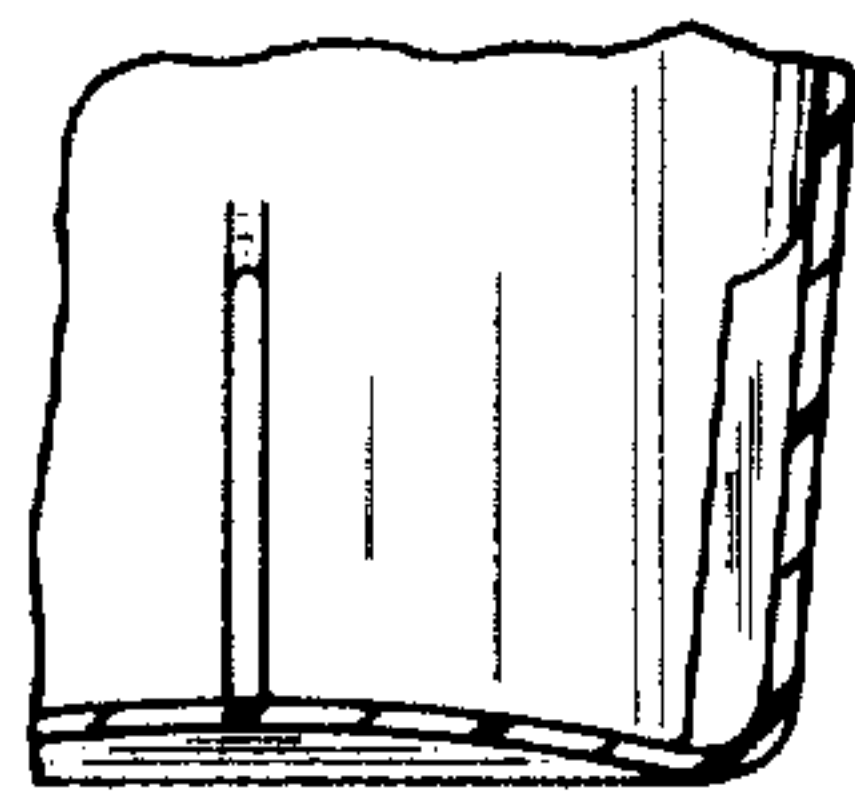

FIG. 7

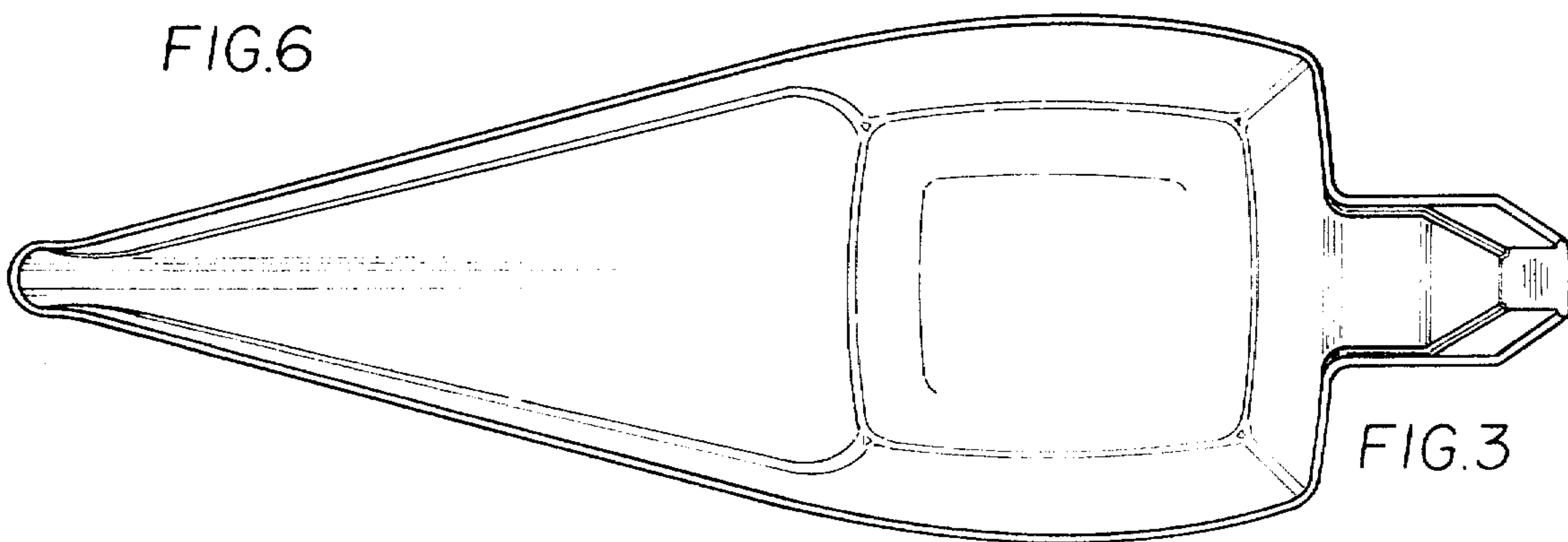

FIG. 3

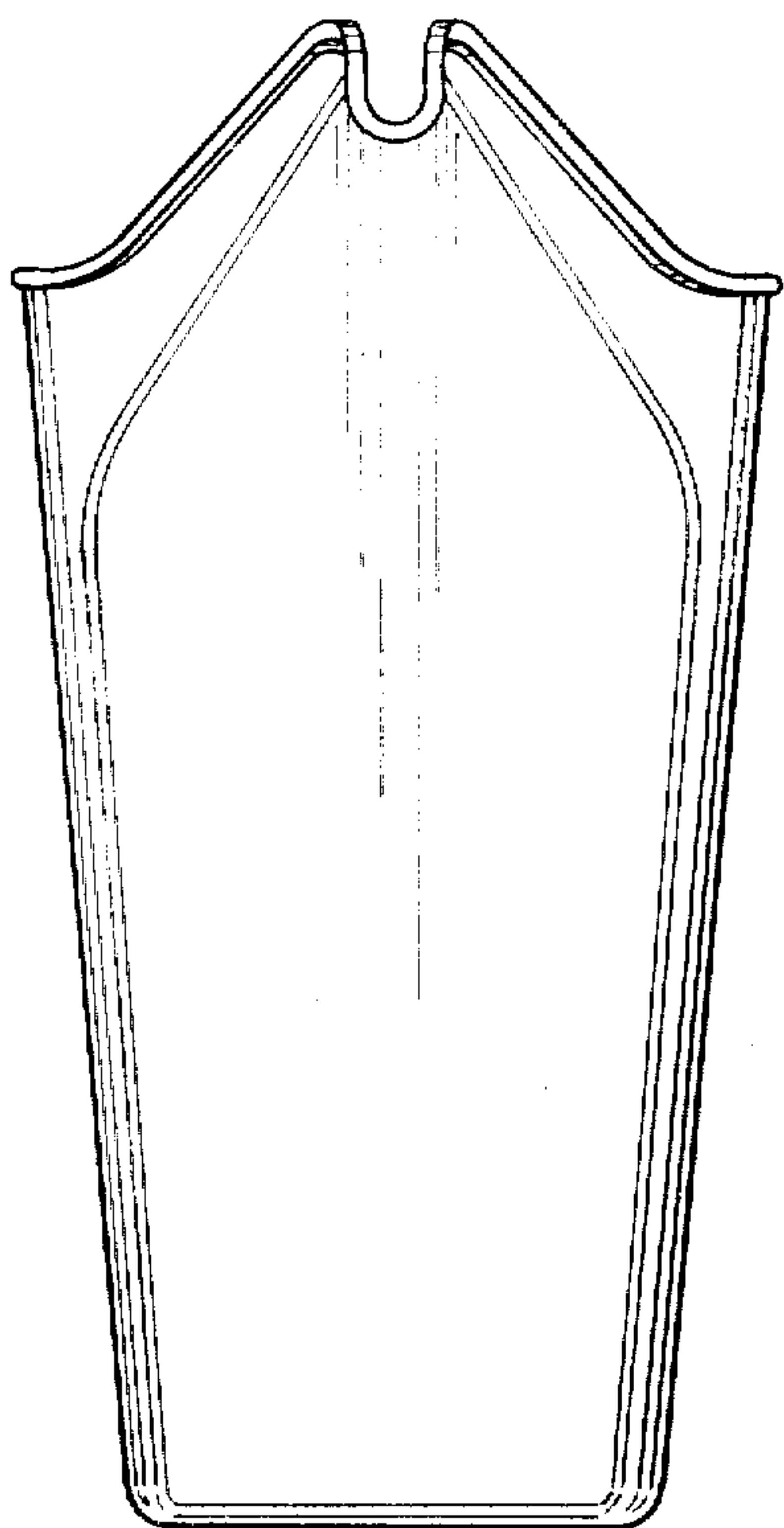

FIG. 8

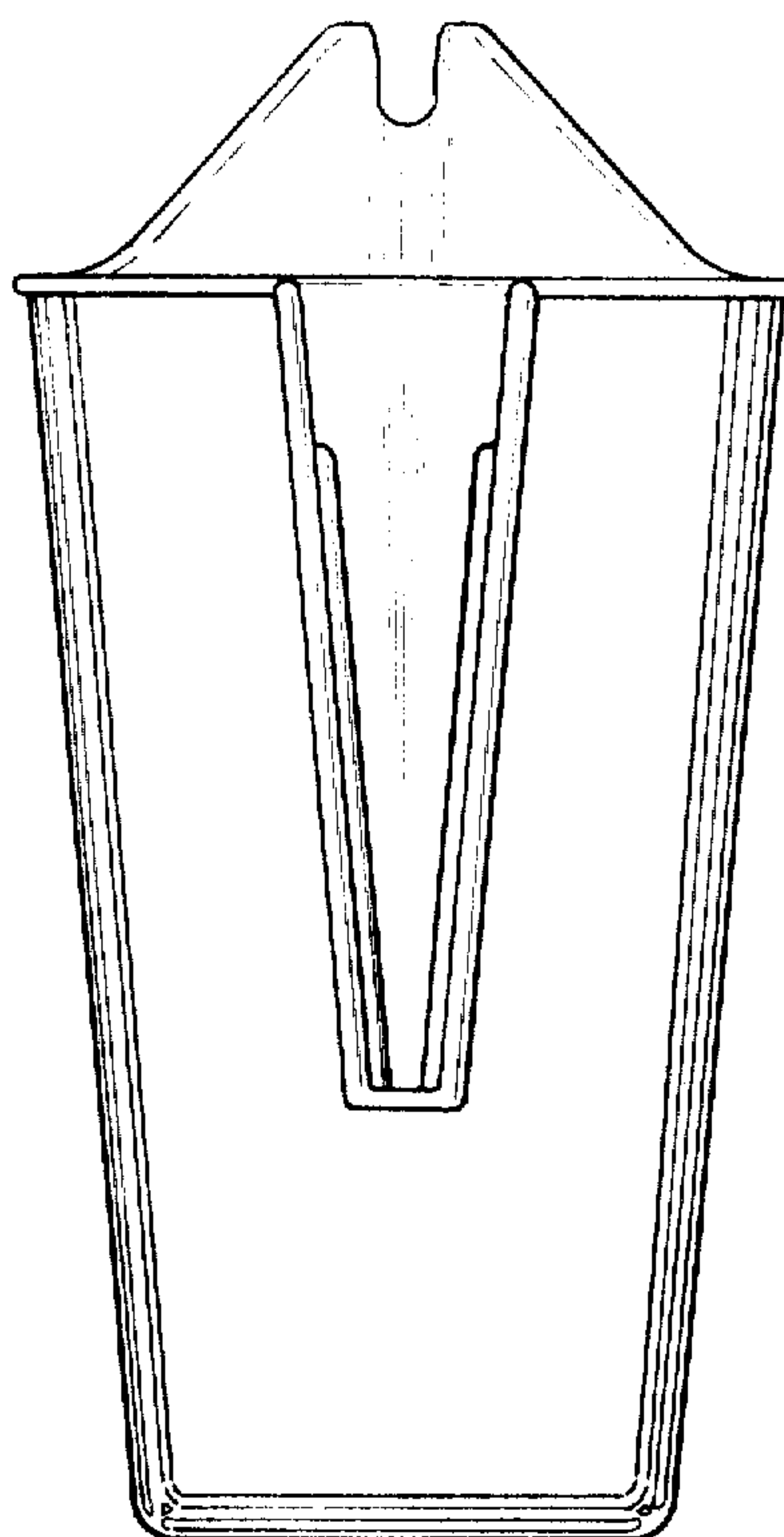

FIG. 9

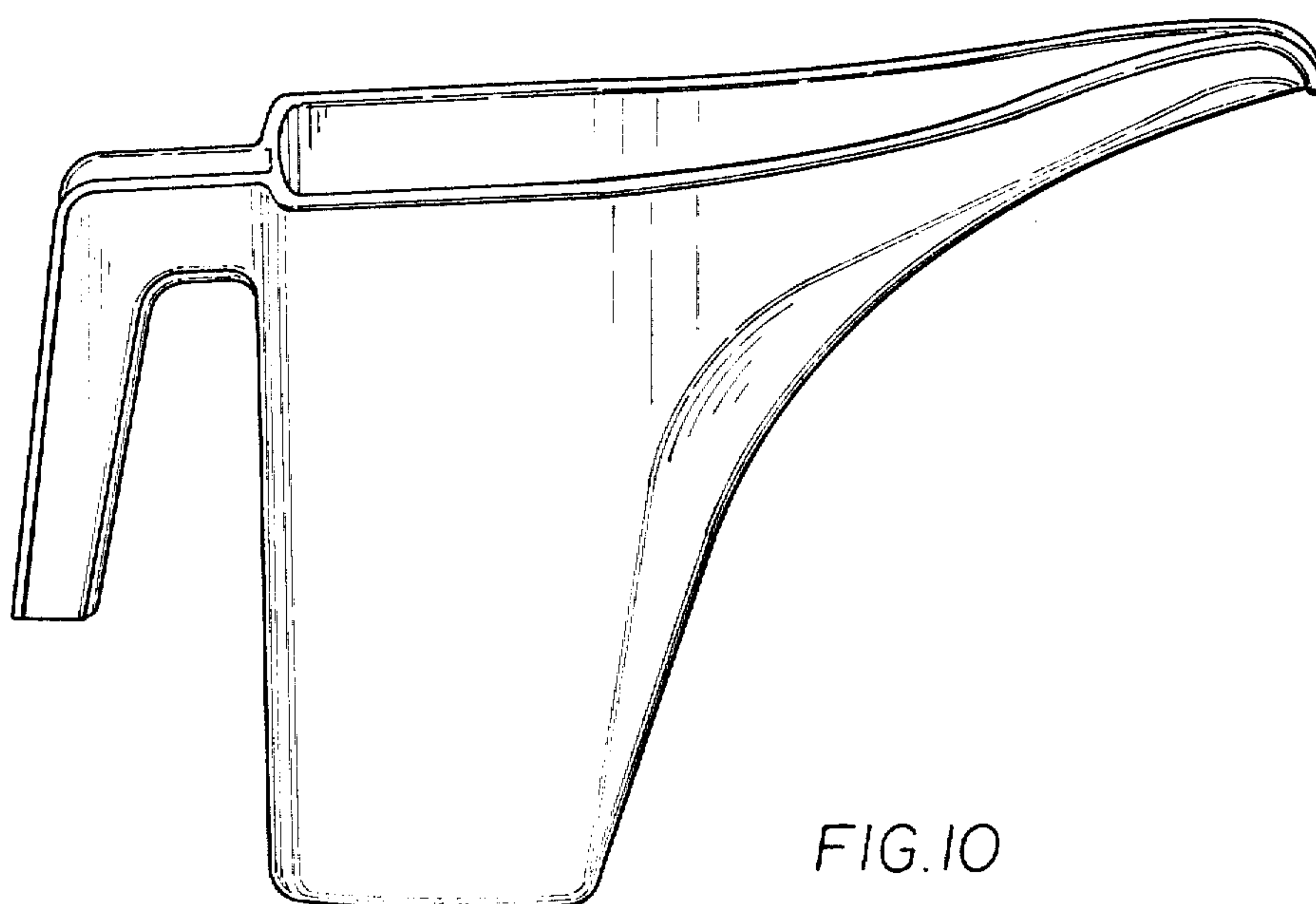

FIG. 10