

[54] STOVE FOR BURNING COMBUSTIBLE SOLID FUELS

[76] Inventors: Robert D. Thulman, 10309 Wilde Lake Ter., Columbia, Md. 21044; Alve J. Erickson, 17 Pleasant St., Milford, N.H. 03055

[**] Term: 14 Years

[21] Appl. No.: 260,089

[22] Filed: May 4, 1981

[51] Int. Cl. D23-03
[52] U.S. Cl. D23/97
[58] Field of Search D23/92-97, D23/105; 126/4, 6, 58, 60-66, 120, 121, 123, 126

[56] References Cited
U.S. PATENT DOCUMENTS

D. 244,199 5/1977 Davis D23/97
D. 255,710 7/1980 Heine D23/97
4,136,662 1/1979 Willson 126/61

Primary Examiner—Catherine E. Kemper
Attorney, Agent, or Firm—Schwartz, Jeffery, Schwaab, Mack, Blumenthal & Koch

[57] CLAIM

The ornamental design for a stove for burning combustible solid fuels, as shown and described.

DESCRIPTION

FIG. 1 is a perspective view of a stove for burning combustible solid fuels, showing our new design; FIG. 2 is a right side elevational view thereof; FIG. 3 is a left side elevational view thereof; FIG. 4 is a front elevational view thereof; FIG. 5 is a rear elevational view thereof; FIG. 6 is a top plan view thereof; FIG. 7 is a bottom view thereof.

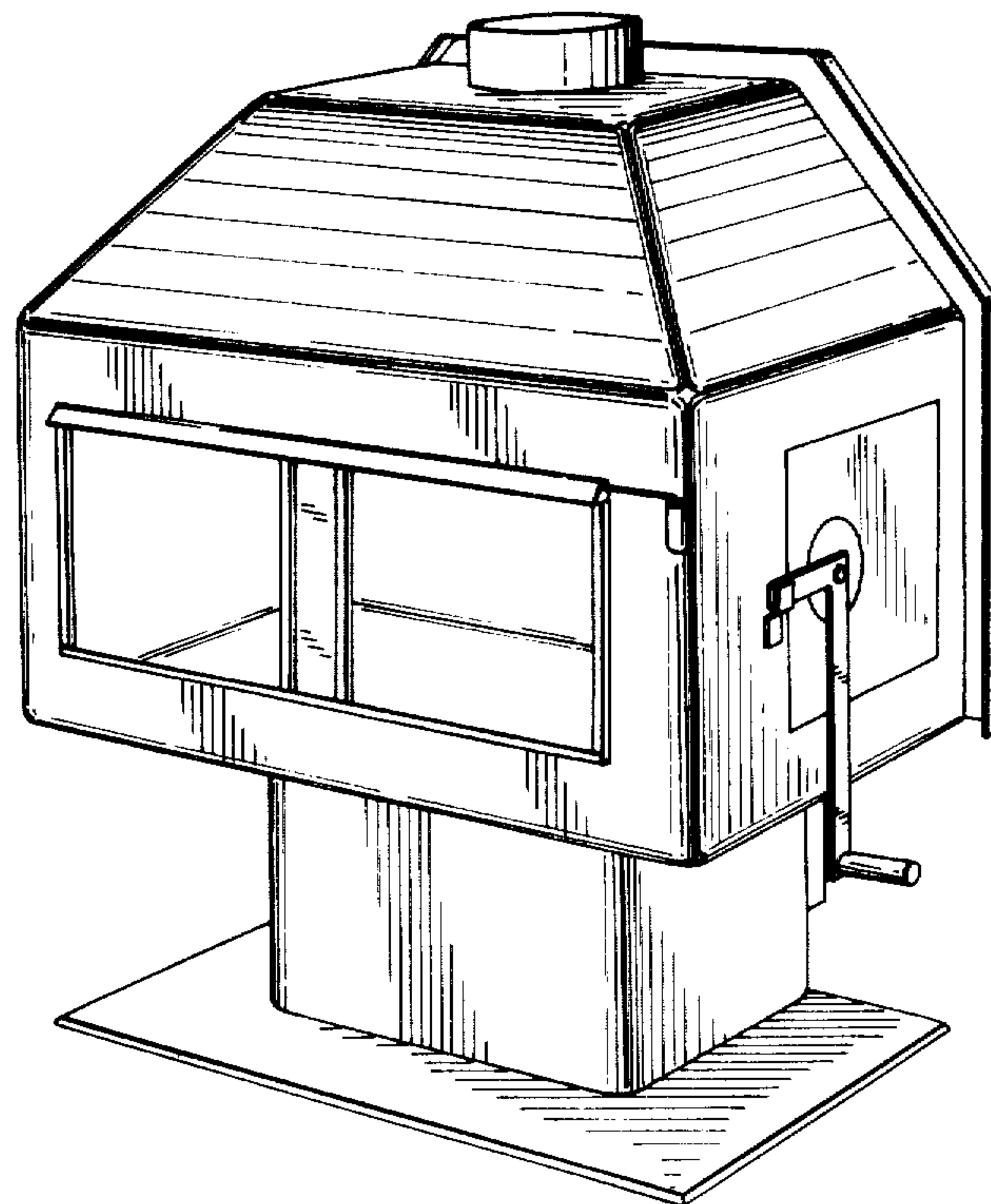

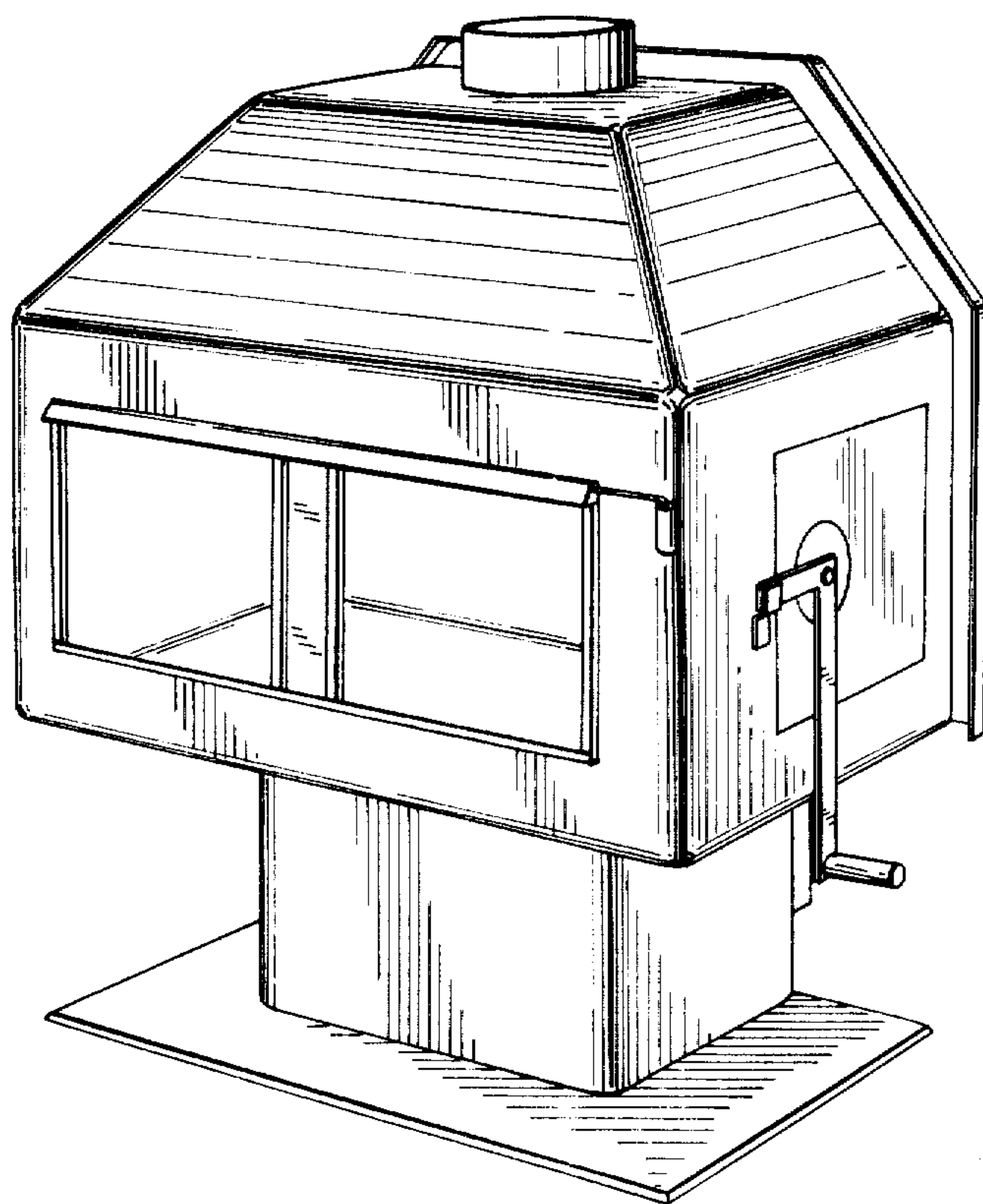

FIG. 1

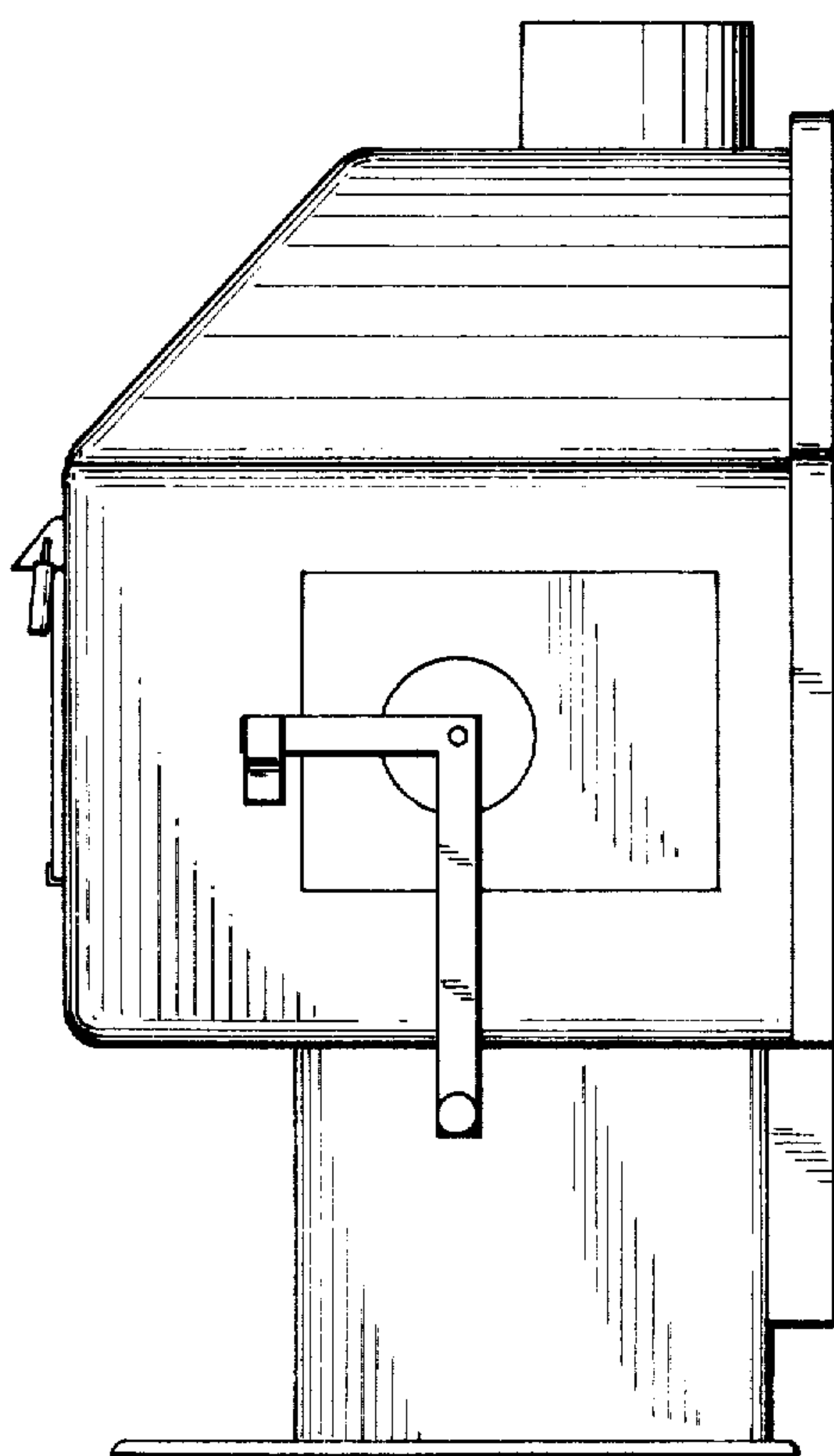

FIG. 2

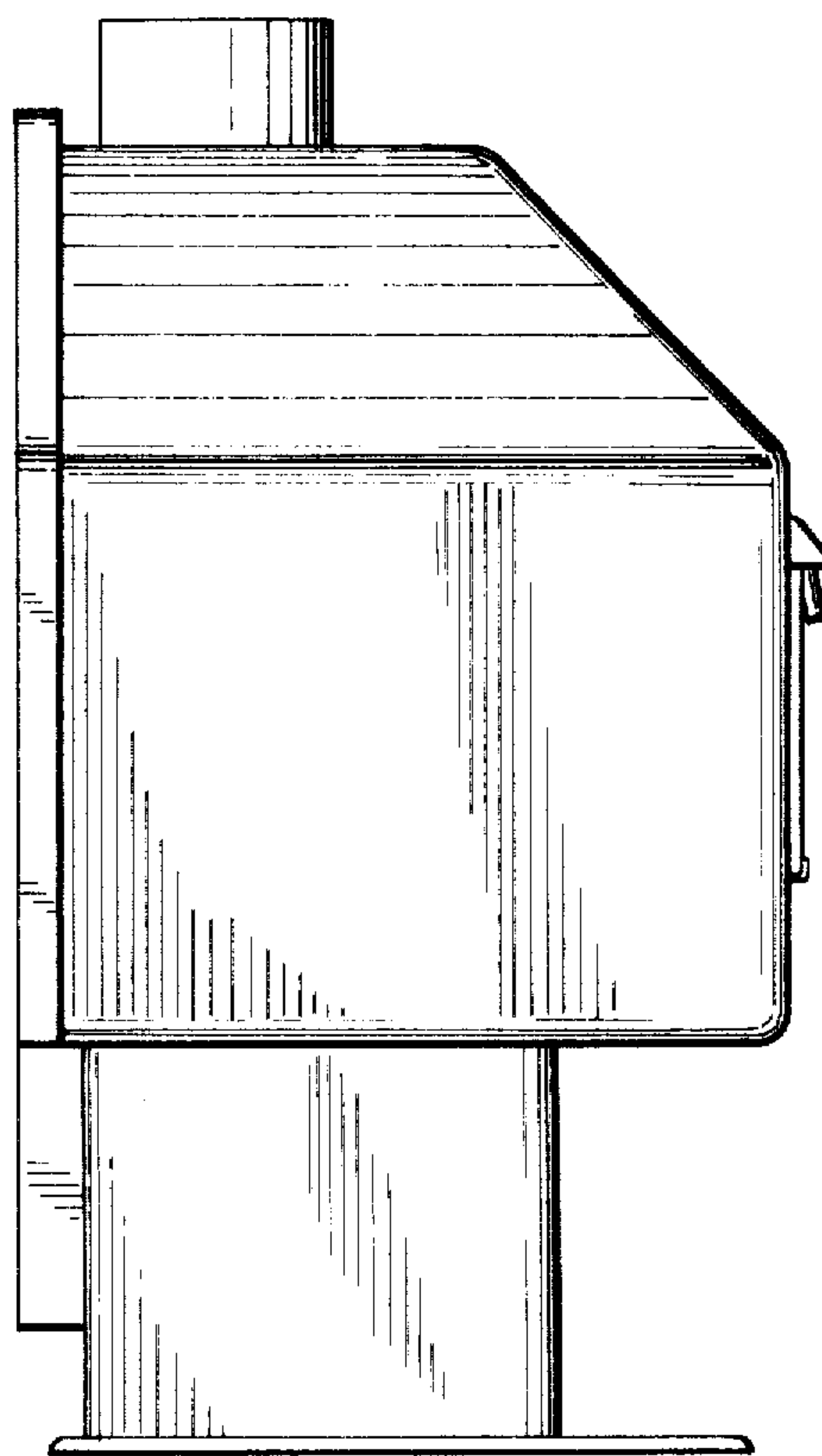

FIG. 3

FIG. 4

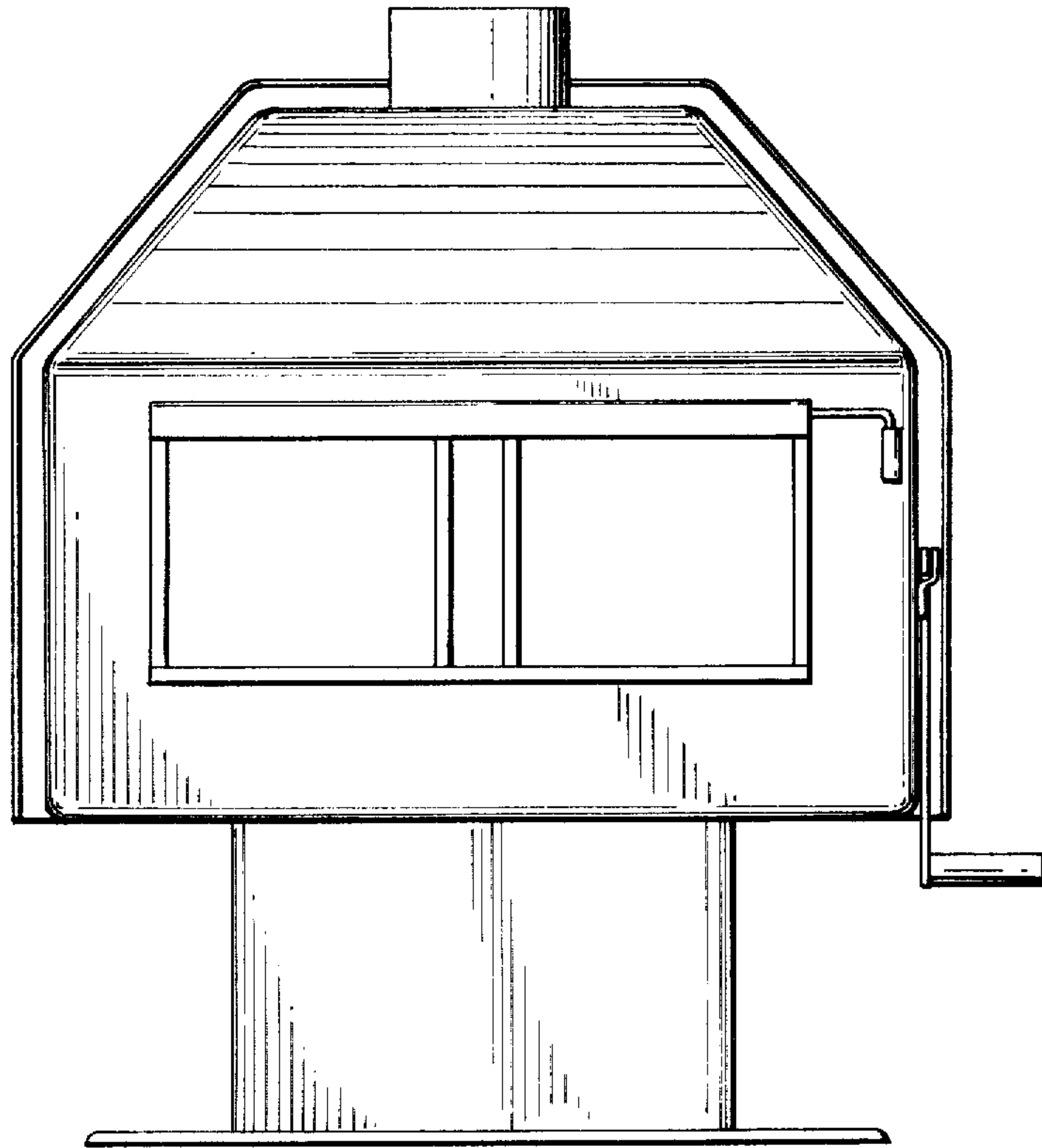
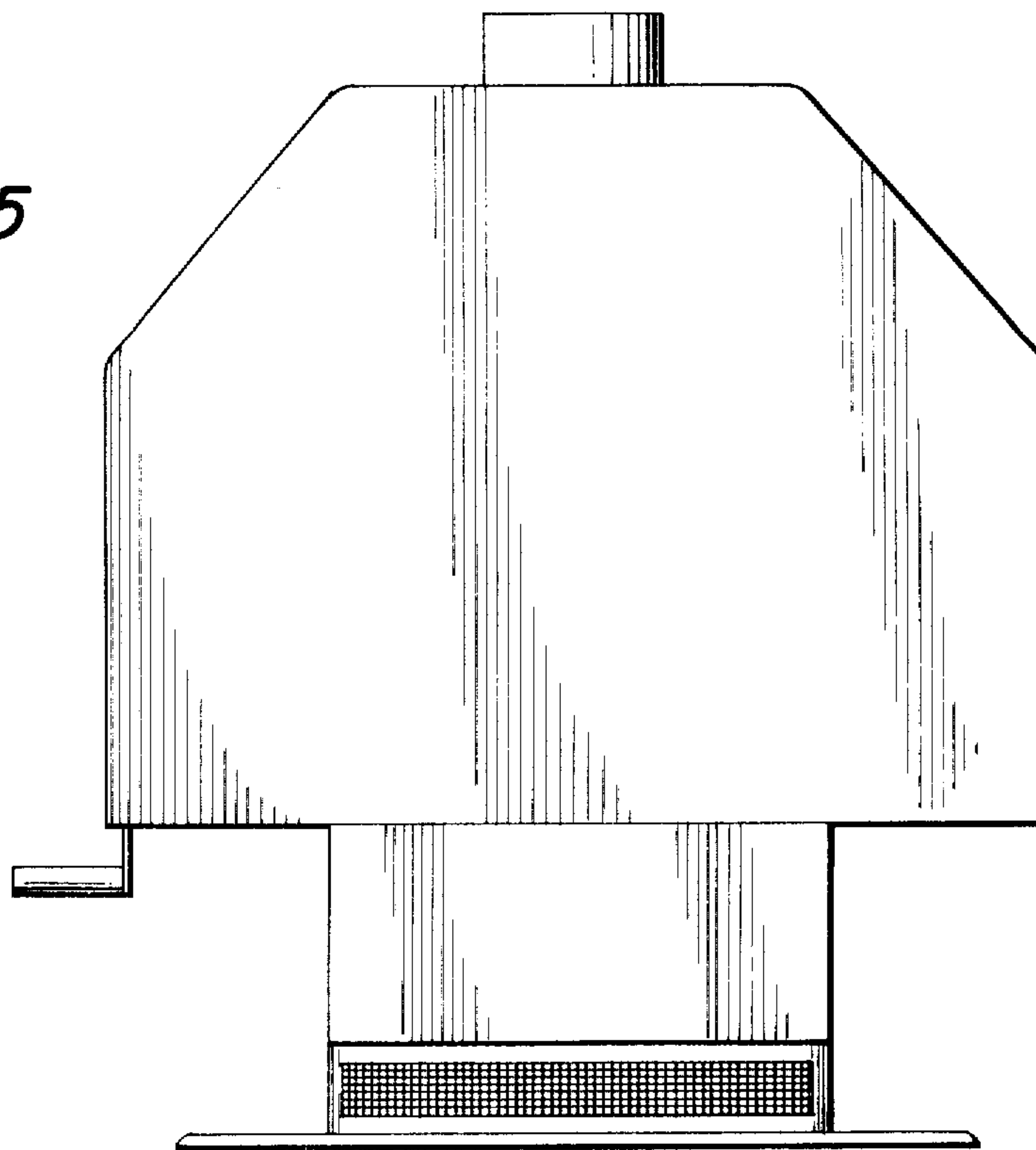

FIG. 5



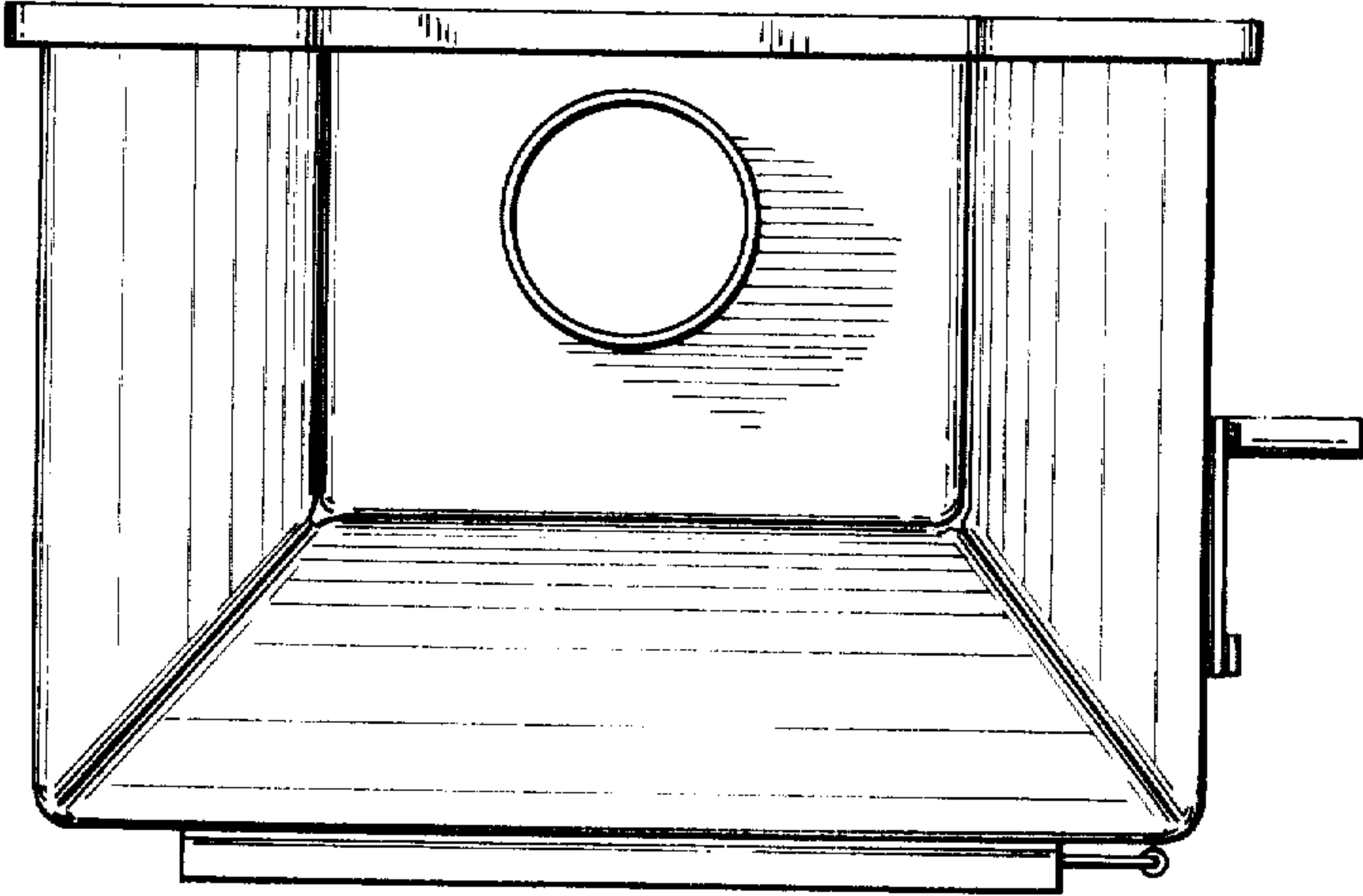

FIG. 6

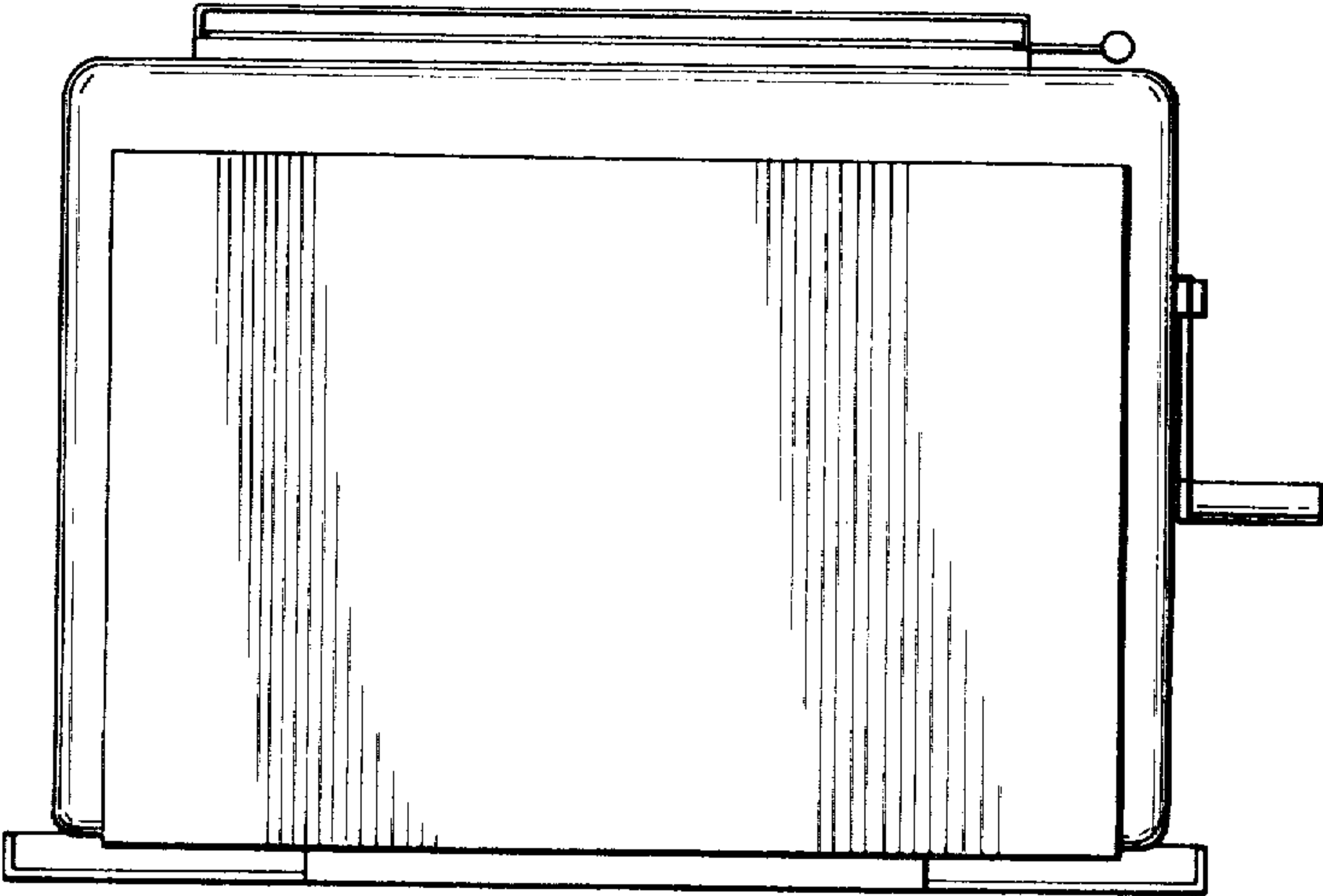

FIG. 7