

[54] WOOD BURNING STOVE

[75] Inventors: Larry A. Schwartz, Warwick; Robert Geiter, Coventry; Peter S. Albertsen, Quidnesset, all of R.I.

[73] Assignee: Jamestown Group, Providence, R.I.

[**] Term: 14 Years

[21] Appl. No.: 187,220

[22] Filed: Sep. 15, 1980

[51] Int. Cl. D23-03

[52] U.S. Cl. D23/97

[58] Field of Search D23/92-97;
126/4, 6, 58, 60-66, 120, 121, 123, 126

[56] References Cited

U.S. PATENT DOCUMENTS

4,230,091 10/1980 Judge et al. 126/60 X
4,265,213 5/1981 Gorsuch et al. 126/66

Primary Examiner—Catherine E. Kemper
Attorney, Agent, or Firm—Salter & Michaelson

[57] CLAIM

The ornamental design for a wood burning stove, substantially as shown.

DESCRIPTION

FIG. 1 is a perspective view of a wood burning stove showing our new design;
FIG. 2 is a front elevational view thereof;
FIG. 3 is a top plan view thereof;
FIG. 4 is a right side elevational view thereof;
FIG. 5 is a left side elevational view thereof;
FIG. 6 is a bottom plan thereof; and
FIG. 7 is a rear elevational view thereof.

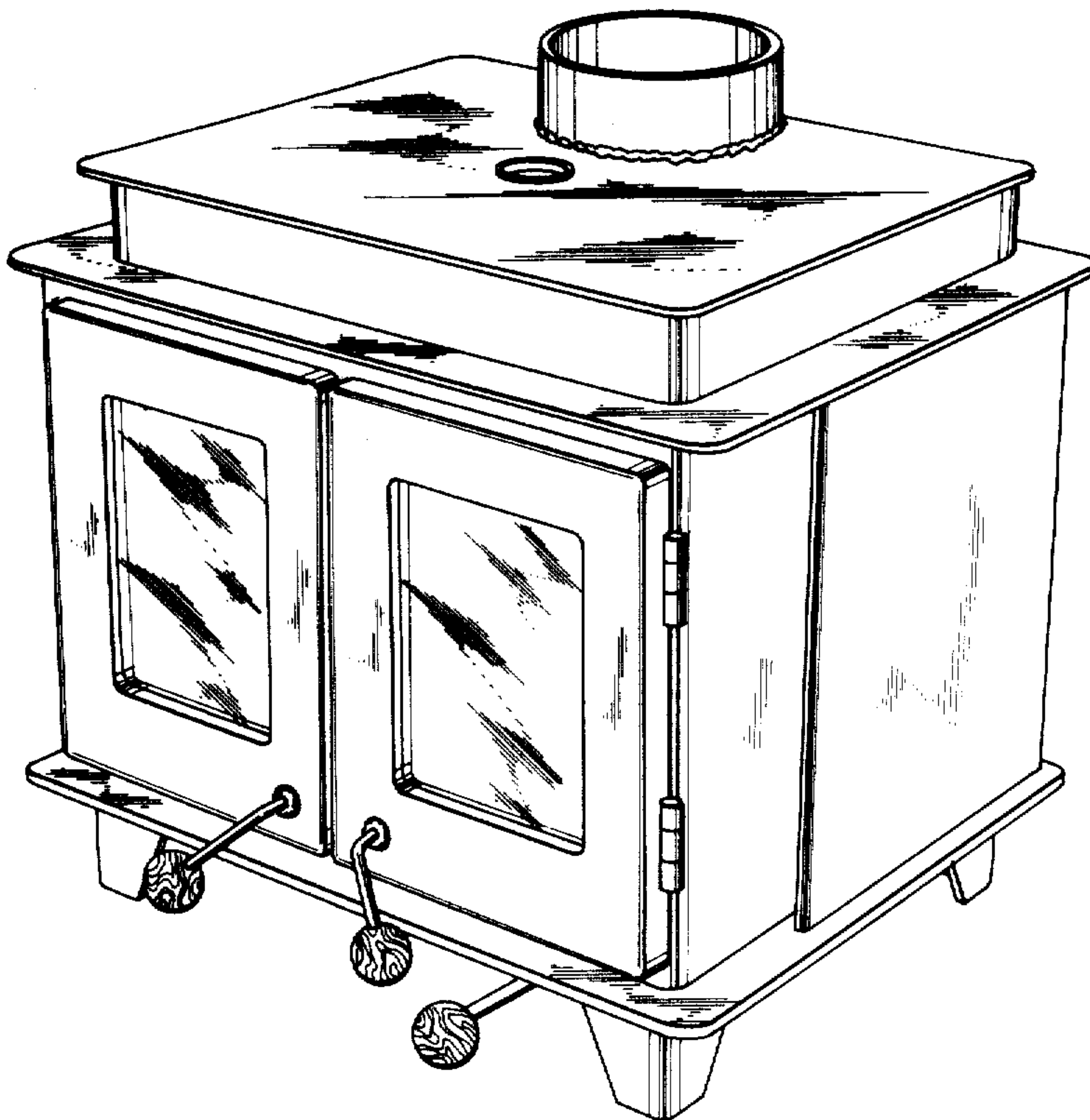

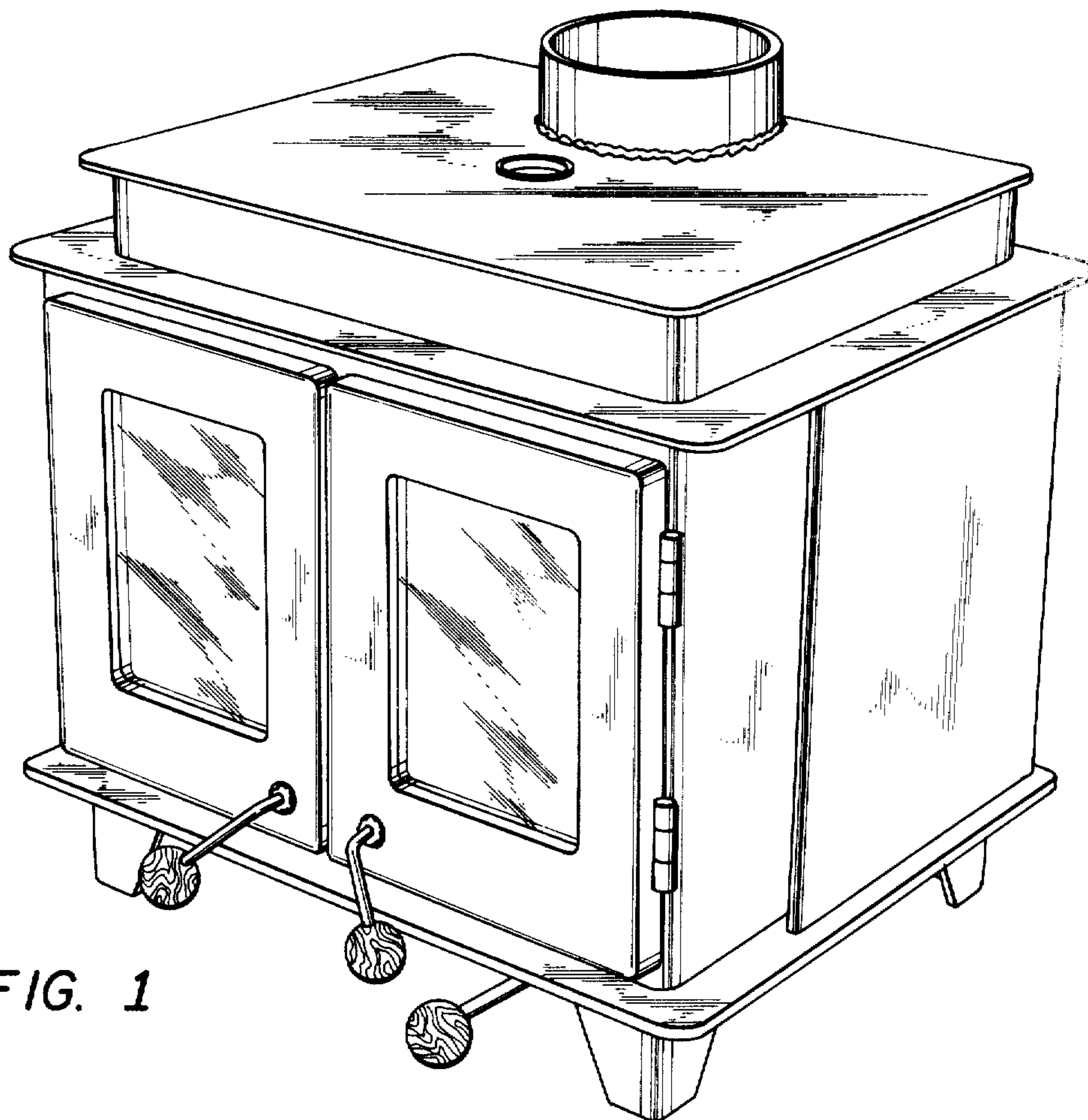

FIG. 1

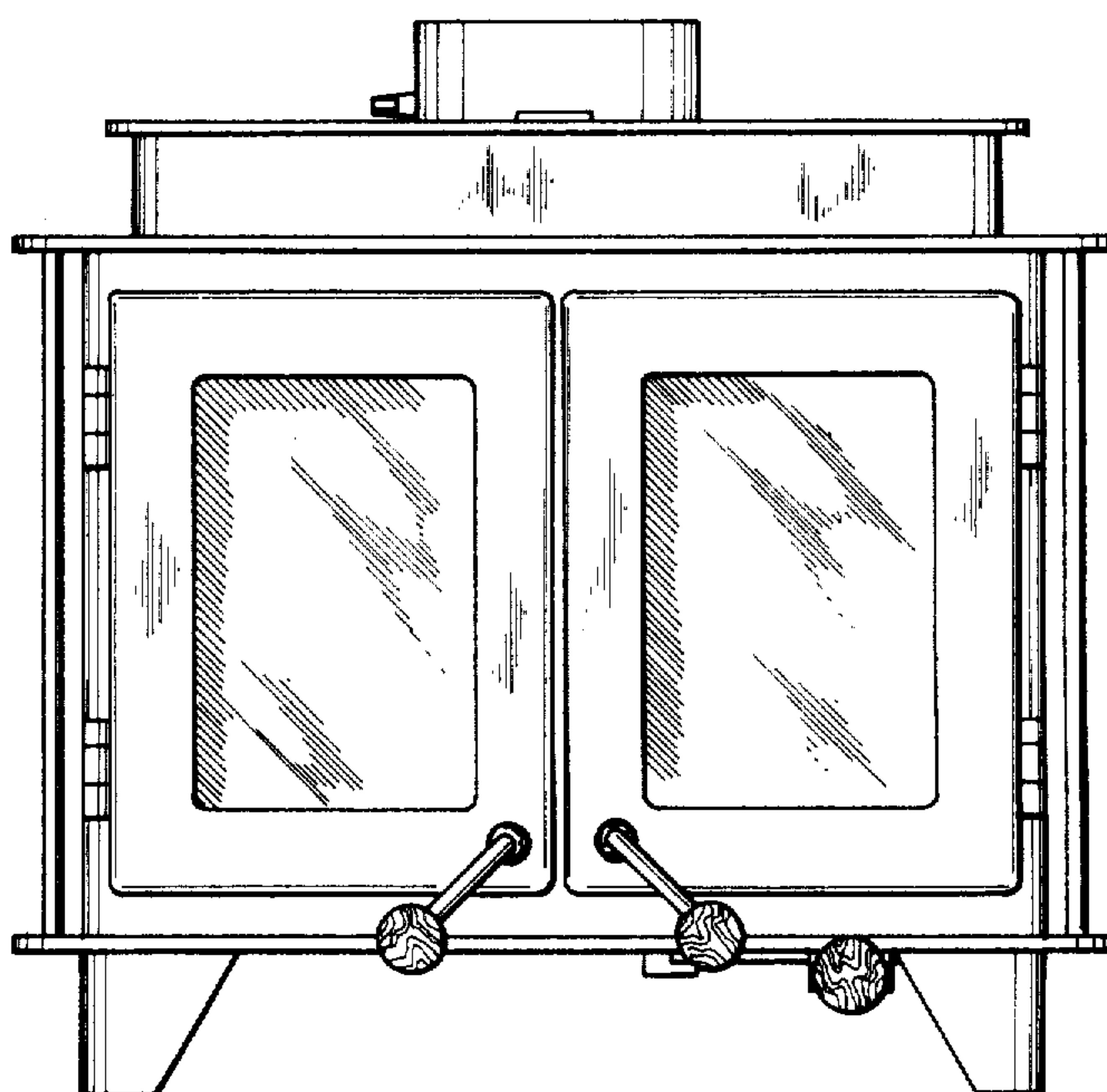

FIG. 2

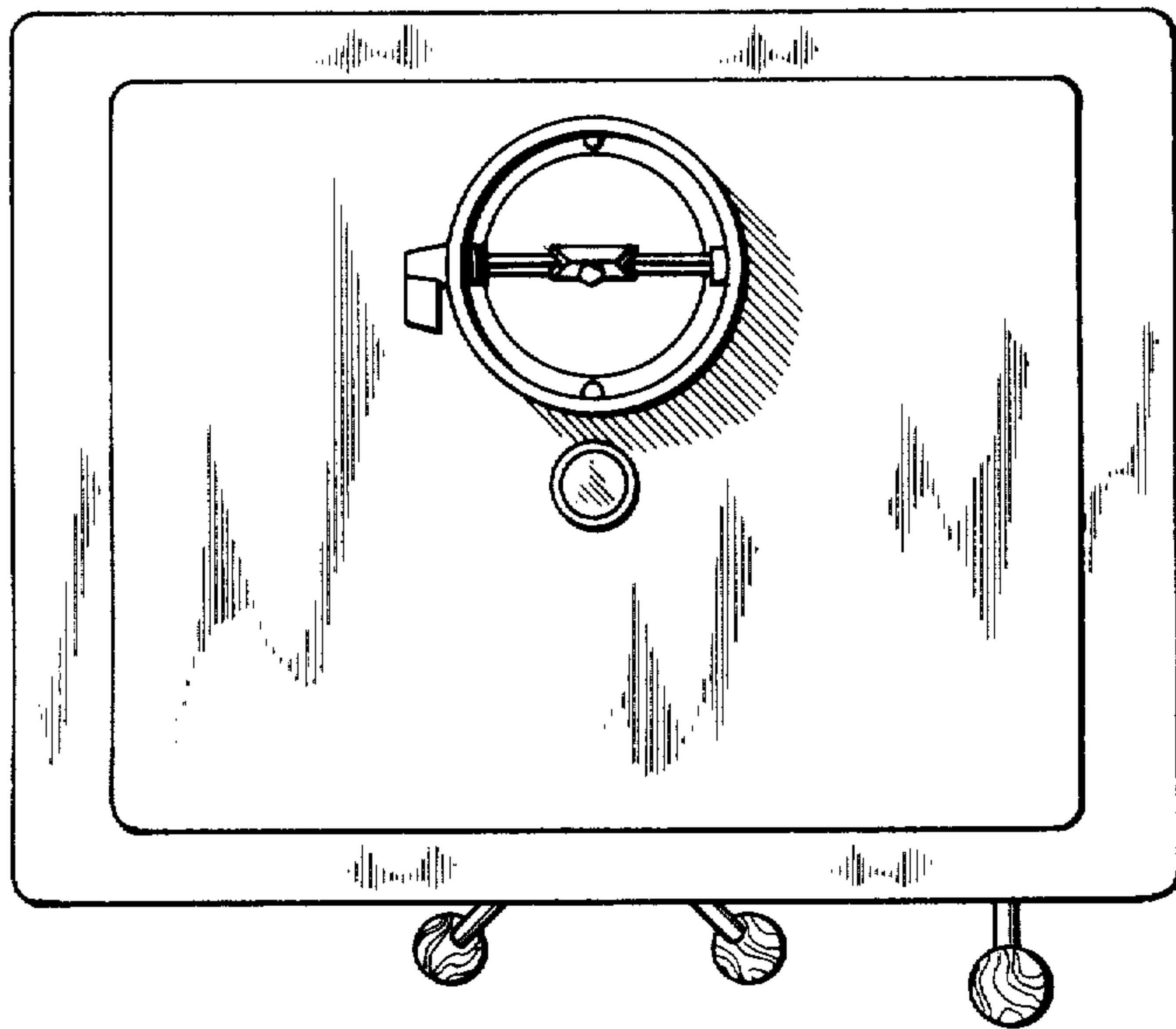

FIG. 3

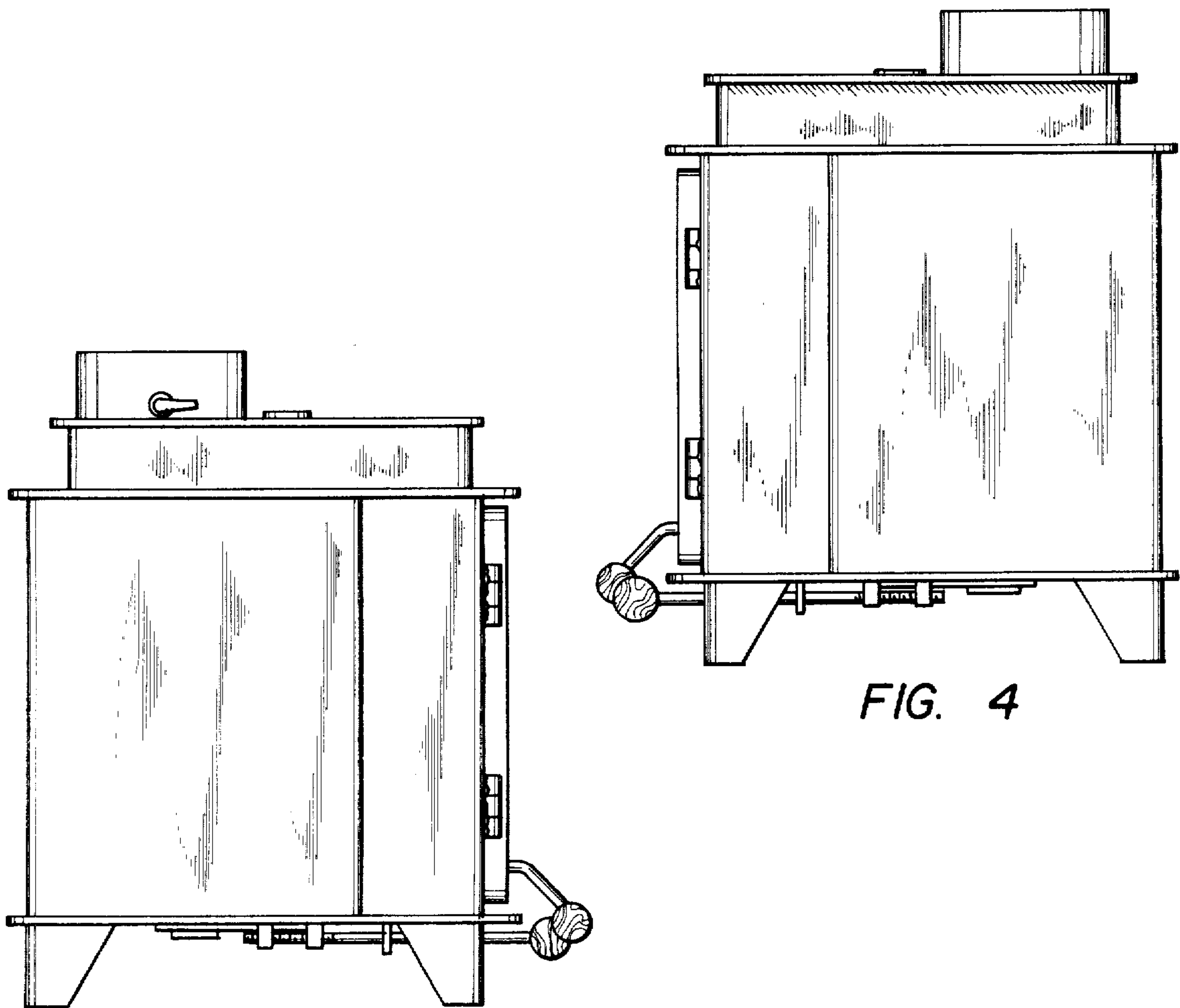

FIG. 4

FIG. 5

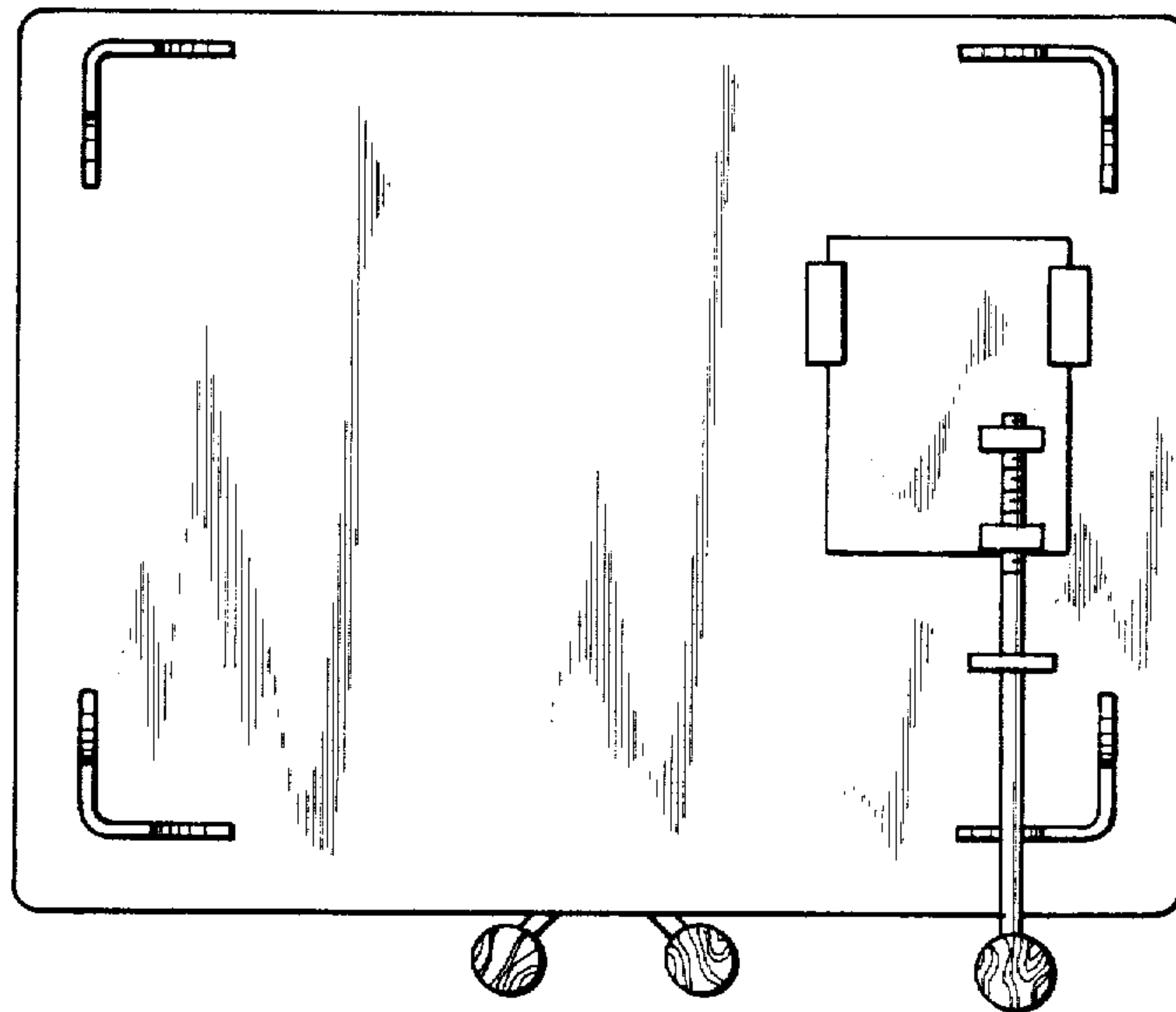

FIG. 6

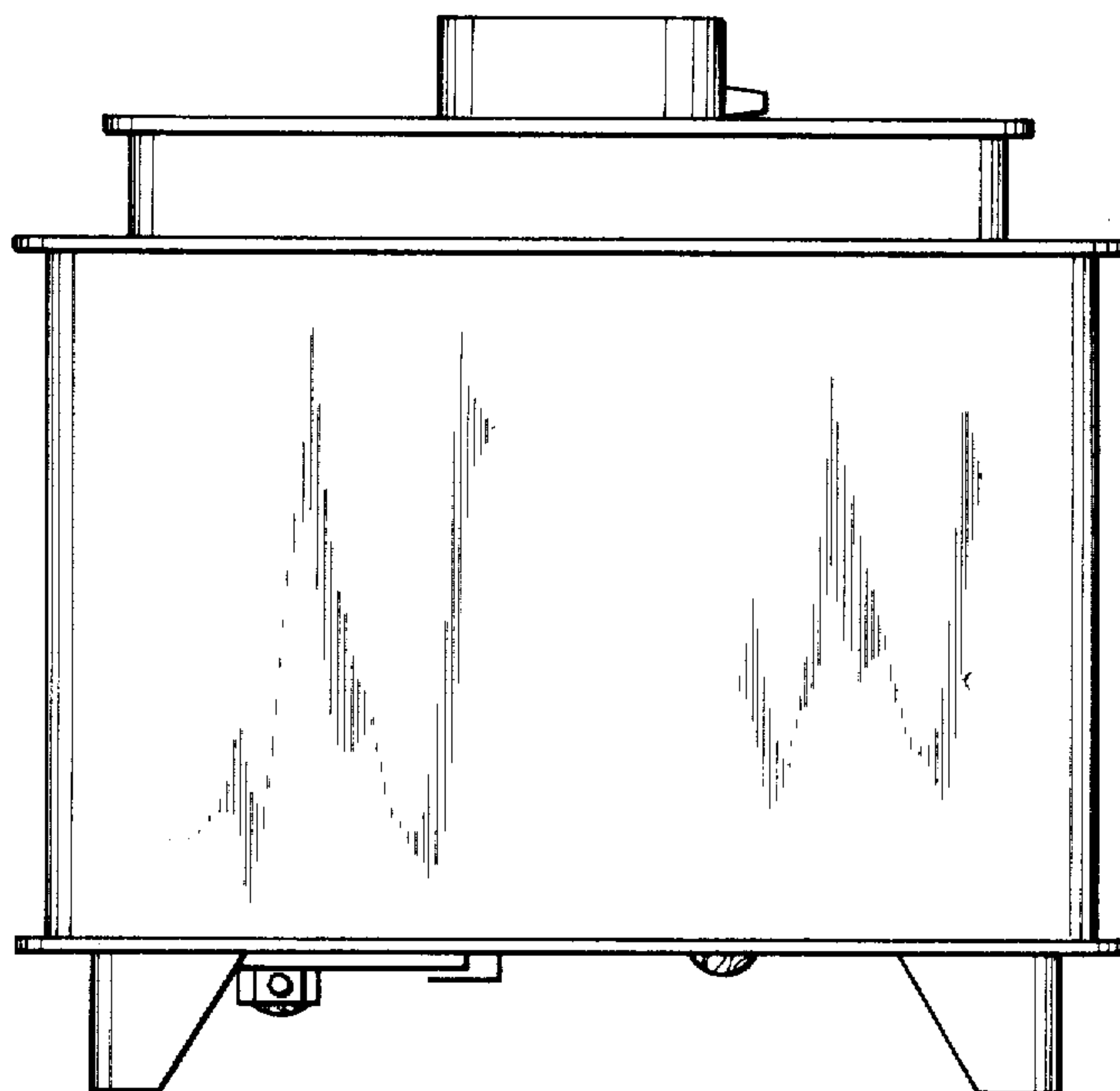

FIG. 7