

[54] COMBINED SUPPORT SURFACE AND PEDESTAL FOR A LAVATORY

[75] Inventor: Jack N. Kaiser, Danville, Ky.

[73] Assignee: American Standard Inc., New York, N.Y.

[**] Term: 14 Years

[21] Appl. No.: 172,880

[22] Filed: Jul. 28, 1980

[51] Int. Cl. D23-02

[52] U.S. Cl. D23/70; D23/61

[58] Field of Search D23/48, 58-64, D23/69-71; 4/619, 624, 631, 635, 636

[56] References Cited

U.S. PATENT DOCUMENTS

D. 75,582	6/1928	McFeely	D23/61
D. 78,257	4/1929	Bonner, Jr.	D23/61
D. 215,291	9/1969	Owings	D23/58
D. 258,079	1/1981	Primault	D23/61

OTHER PUBLICATIONS

Stile Industria, Oct. 1960, p. VII.

Primary Examiner—James R. Largen

Attorney, Agent, or Firm—James J. Salerno, Jr.; Robert G. Crooks; John P. Sinnott

[57] CLAIM

The ornamental design for a combined support surface and pedestal for a lavatory, substantially as shown and described.

DESCRIPTION

FIG. 1 is a front elevational view of a combined support surface and pedestal for a lavatory showing my new design;

FIG. 2 is a top plan view thereof;

FIG. 3 is a right side elevational view thereof, the left side being a mirror image of the right side shown;

FIG. 4 is a rear elevational view thereof;

FIG. 5 is a bottom plan view thereof;

FIG. 6 is a front elevational view of the support surface portion thereof;

FIG. 7 is a top plan view of FIG. 6;

FIG. 8 is a right side elevational view of FIG. 6, the left side being a mirror image of the right side shown;

FIG. 9 is a rear elevational view of FIG. 6;

FIG. 10 is a bottom plan view of FIG. 6;

FIG. 11 is a front elevational view of the pedestal portion thereof;

FIG. 12 is a right side elevational view of FIG. 11, the left side being a mirror image of the right side shown;

FIG. 13 is a rear elevational view of FIG. 11;

FIG. 14 is a top plan view of FIG. 11; and

FIG. 15 is a bottom plan view of FIG. 11.

The broken line representation of a lavatory in FIGS. 2 and 7 are for purposes of illustration only.

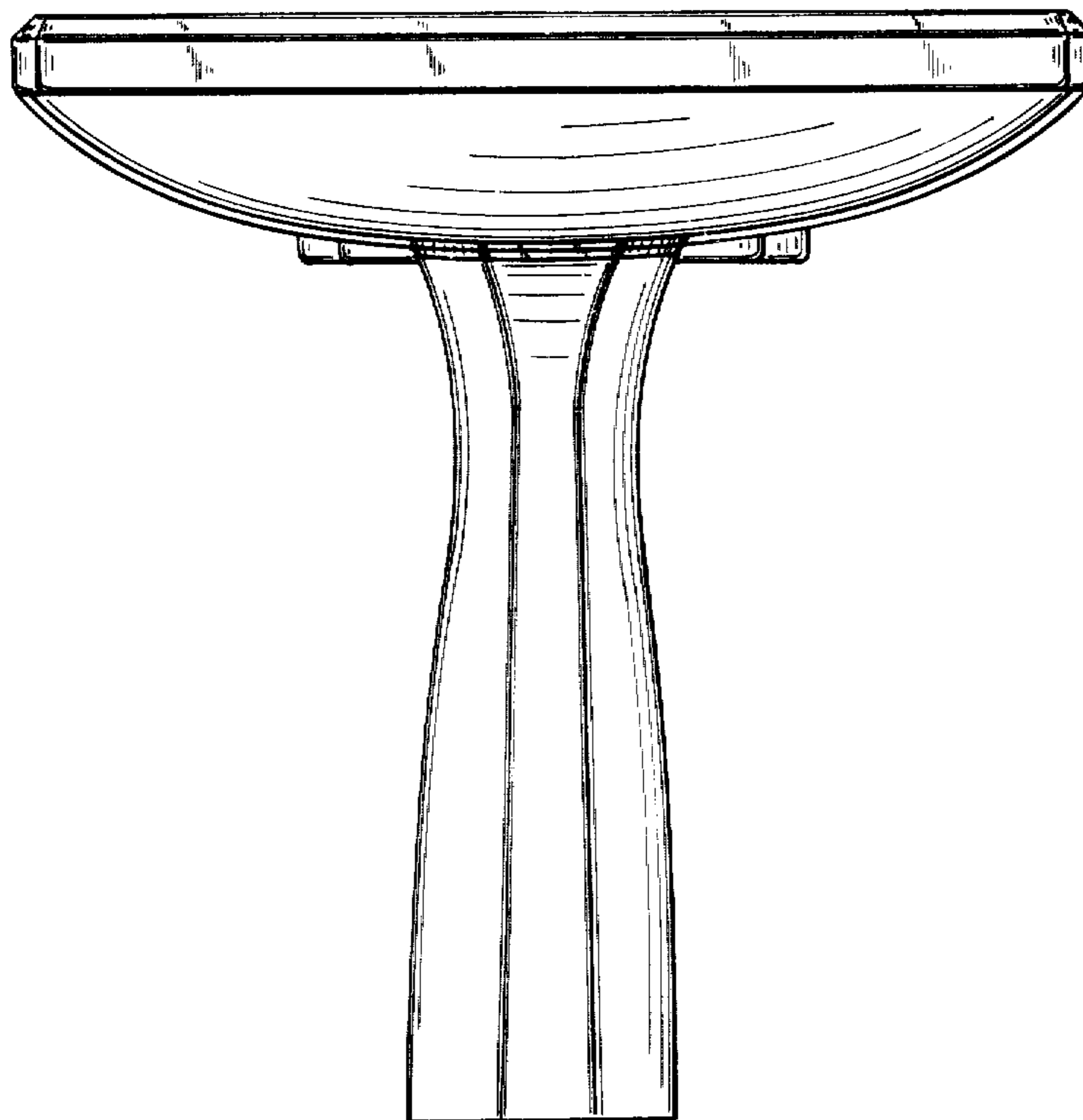

FIG. 1

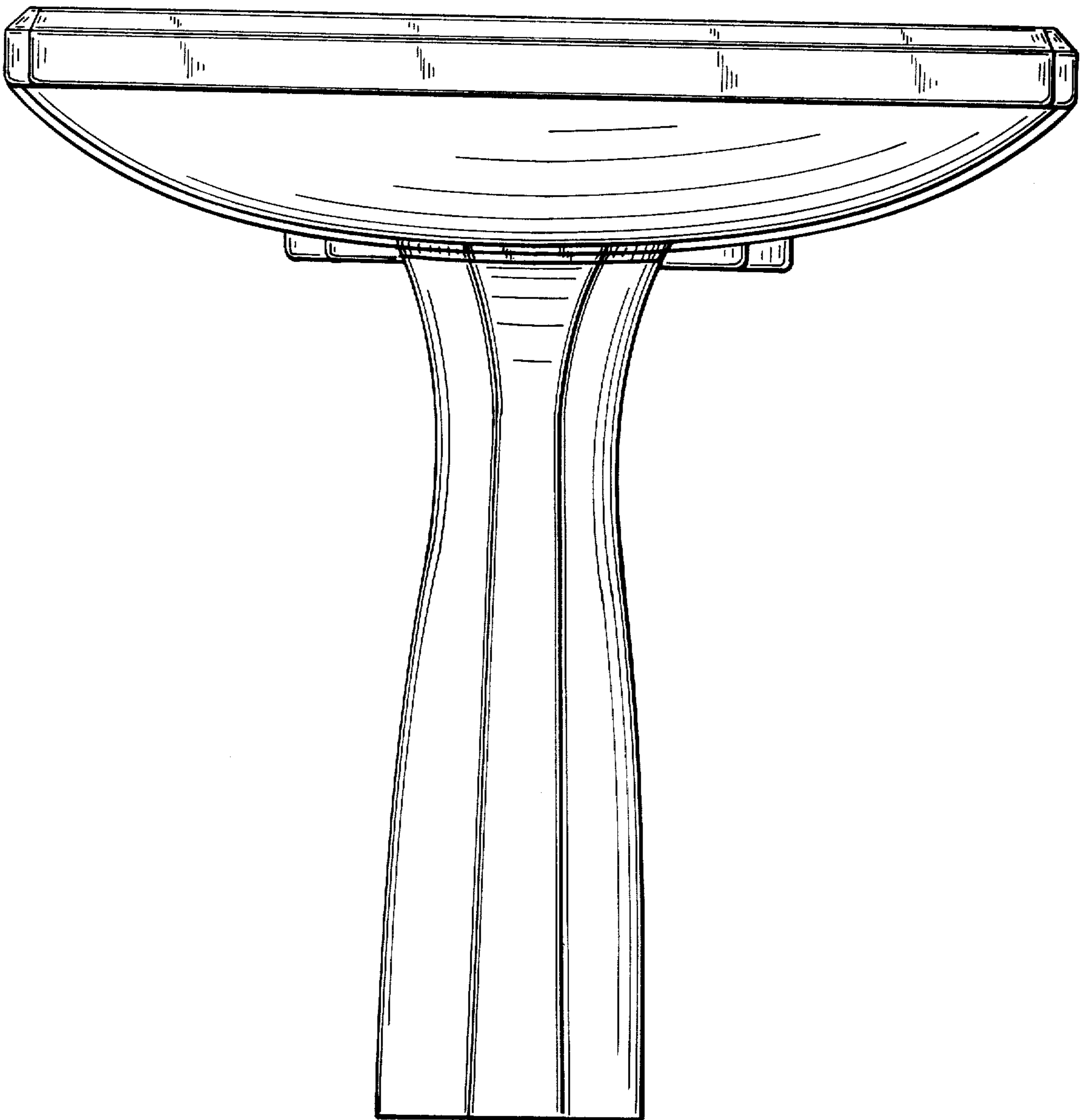
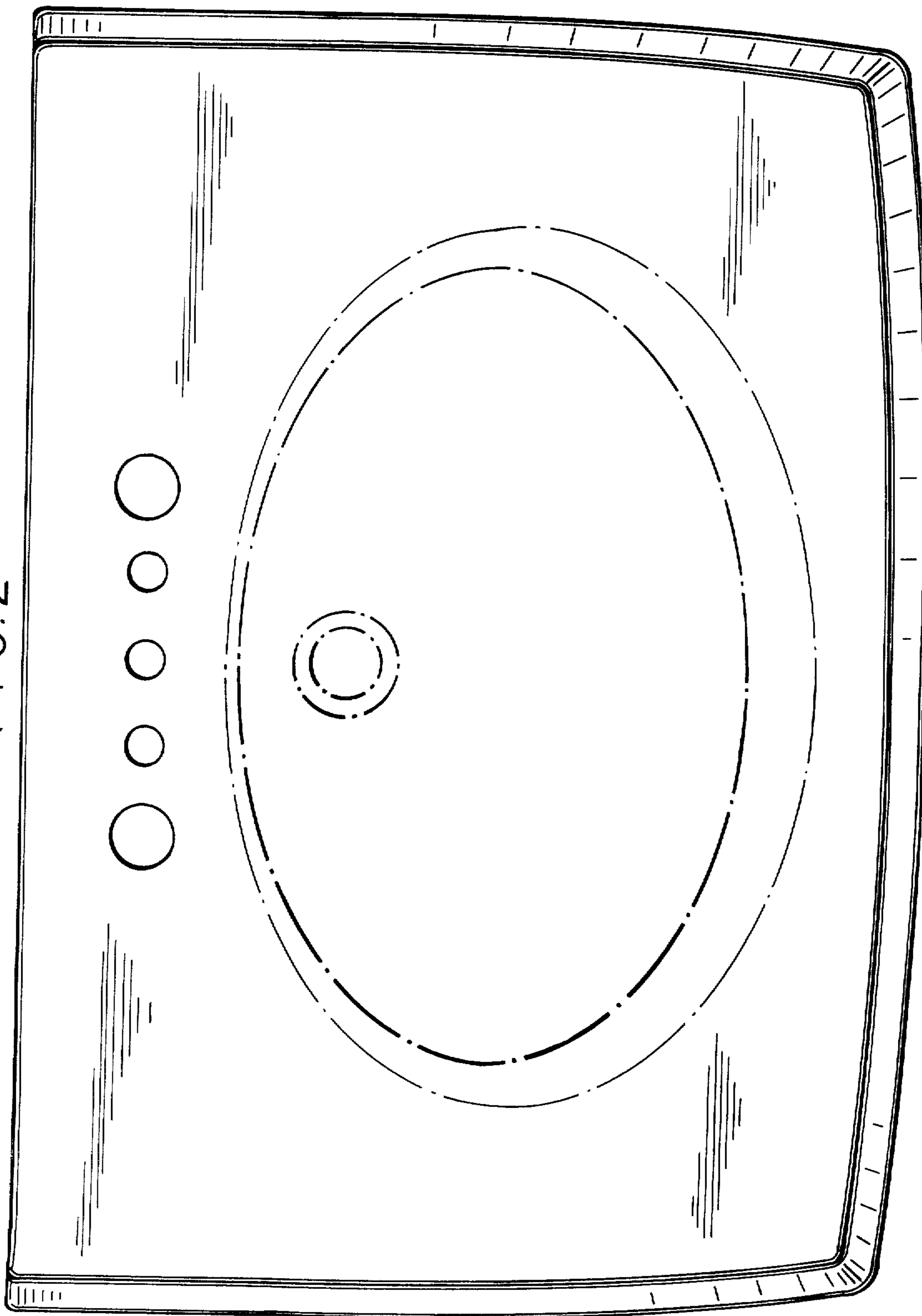

FIG. 2



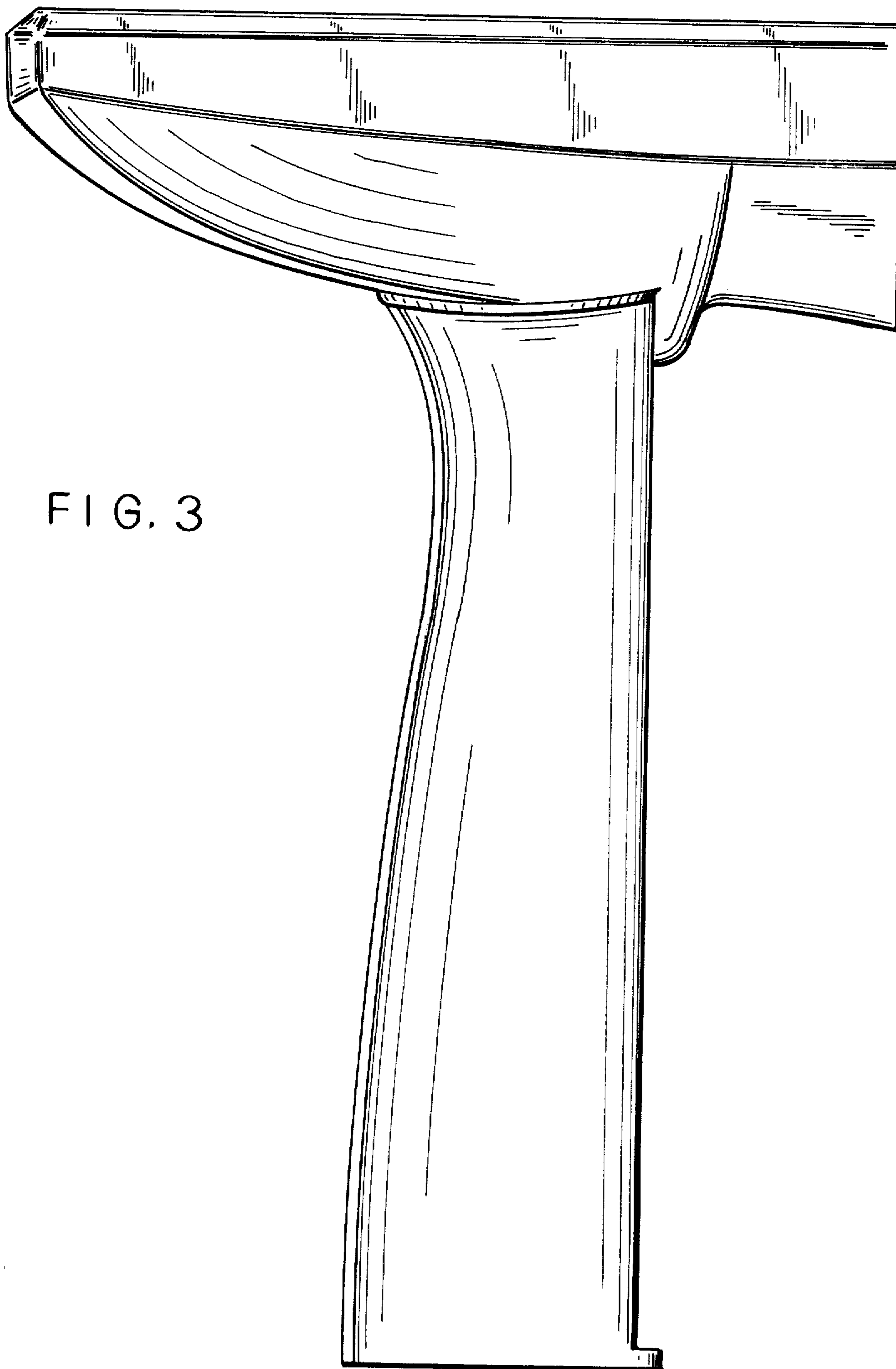

FIG. 3

FIG. 4

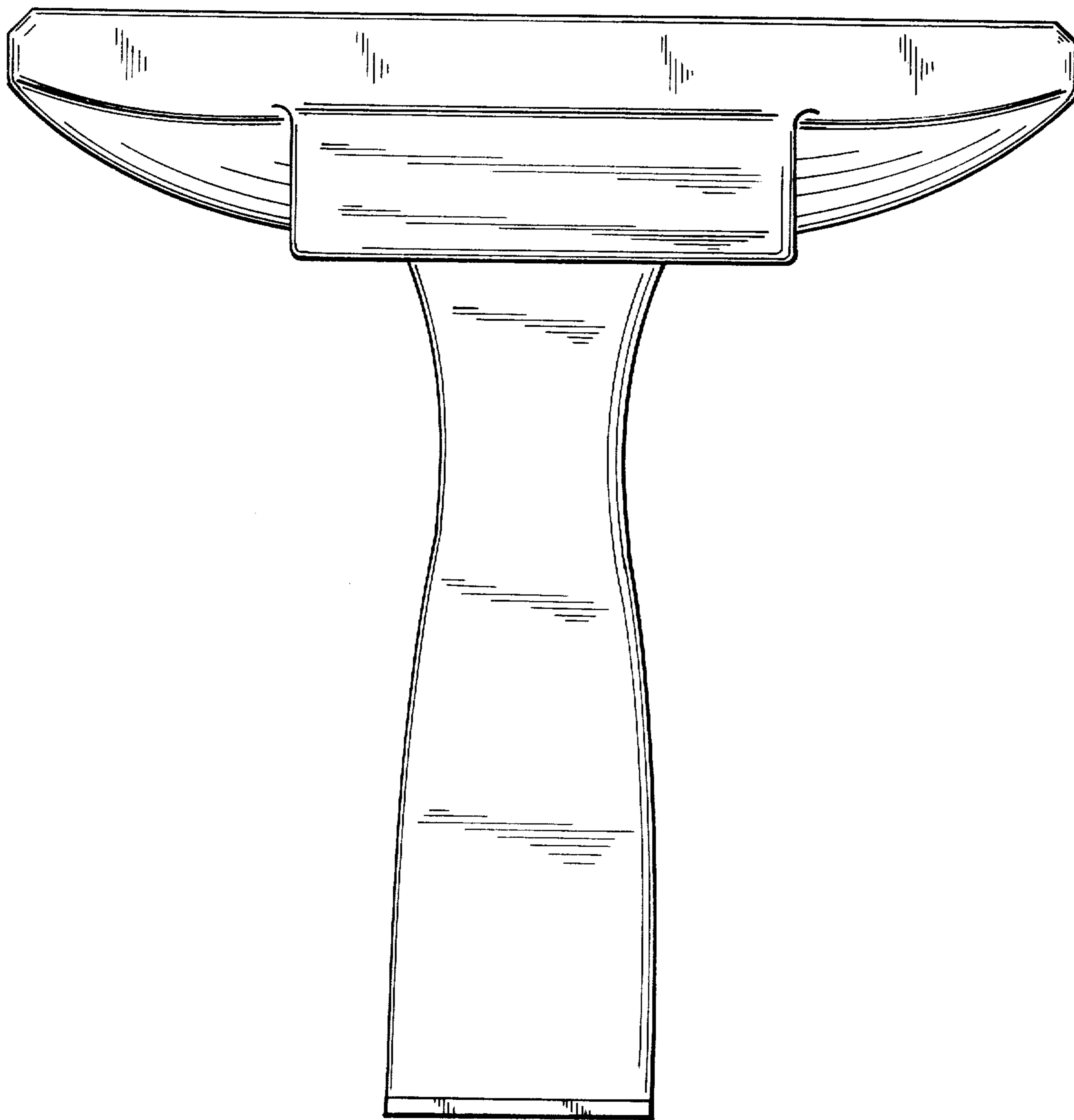

FIG. 5

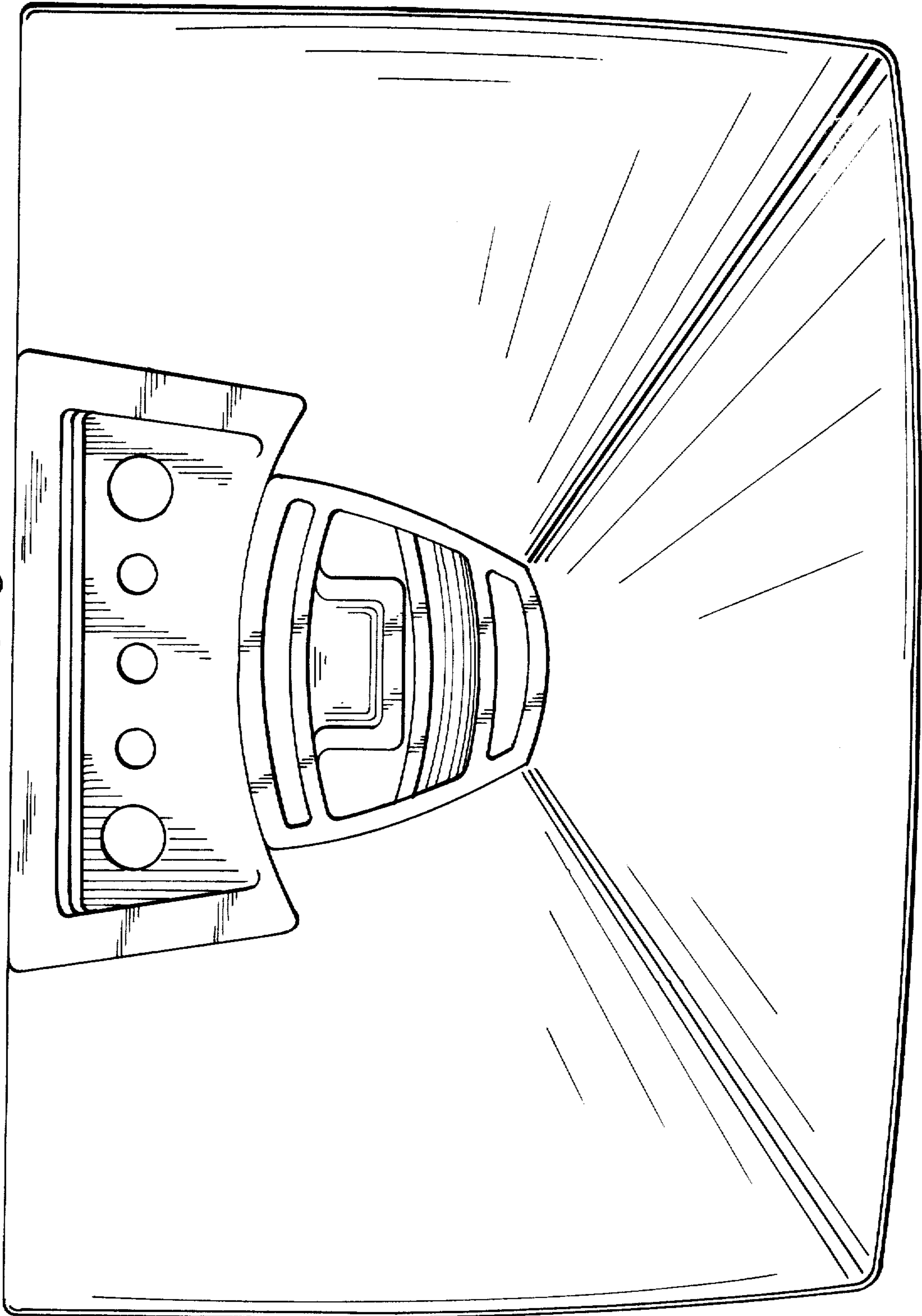

FIG. 6

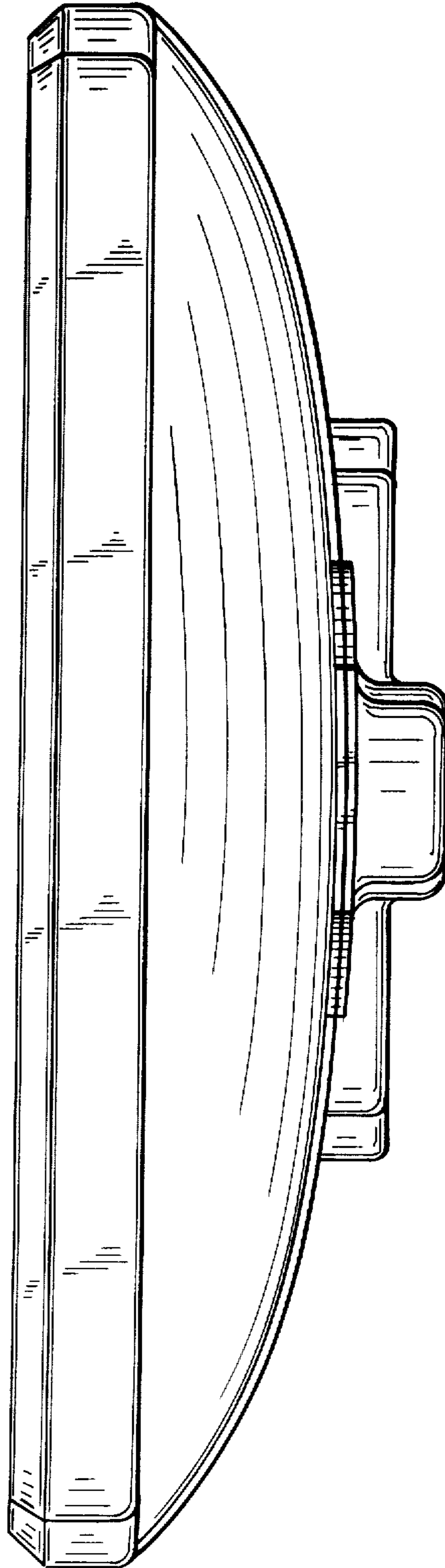

FIG. 7

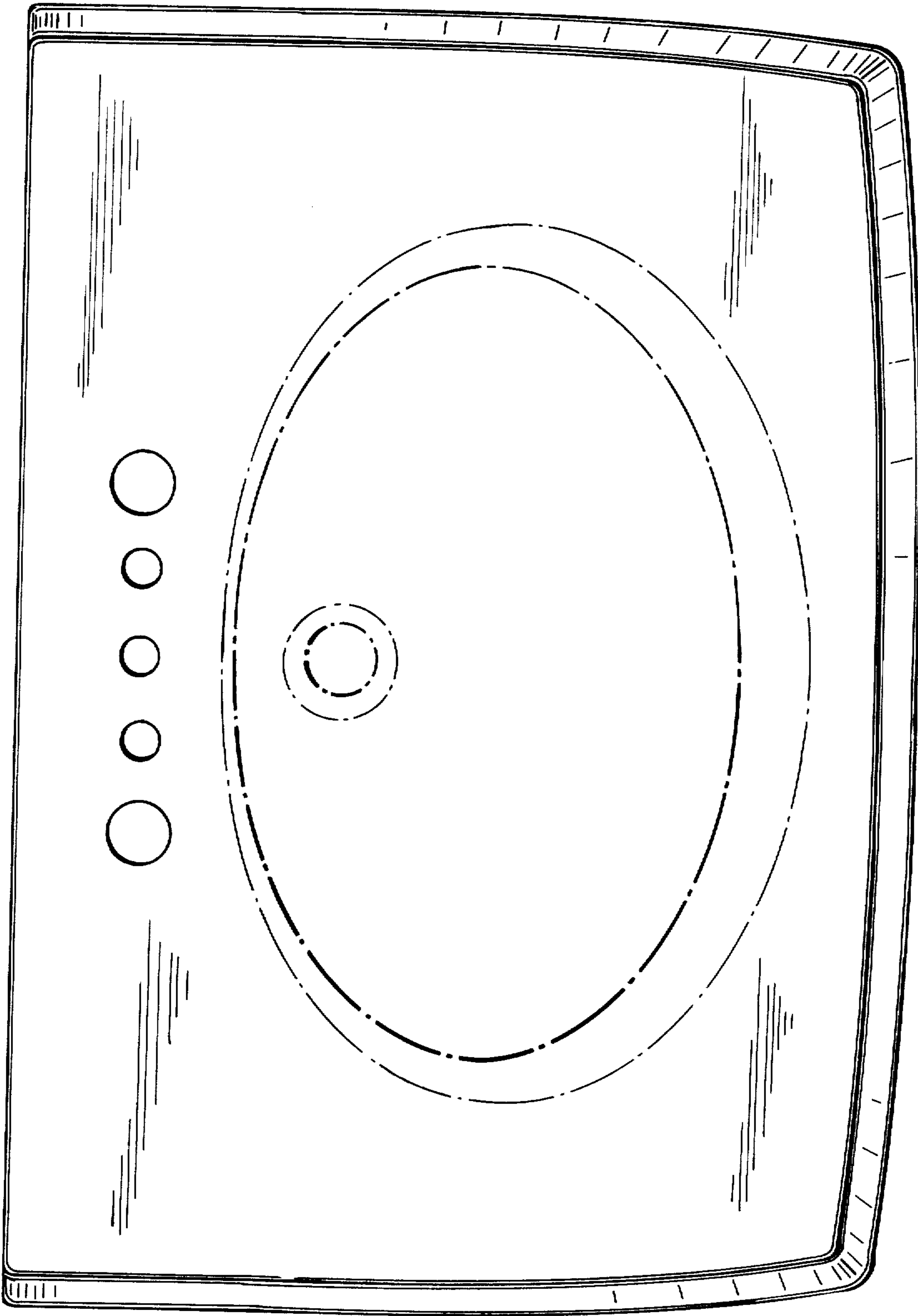

FIG. 8

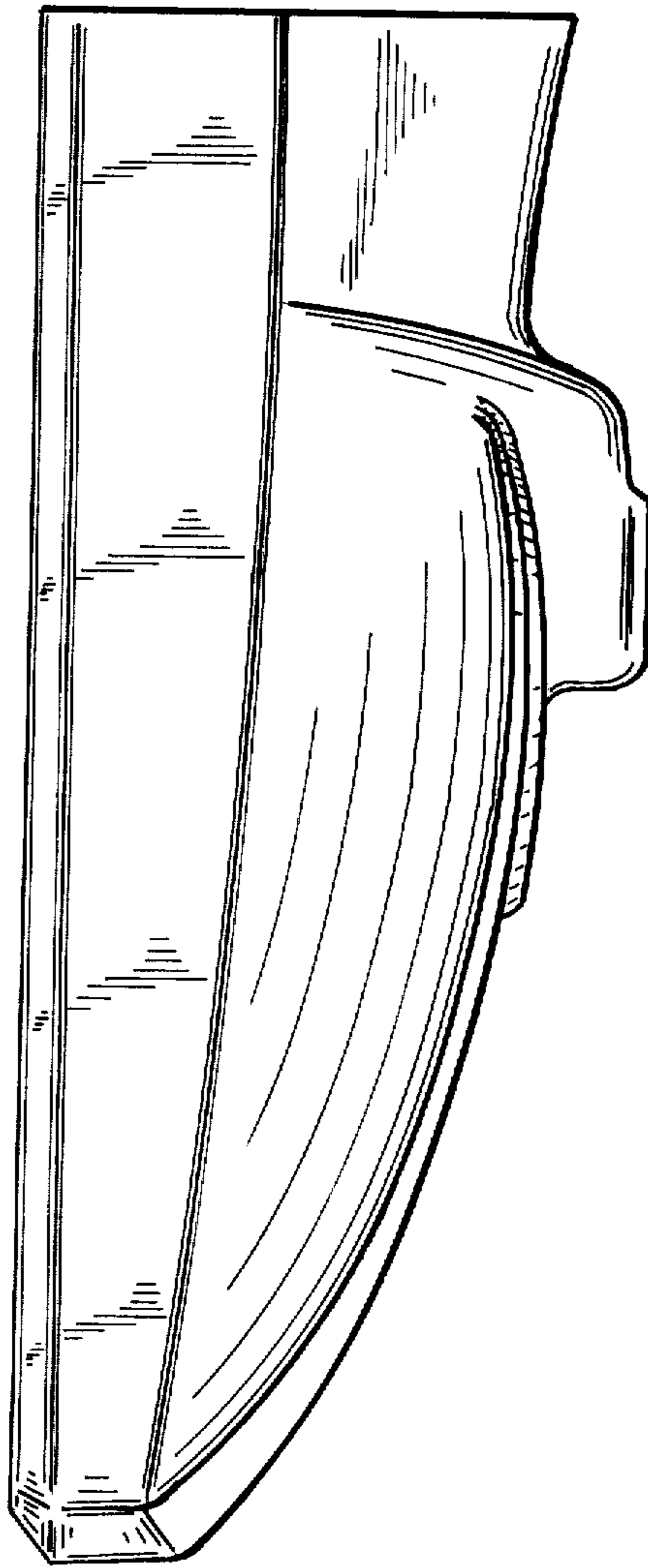

FIG. 9

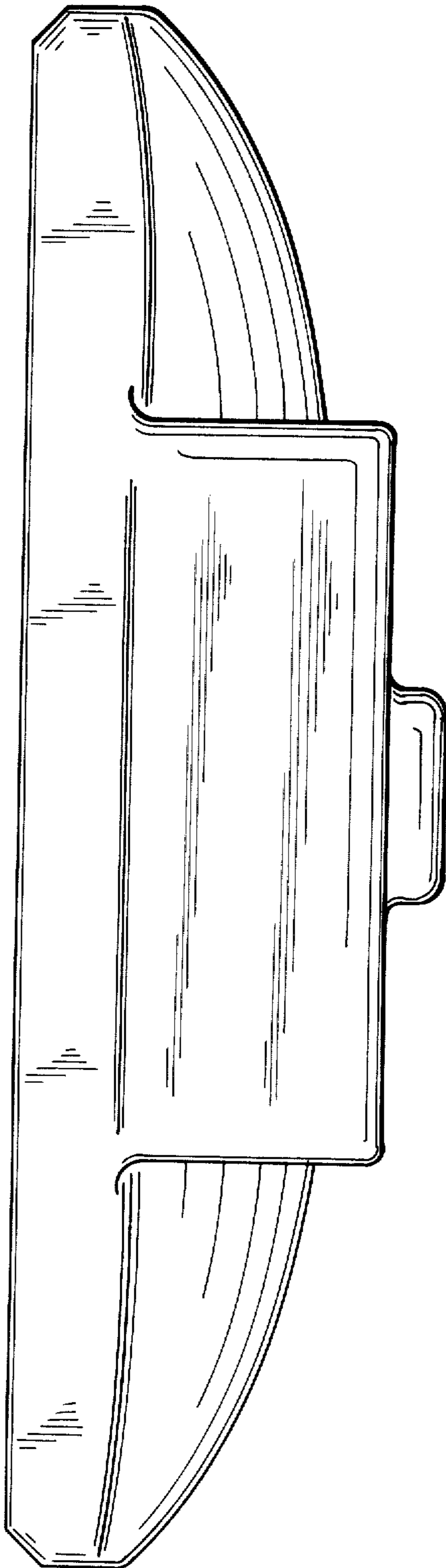

FIG. 10

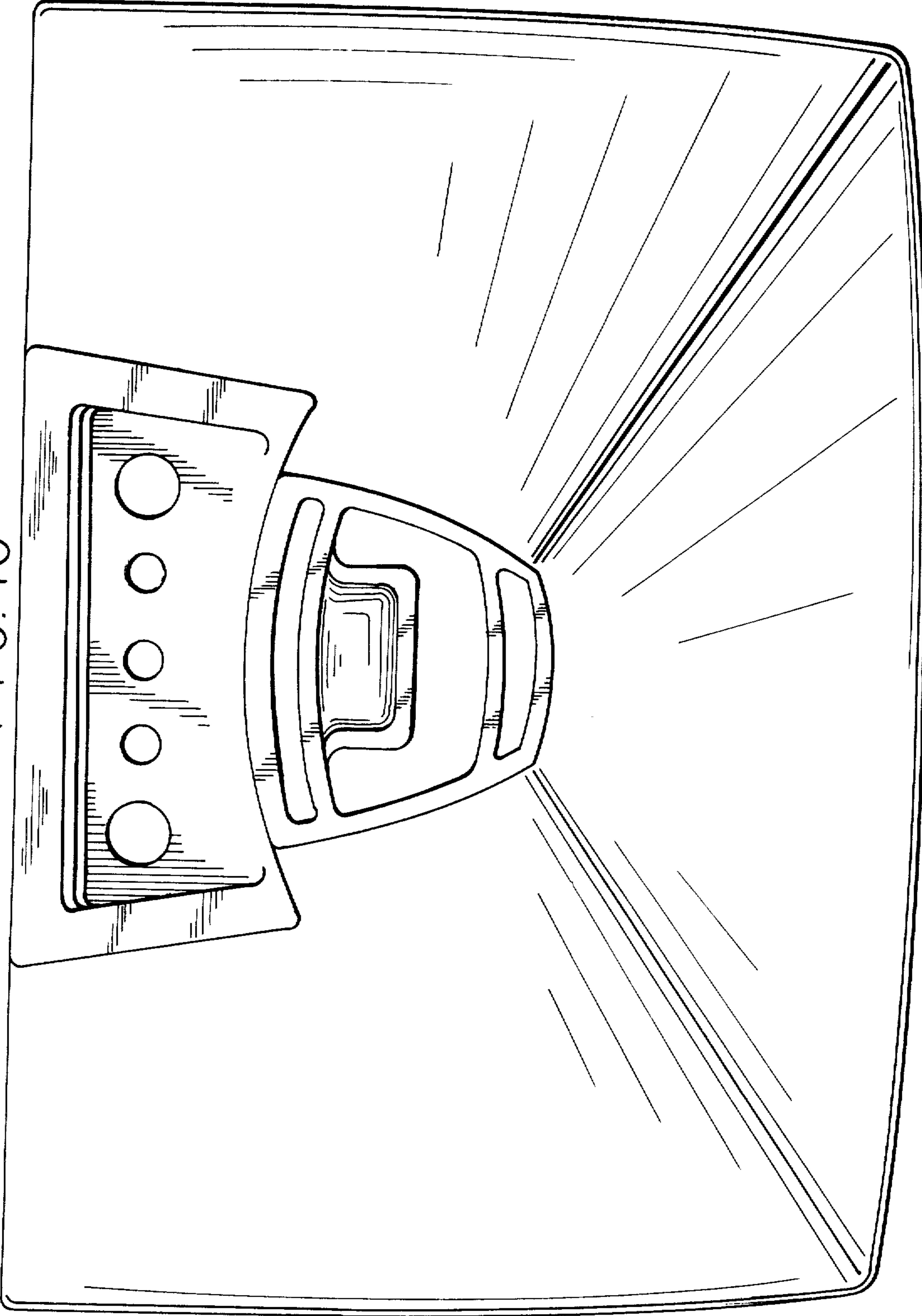

FIG. 11

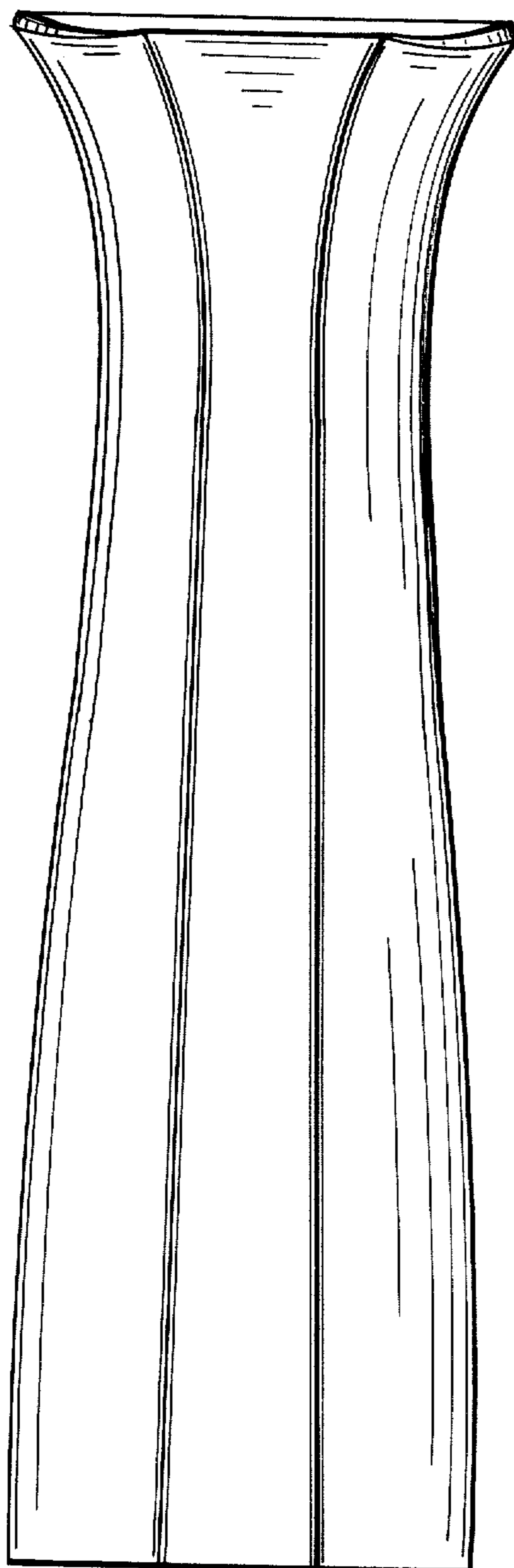

FIG. 12

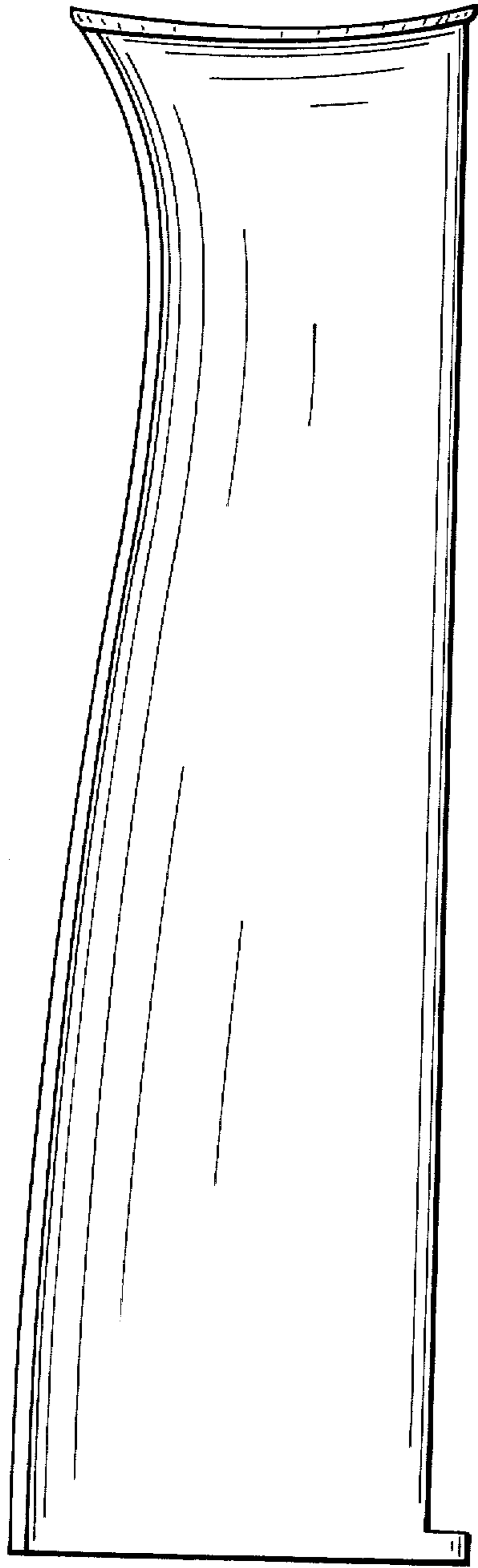

FIG. 13

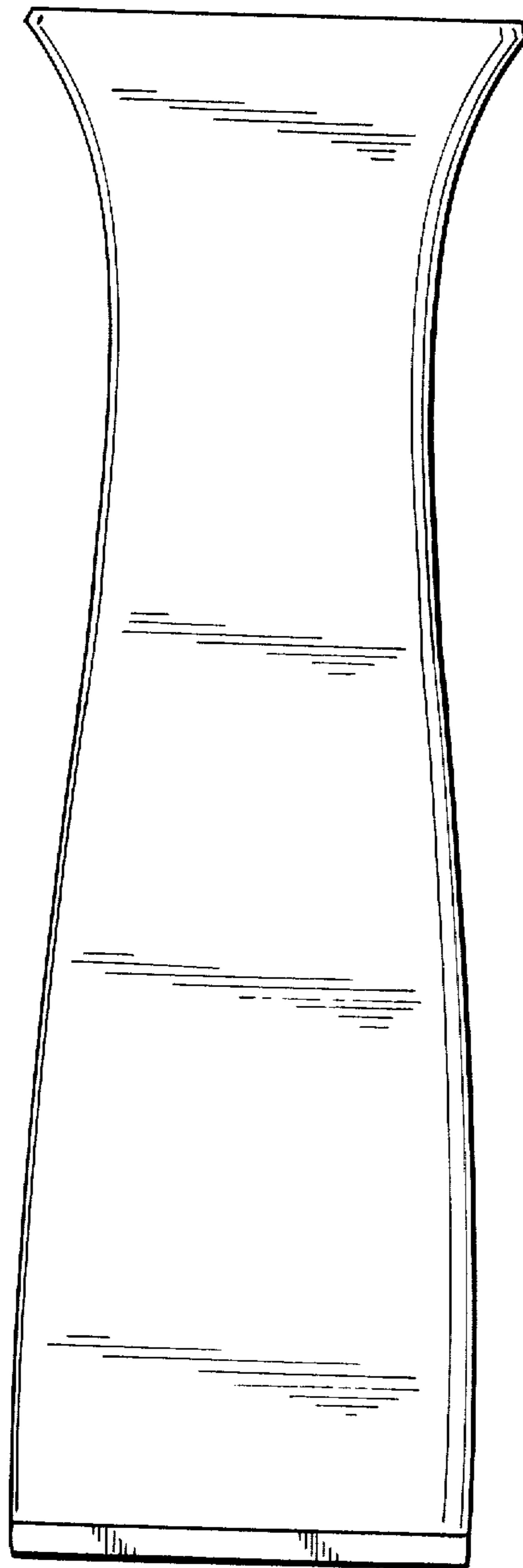

FIG. 14

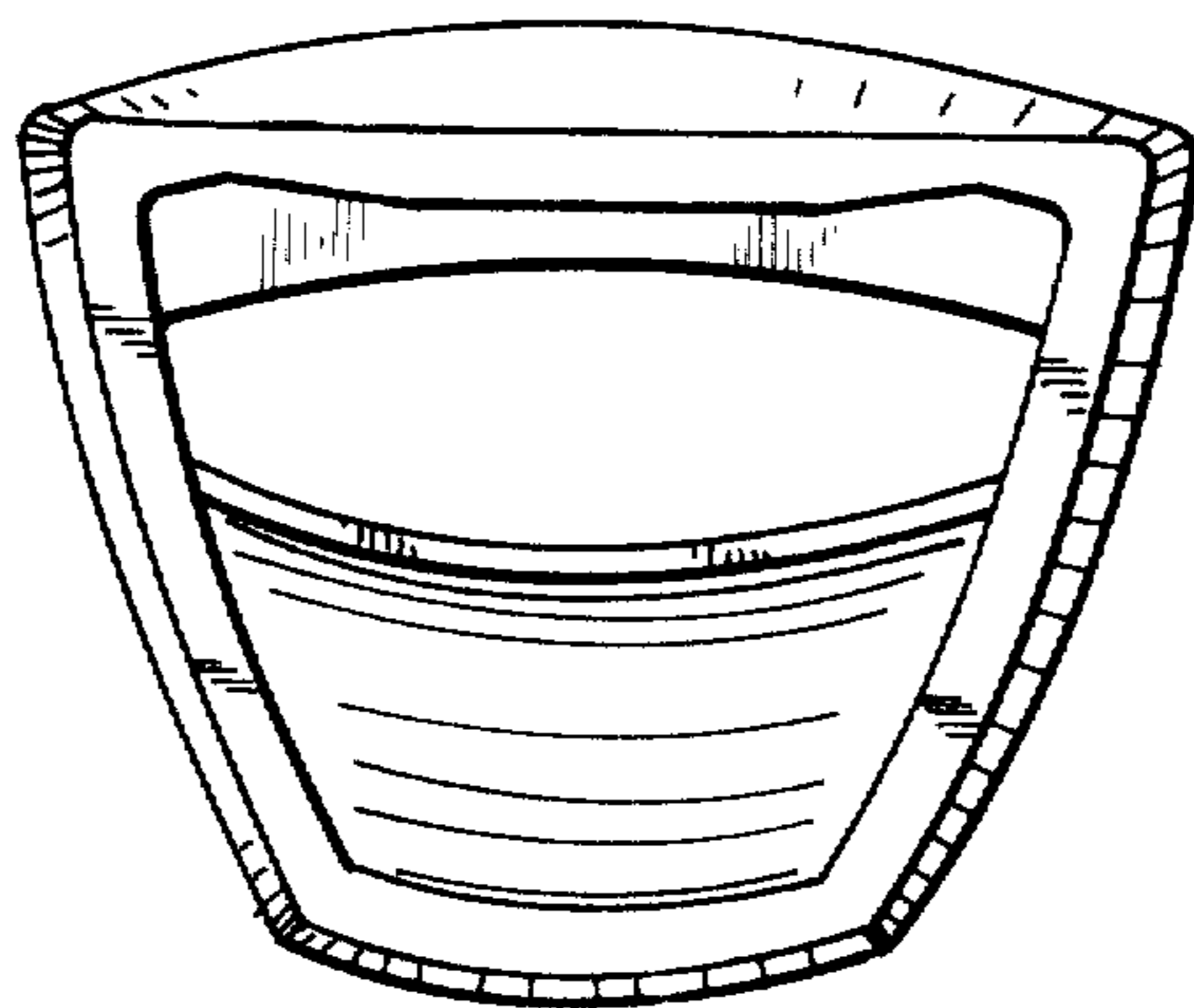

FIG. 15

