

[54] PHOTOGRAPHIC CAMERA

4,299,465 11/1981 Chan 354/145

[75] Inventors: Herbert Schultes, Fürstfeldbruck; Karl-Heinz Rubner, Munich, both of Fed. Rep. of Germany

OTHER PUBLICATIONS

Canon Sure Shot (Flyer), Issue #19-12/79-front cover. Minolta Contact Sheet-F/W 1979.

[73] Assignee: AGFA-Gevaert AG, Leverkusen, Fed. Rep. of Germany

Primary Examiner—Nelson C. Holtje Attorney, Agent, or Firm—Michael J. Striker

[**] Term: 14 Years

[57] CLAIM

[21] Appl. No.: 175,190

The ornamental design for a photographic camera, substantially as shown and described.

[22] Filed: Jul. 31, 1980

DESCRIPTION

[51] Int. Cl. D16-01

[52] U.S. Cl. D16/1

[58] Field of Search D16/1-10, D16/38; 354/288, 202, 152-163, 170-173, 145, 126

FIG. 1 is a left front perspective view of a photographic camera showing our new design in an inoperative condition;

FIG. 2 is a left front perspective view thereof in an operative condition;

FIG. 3 is a front elevational view thereof;

FIG. 4 is a rear elevational view thereof;

FIG. 5 is a top plan view thereof;

FIG. 6 is a bottom plan view thereof;

FIG. 7 is a left side elevational view thereof;

FIG. 8 is a right side elevational view thereof.

[56] References Cited

U.S. PATENT DOCUMENTS

- D. 181,682 12/1957 Stein D16/8
- D. 205,323 7/1966 Claar D16/6
- D. 247,852 5/1978 Fukuda D16/6

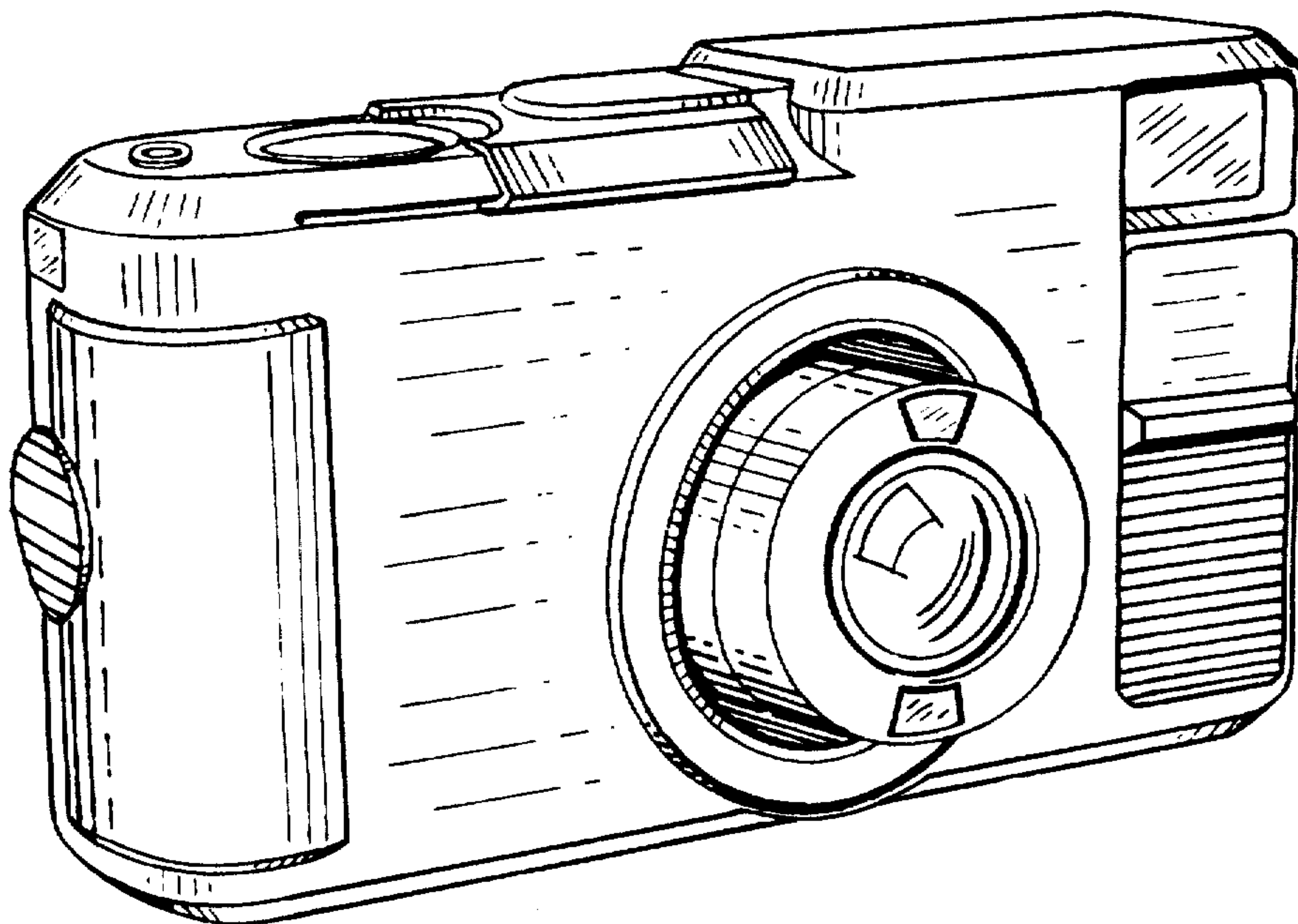

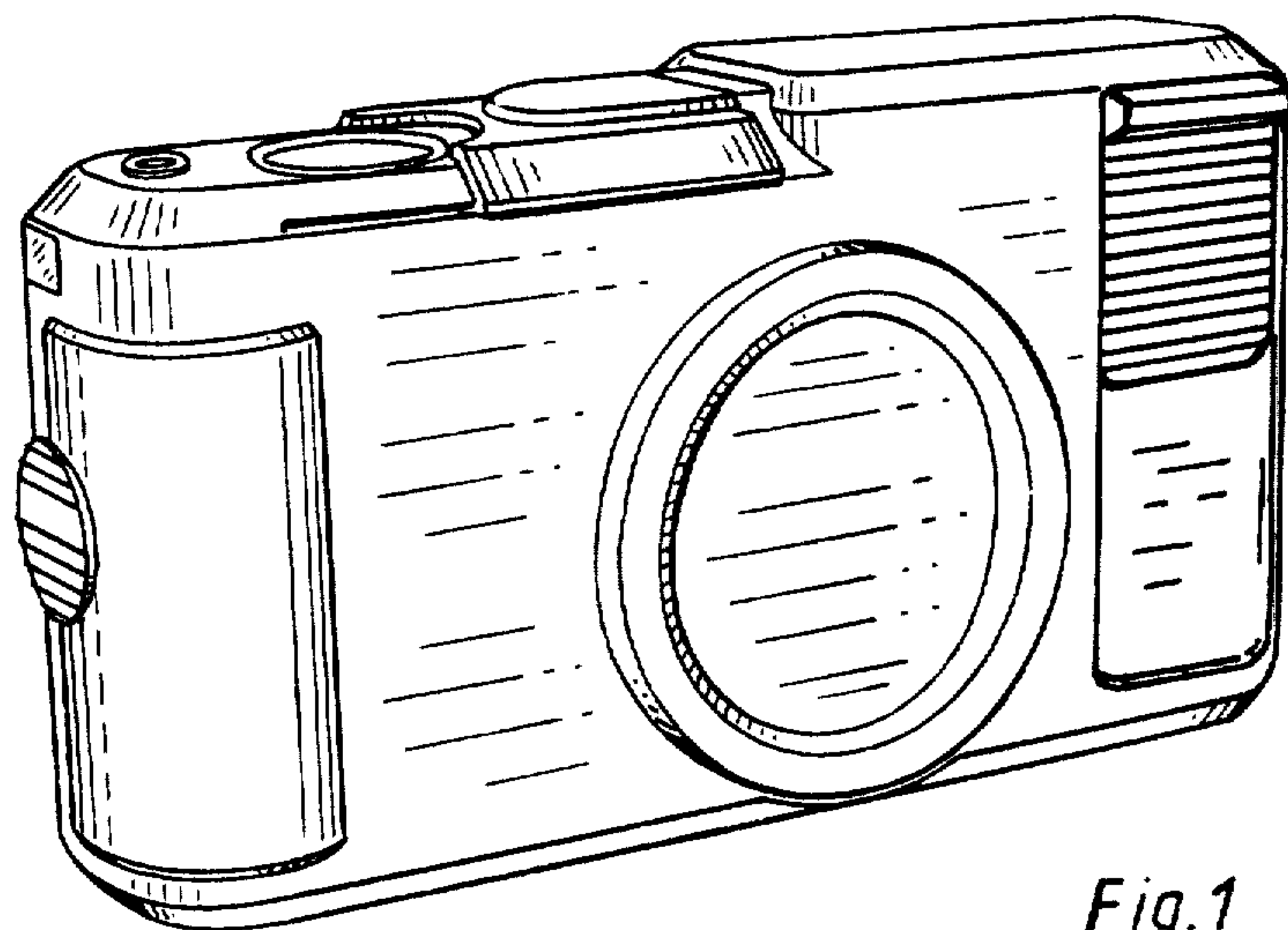

Fig. 1

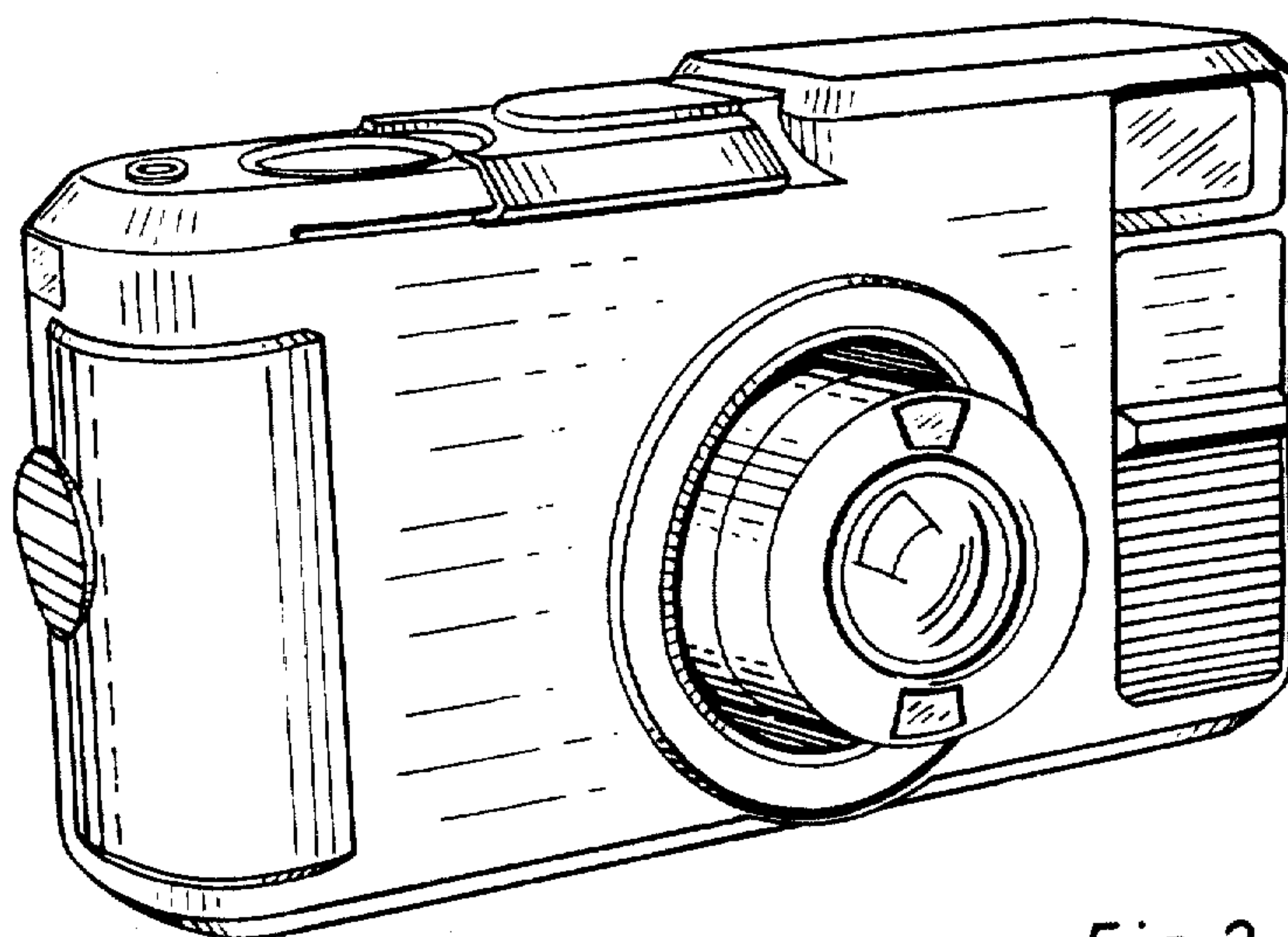

Fig. 2

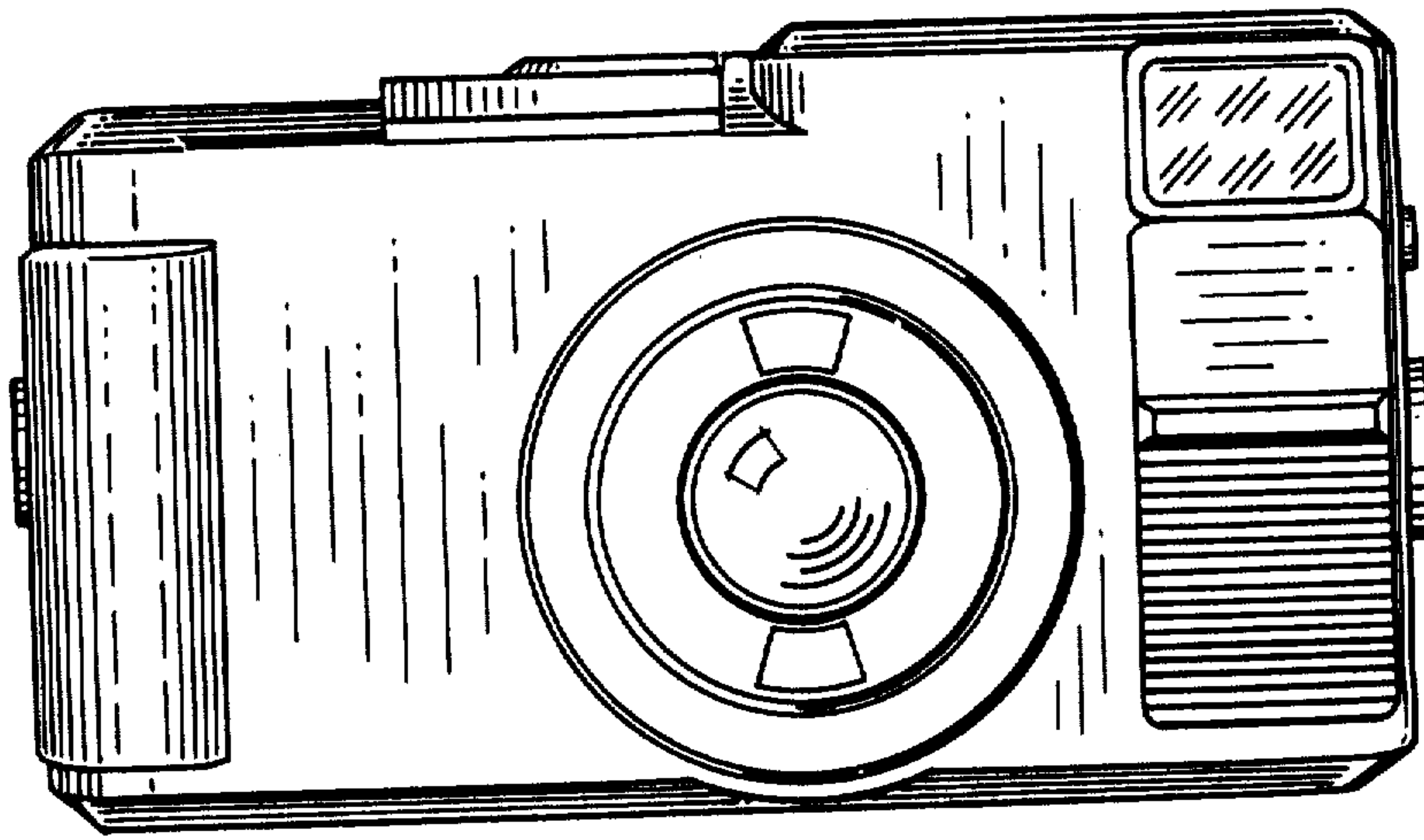

Fig.3

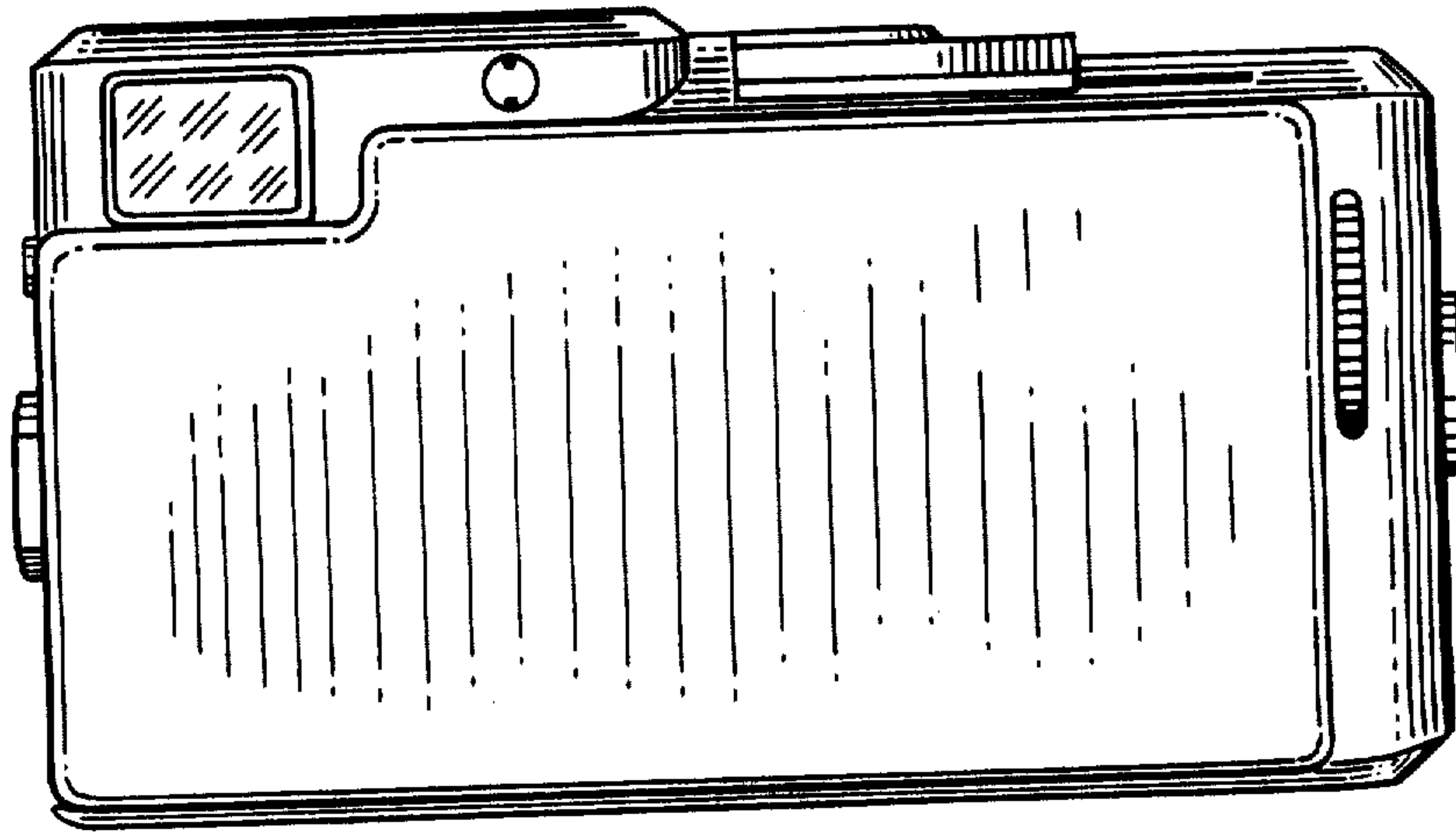

Fig.4

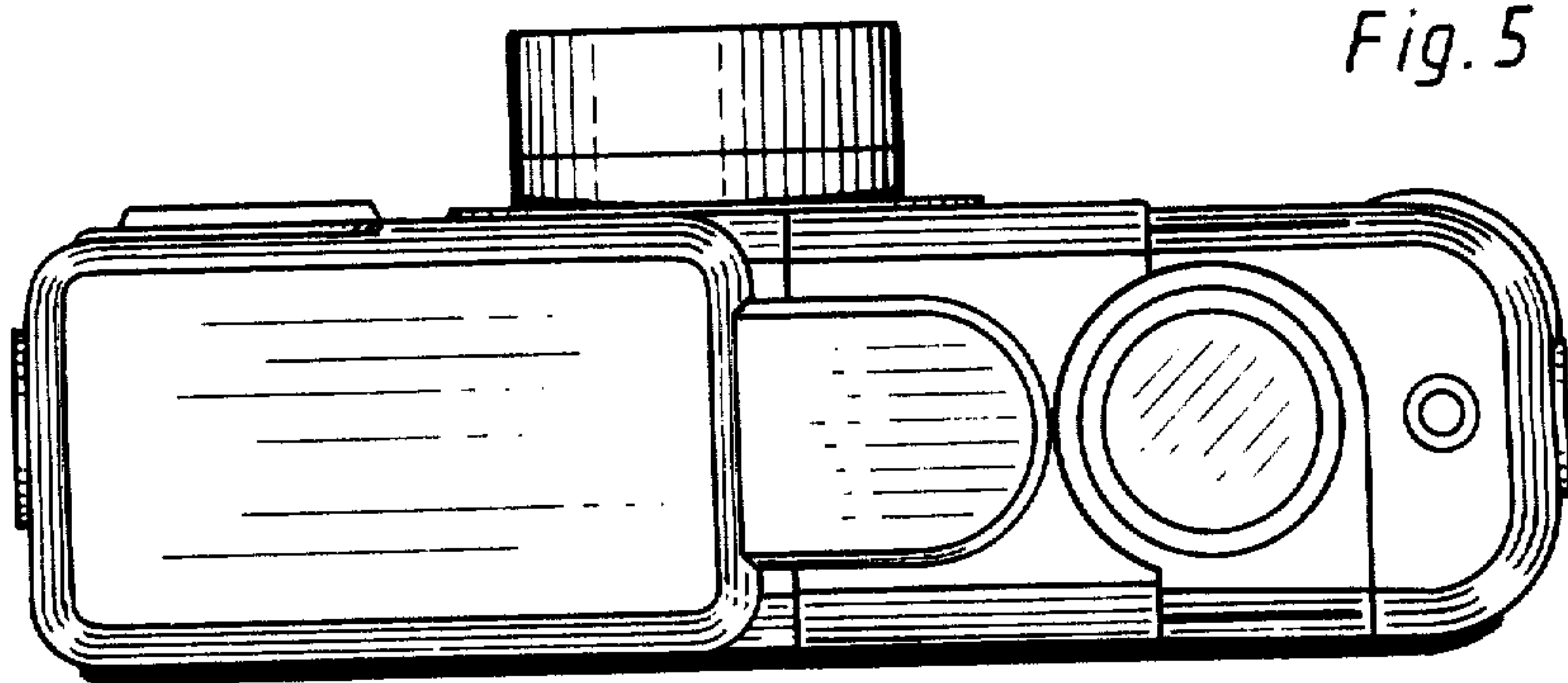

Fig. 5

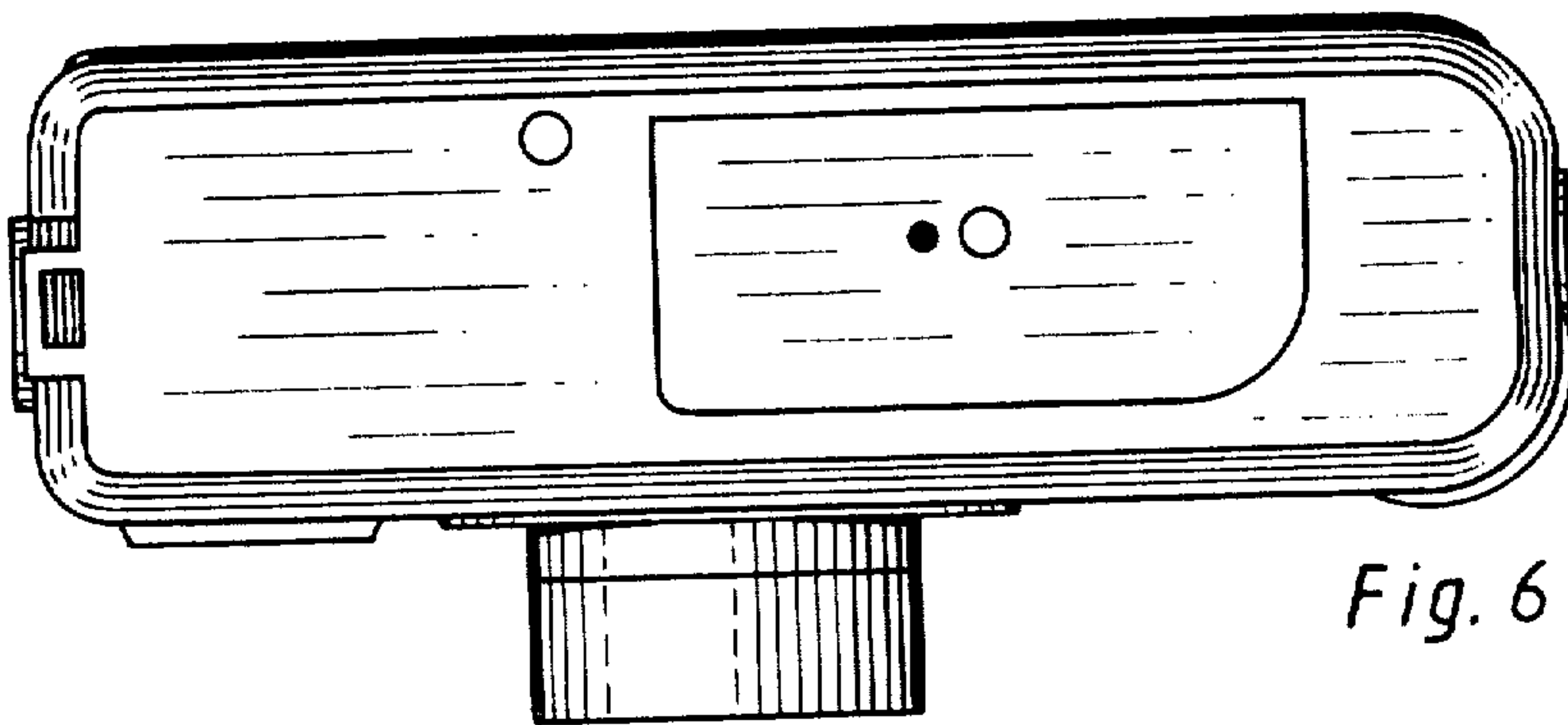

Fig. 6

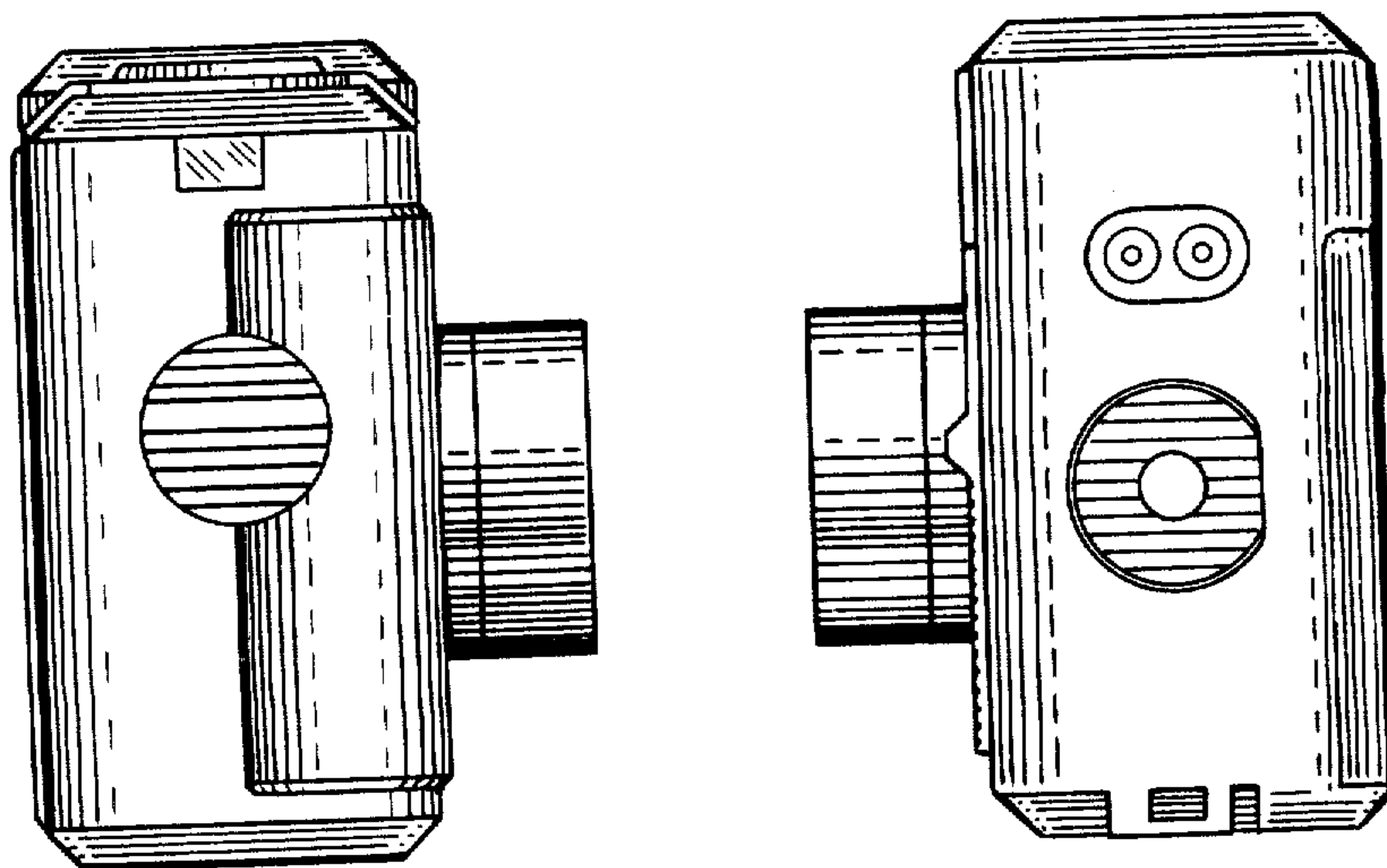

Fig. 7

Fig. 8