

[54] PISTOL HOLSTER

[75] Inventor: Morris C. Fry, Frederick, Md.  
[73] Assignee: Tandy Brands, Inc., Fort Worth, Tex.  
[\*\*] Term: 14 Years  
[21] Appl. No.: 200,212  
[22] Filed: Oct. 24, 1980

[51] Int. Cl. .... D3-02  
[52] U.S. Cl. .... D22/13; D22/14  
[58] Field of Search ..... 224/911, 243; D22/13, D22/14

[56] References Cited  
U.S. PATENT DOCUMENTS

D. 236,891 9/1975 Weissenburger ..... D22/13  
D. 239,532 4/1976 Clark ..... D22/13  
D. 255,141 5/1980 Clark ..... D22/13

D. 259,946 7/1981 Bianchi ..... D22/13  
3,731,858 5/1973 Baker ..... D22/13 X  
4,143,798 3/1979 Perkins ..... 224/911 X

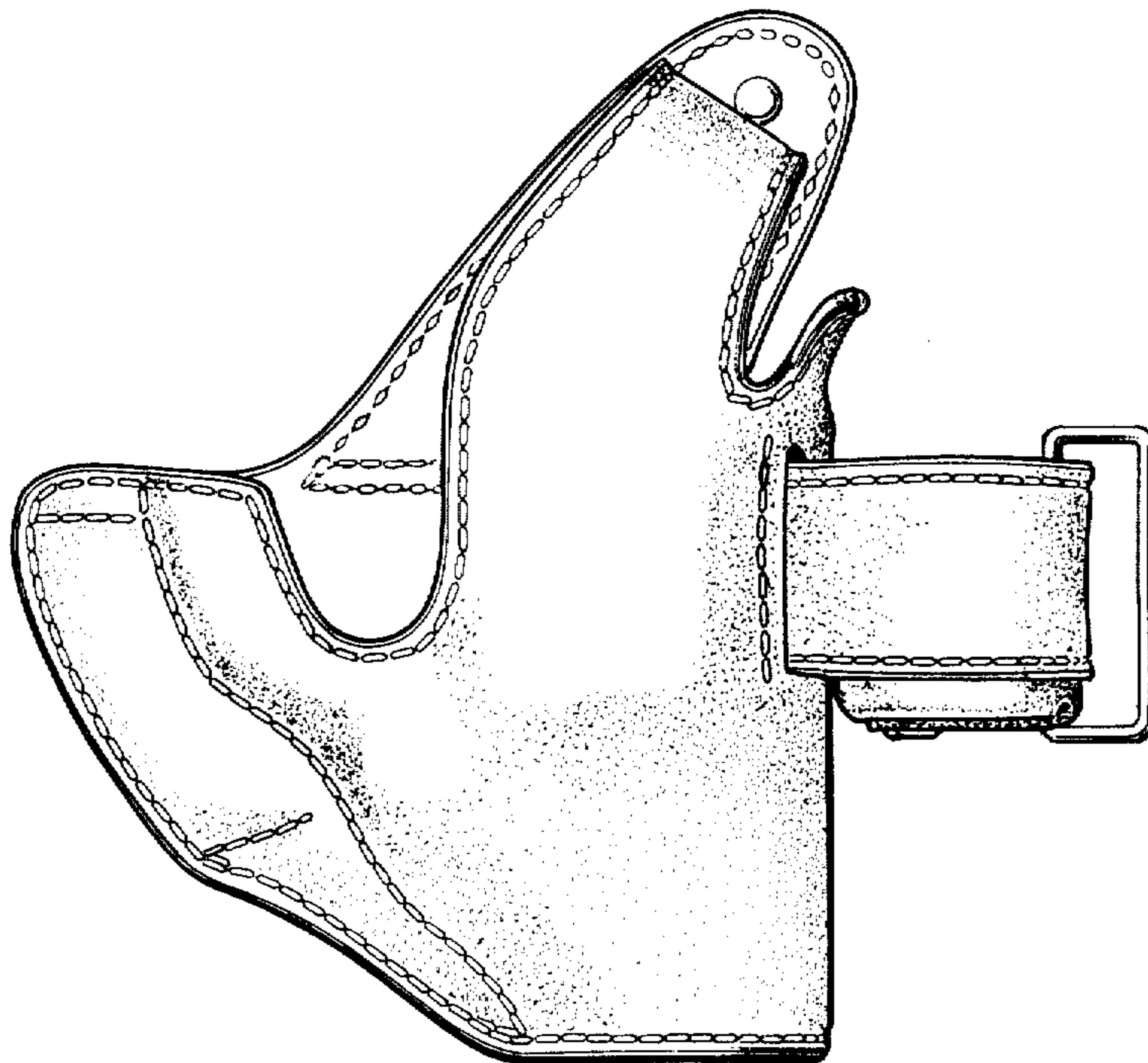
Primary Examiner—A. Hugo Word  
Attorney, Agent, or Firm—Robert A. Felsman

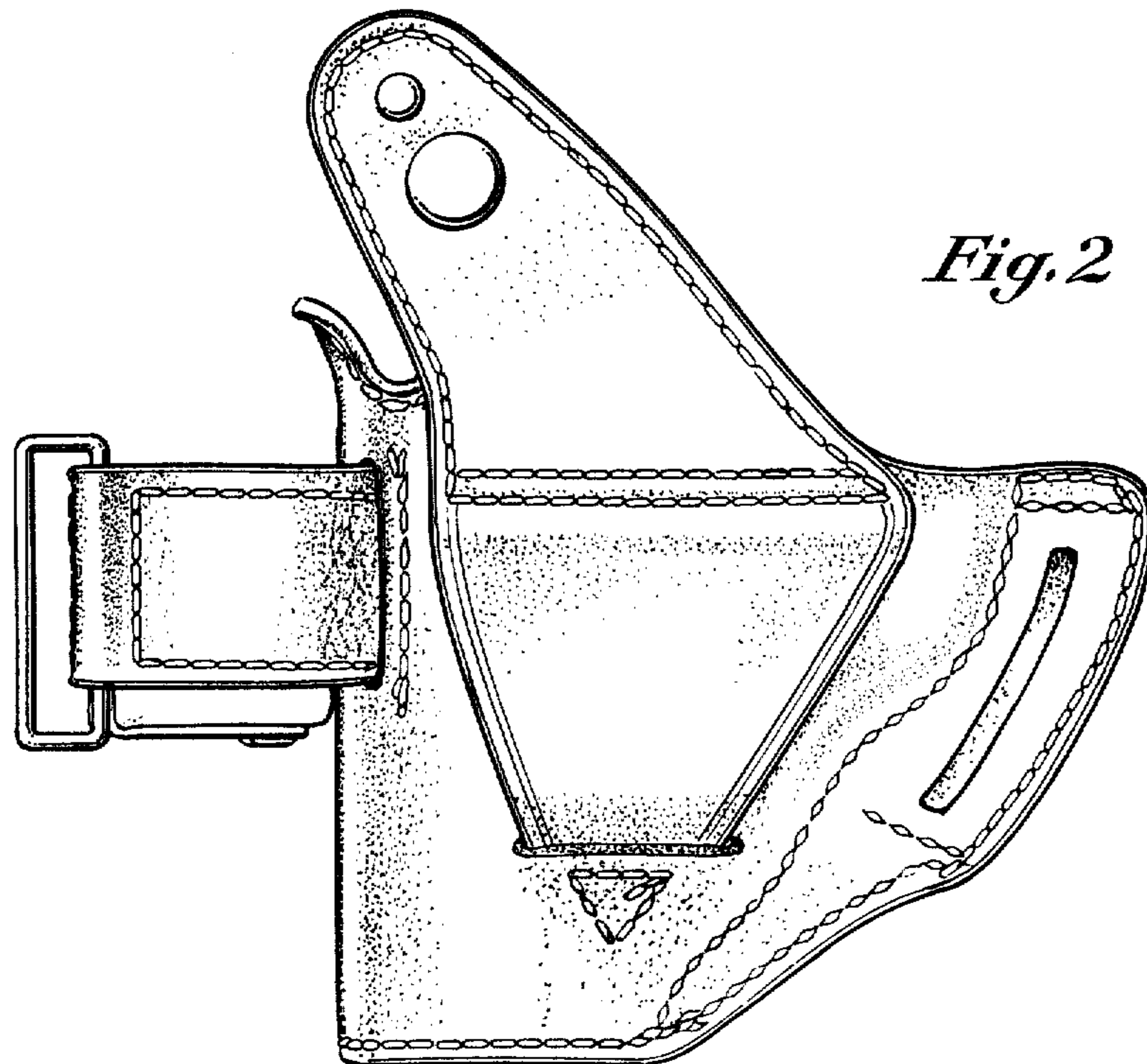
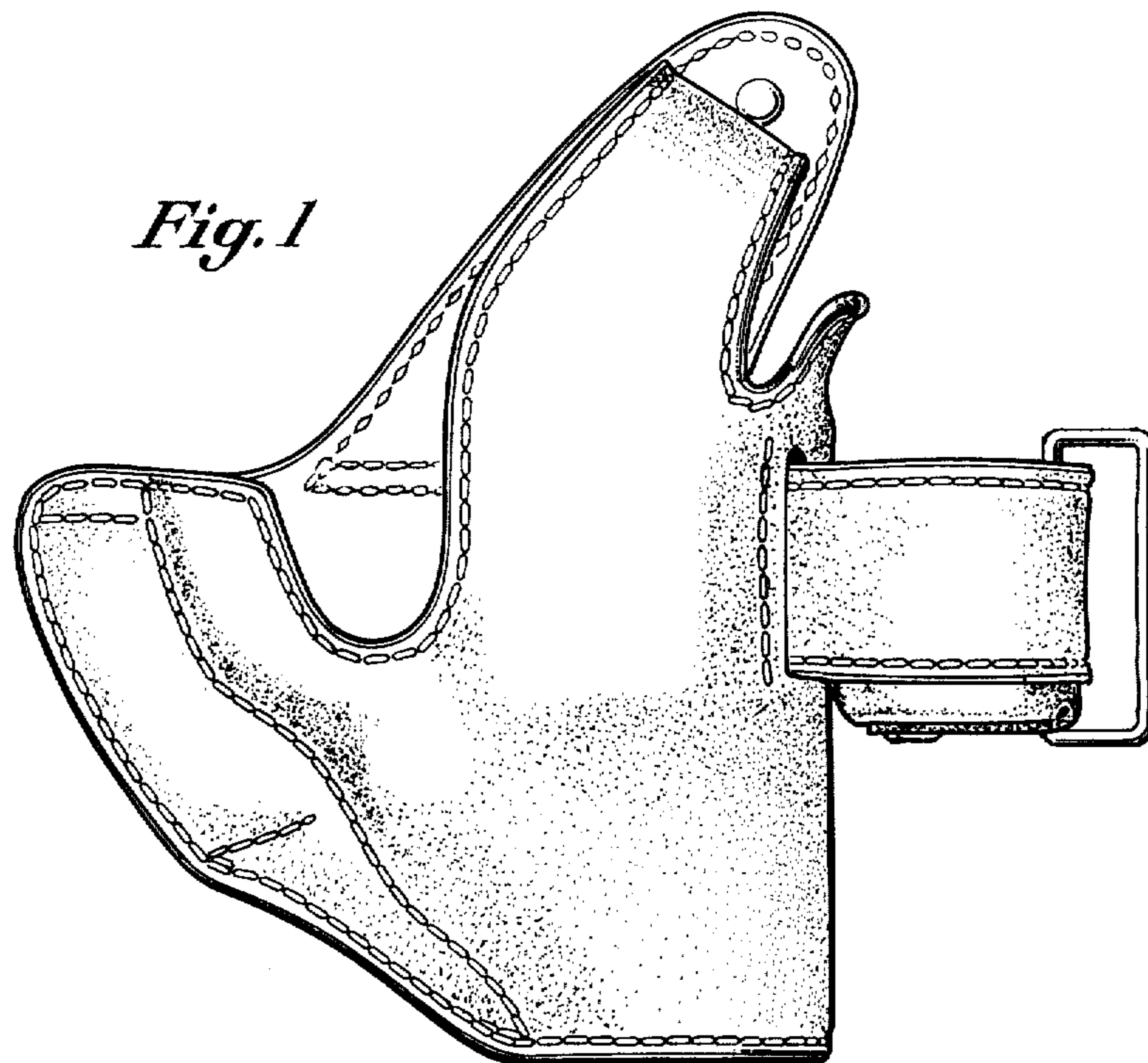
[57] CLAIM

The ornamental design for the pistol holster, as shown in the drawings.

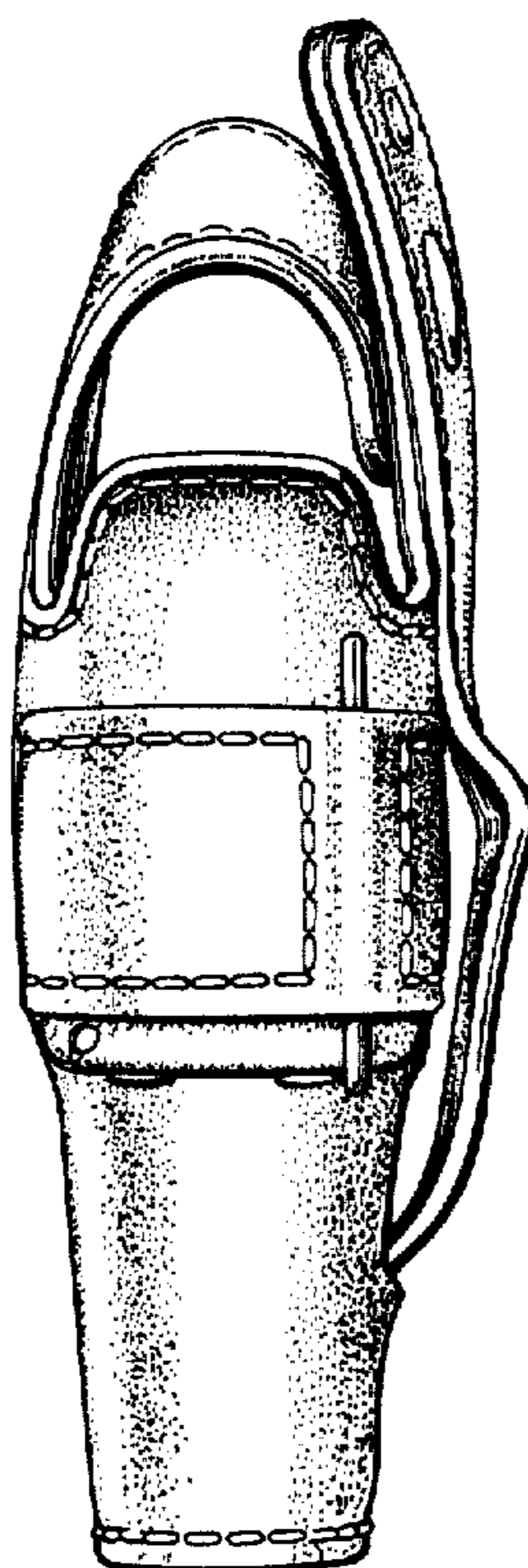
DESCRIPTION

FIG. 1 is a front view of the holster that embodies my new and ornamental design.  
FIG. 2 is a rear view of the pistol holster.  
FIG. 3 is a side view of pistol holster as seen from the right side of FIG. 1.  
FIG. 4 is a side view of the pistol holster as seen from the left side of FIG. 1.  
FIG. 5 is a top view of the pistol holster.  
FIG. 6 is a bottom view of the pistol holster.

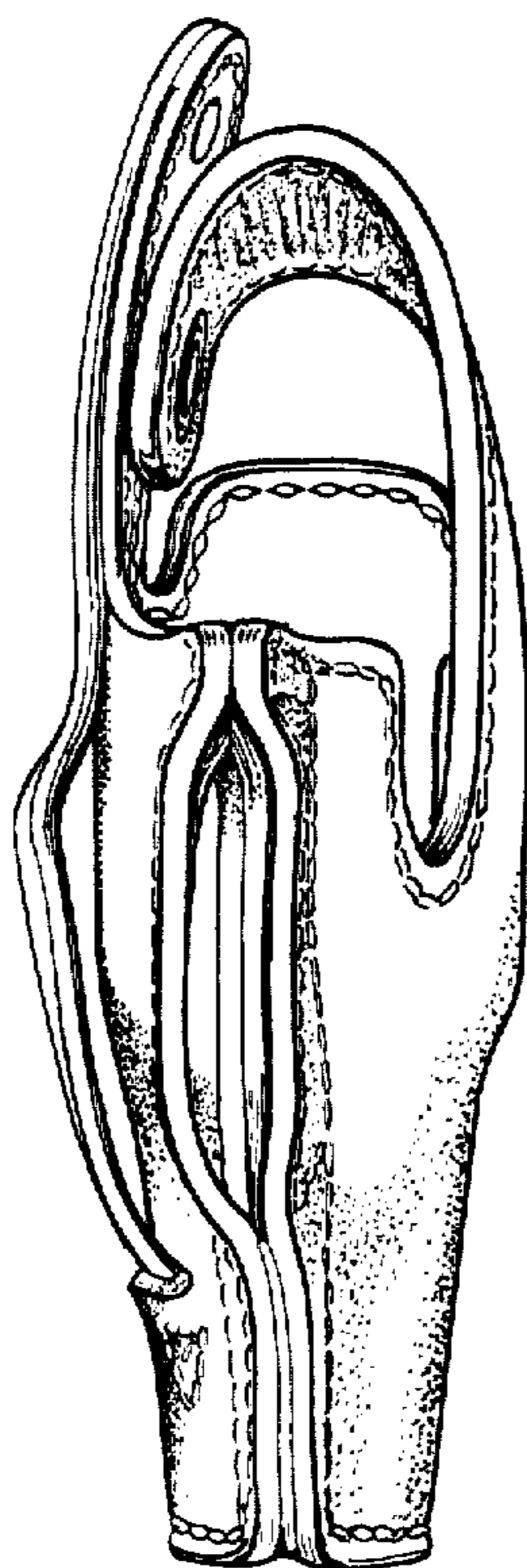




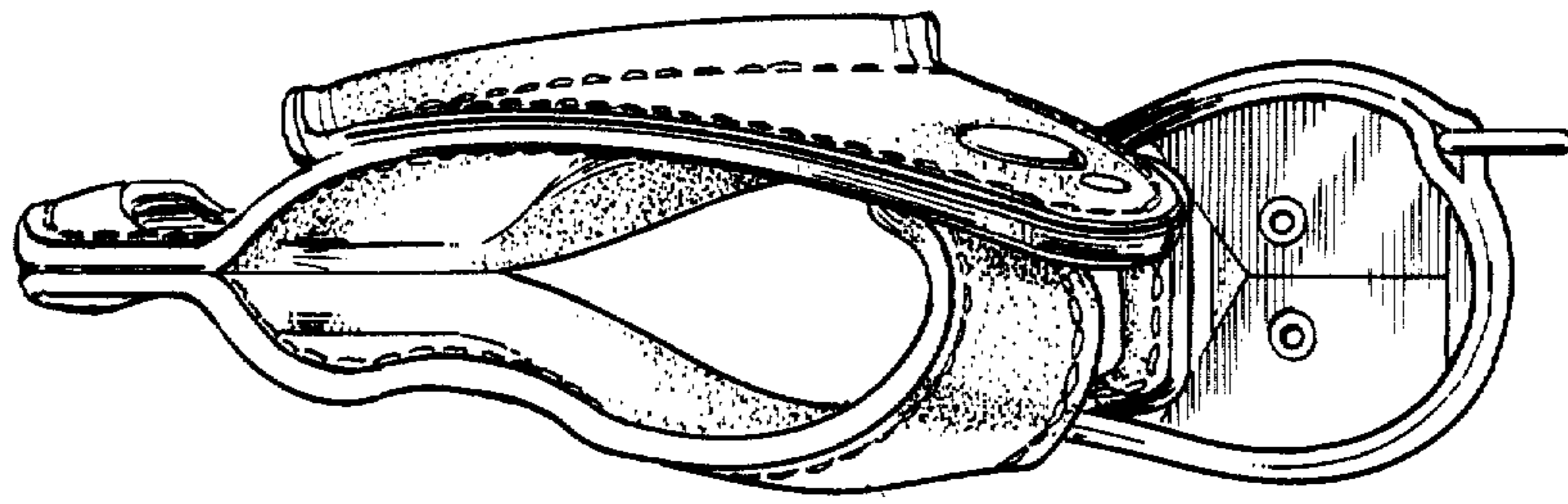
*Fig. 3*



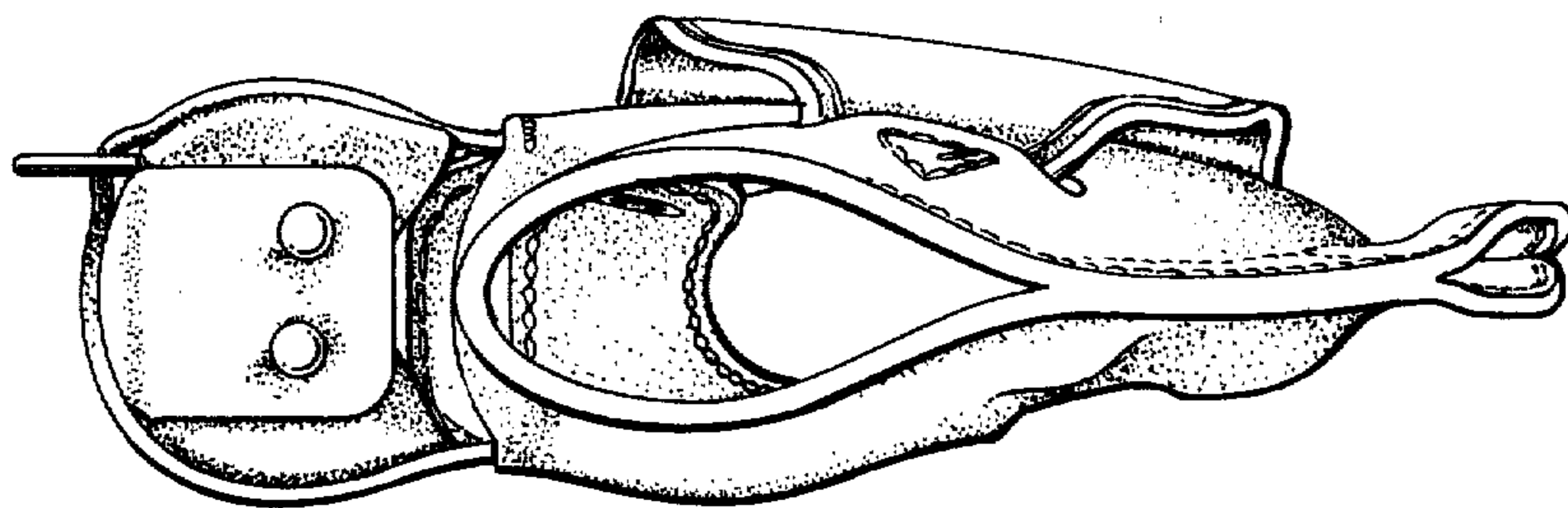
*Fig. 4*







*Fig. 5*



*Fig. 6*