

[54] ELECTRONIC COPYING MACHINE

[75] Inventors: Shigeki Yasutani, Kashiwa; Kunio Hara, Chiba, both of Japan

[73] Assignee: Tokyo Shibaura Denki Kabushiki Kaisha, Japan

[**] Term: 14 Years

[21] Appl. No.: 140,588

[22] Filed: Apr. 15, 1980

[51] Int. Cl. D16-03

[52] U.S. Cl. D16/31

[58] Field of Search D16/27, 29, 30, 31; 355/3, 8, 11, 50, 51

[56] References Cited

U.S. PATENT DOCUMENTS

Re. 27,700	7/1973	Suzuki et al.	355/8 X
Re. 29,632	5/1978	Tanaka	355/8
D. 251,912	5/1979	Nakade	D16/31
3,397,627	8/1968	Bruning	355/11 X
3,597,074	8/1971	Murgas et al.	355/8 X

3,689,146	9/1972	Ito	355/8
3,813,157	5/1974	Fantozzi	355/51 X
3,861,796	1/1975	Tanaka	355/8
4,136,941	1/1979	Sawaoka	355/8
4,268,164	5/1981	Yajima	355/51 X

Primary Examiner—Nelson C. Holtje
Attorney, Agent, or Firm—Finnegan, Henderson, Farabow, Garrett & Dunner

[57] CLAIM

The ornamental design for an electronic copying machine, substantially as shown and described.

DESCRIPTION

FIG. 1 is a perspective view of an electronic copying machine showing our new design; FIG. 2 shows a perspective view of FIG. 1 thereof with a cover opened; FIG. 3 is a front elevational view thereof; FIG. 4 is a rear elevational view thereof; FIG. 5 is a top plan view thereof; FIG. 6 is a bottom plan view thereof; FIG. 7 is a left side elevational view thereof; and FIG. 8 is a right side elevational view thereof.

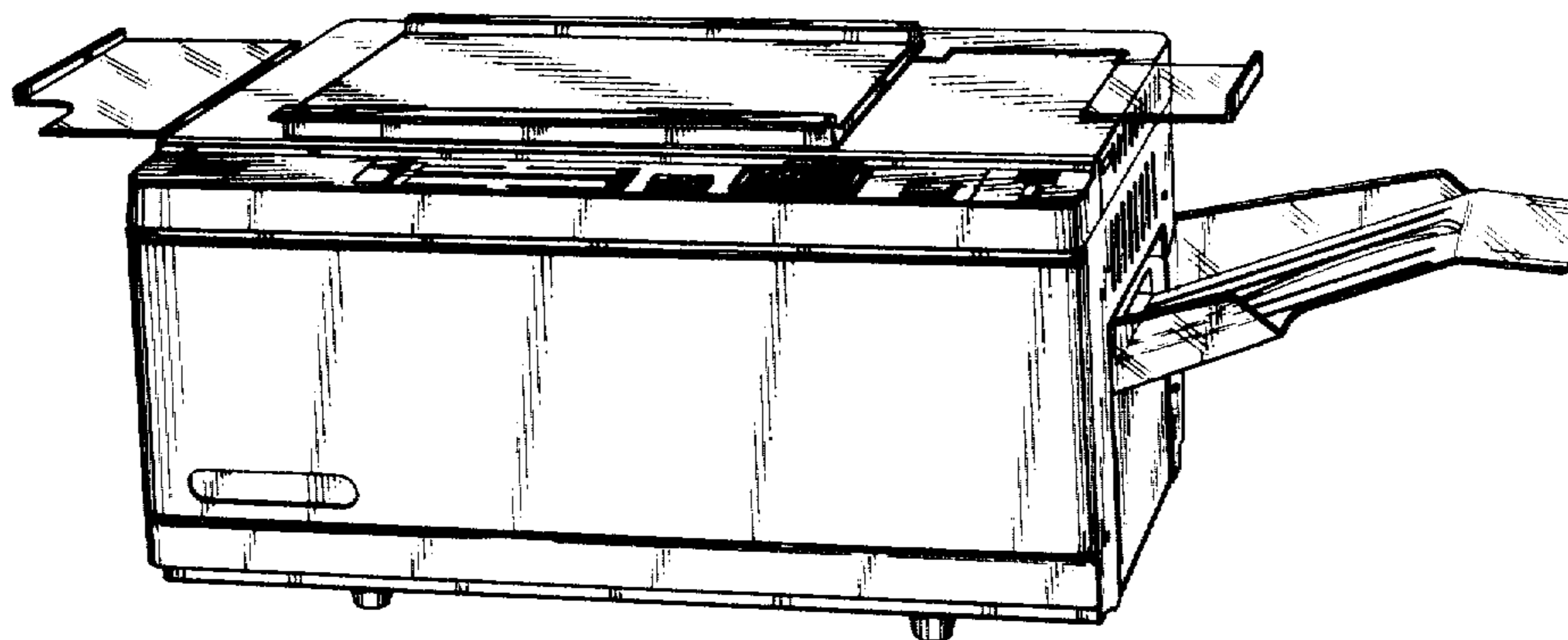

FIG. 1

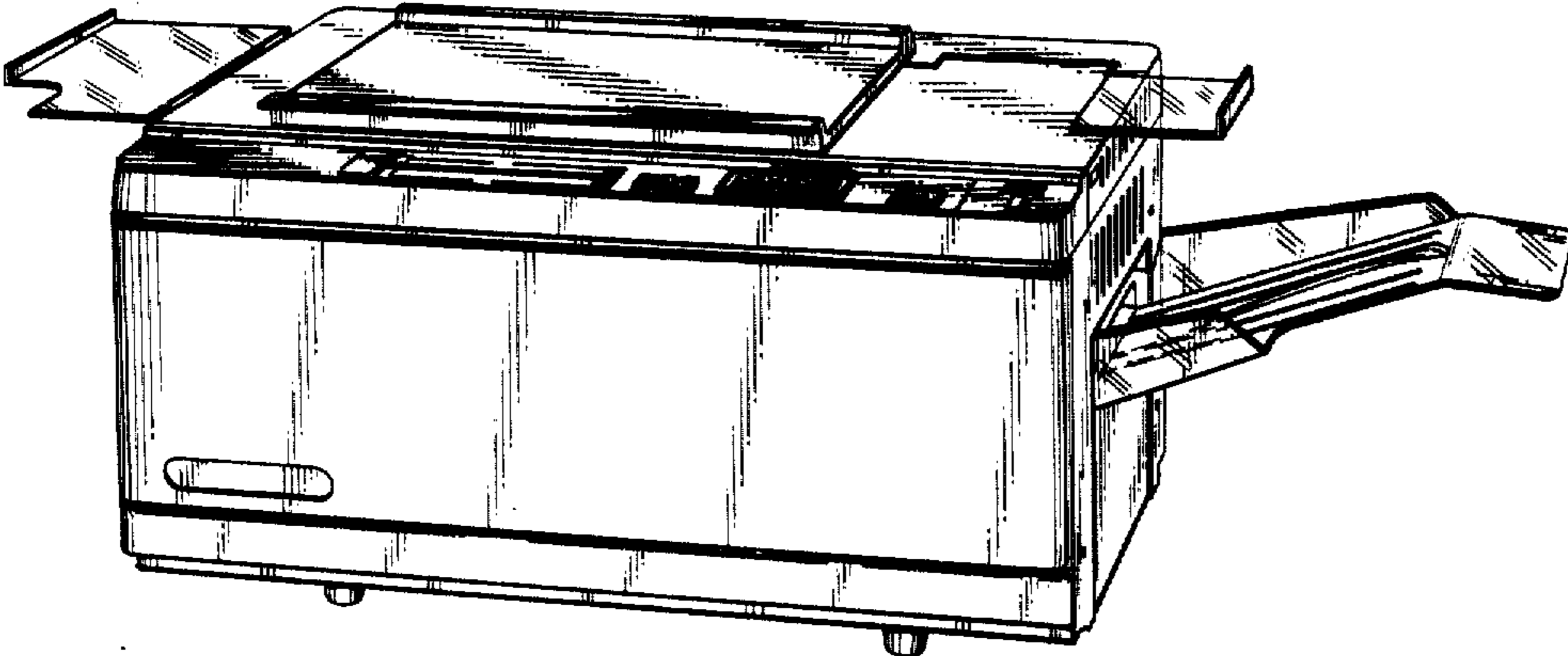

FIG. 2

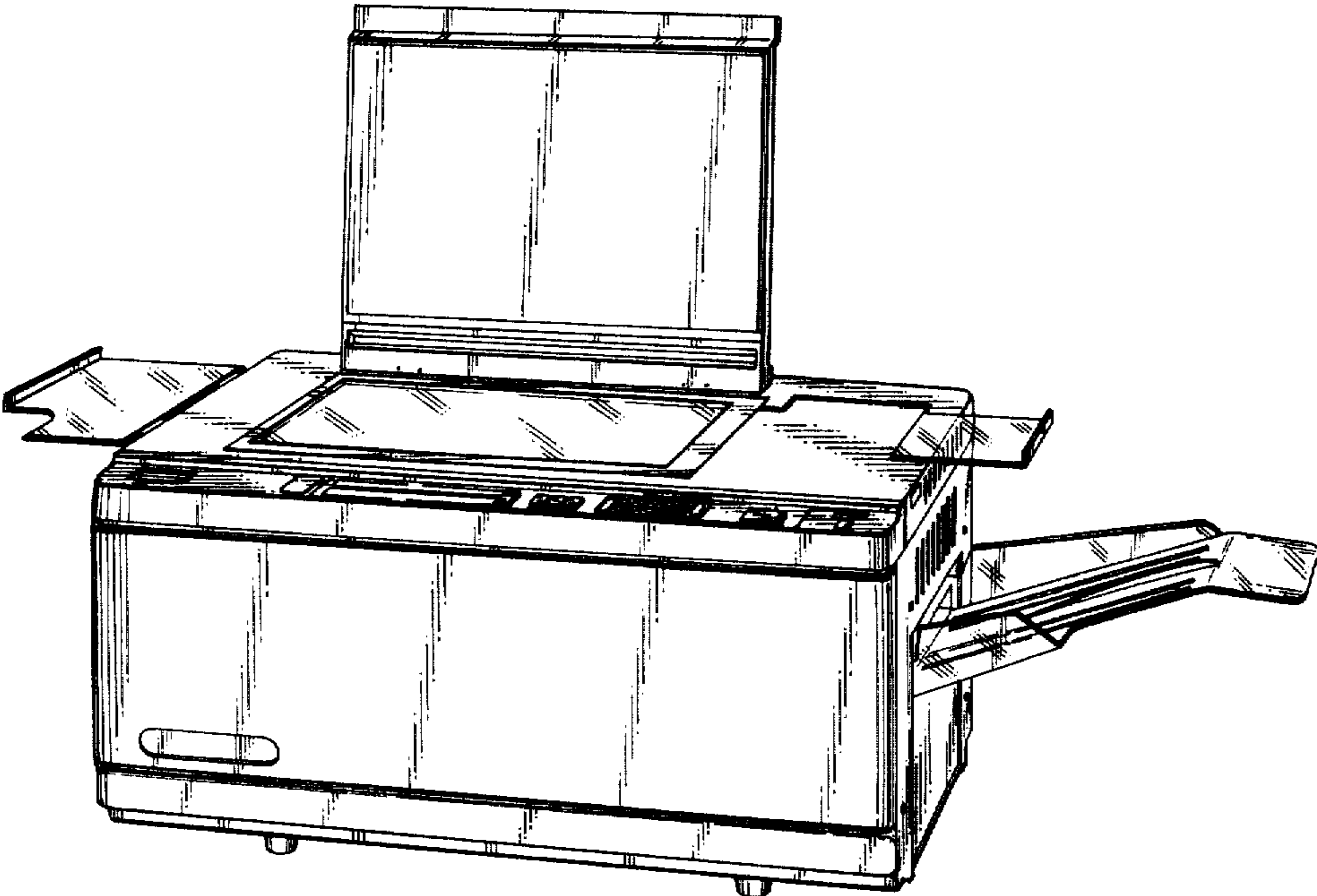

FIG. 3

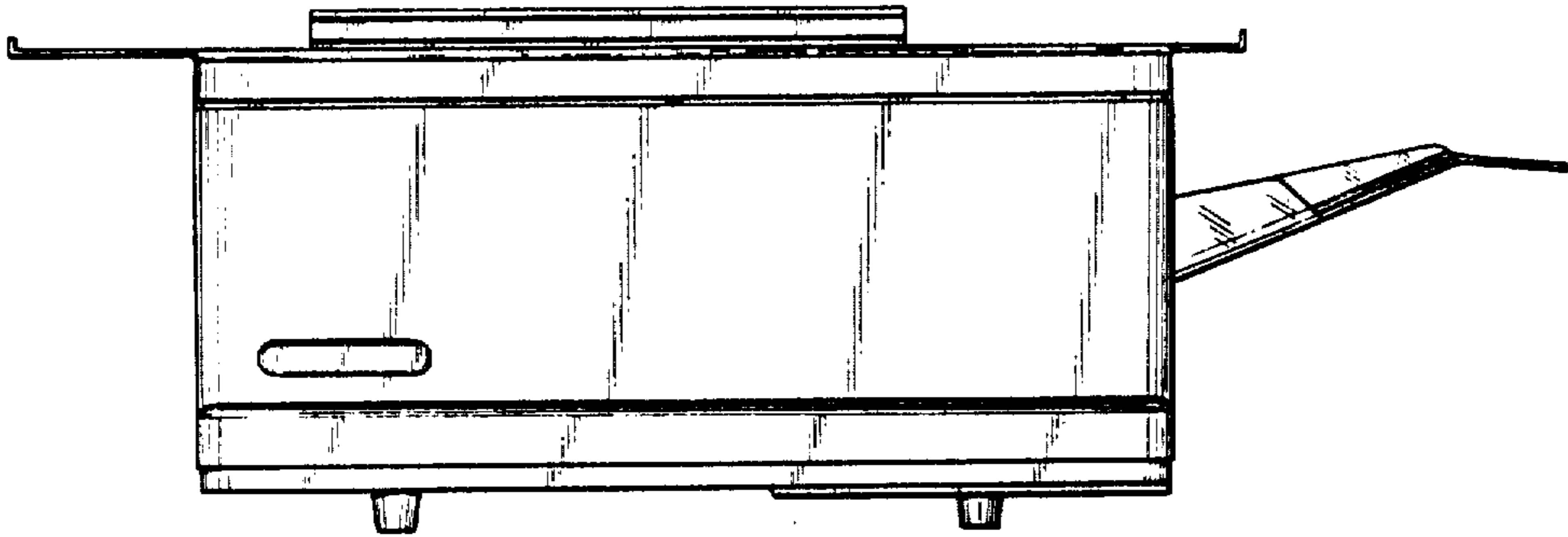

FIG. 4

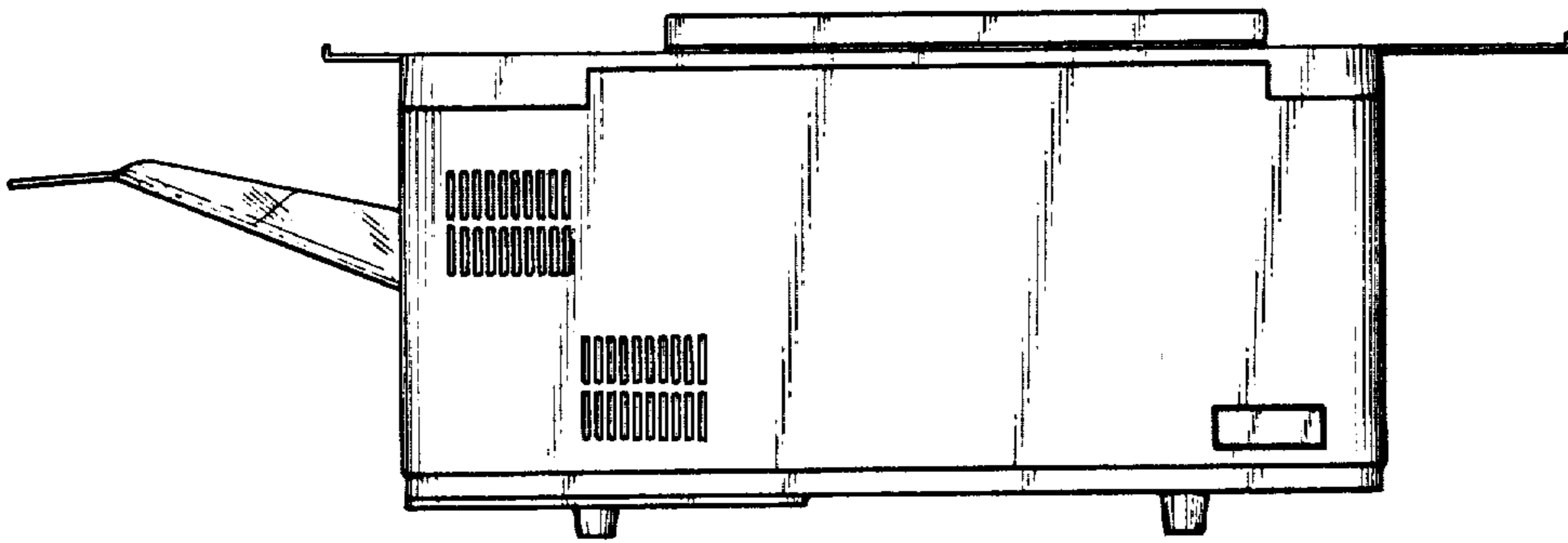

FIG. 5

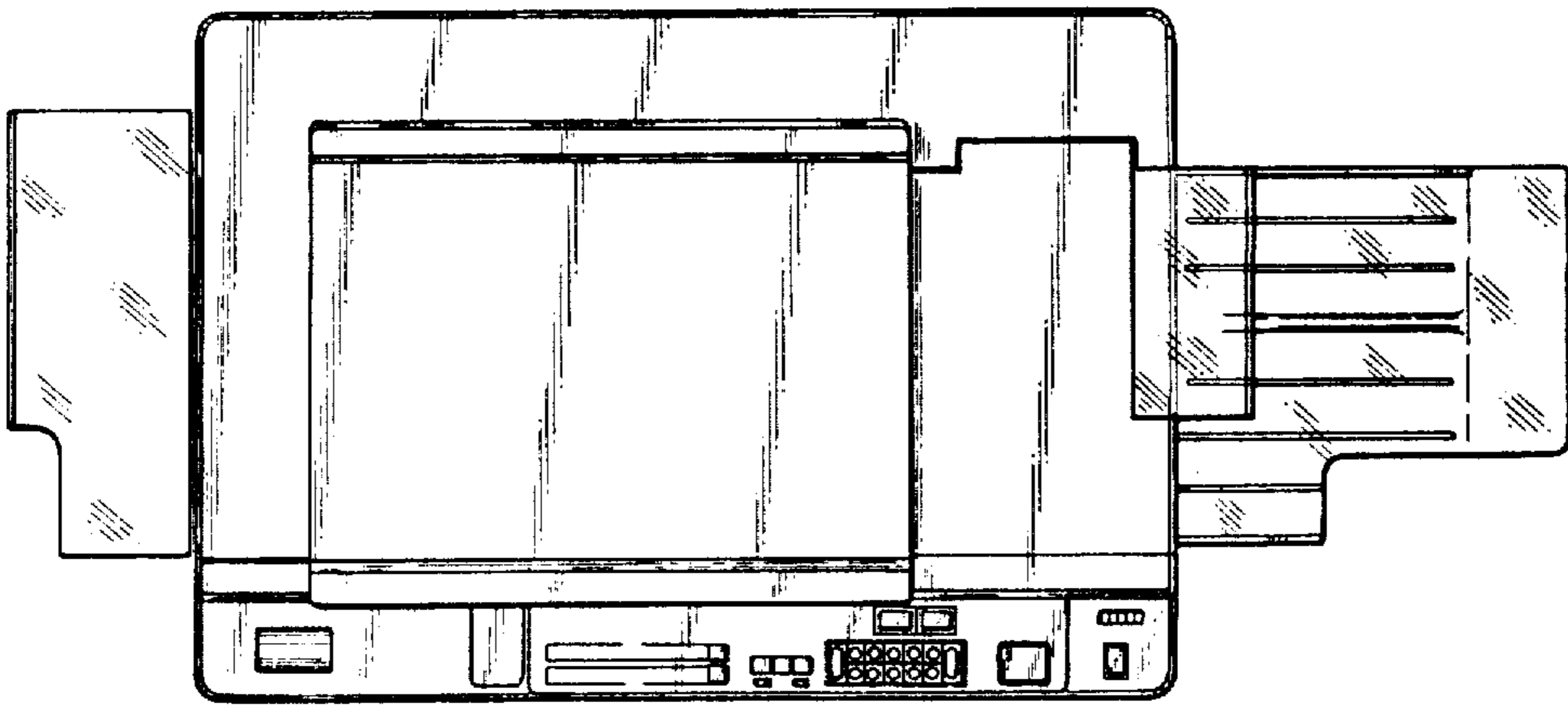

FIG. 6

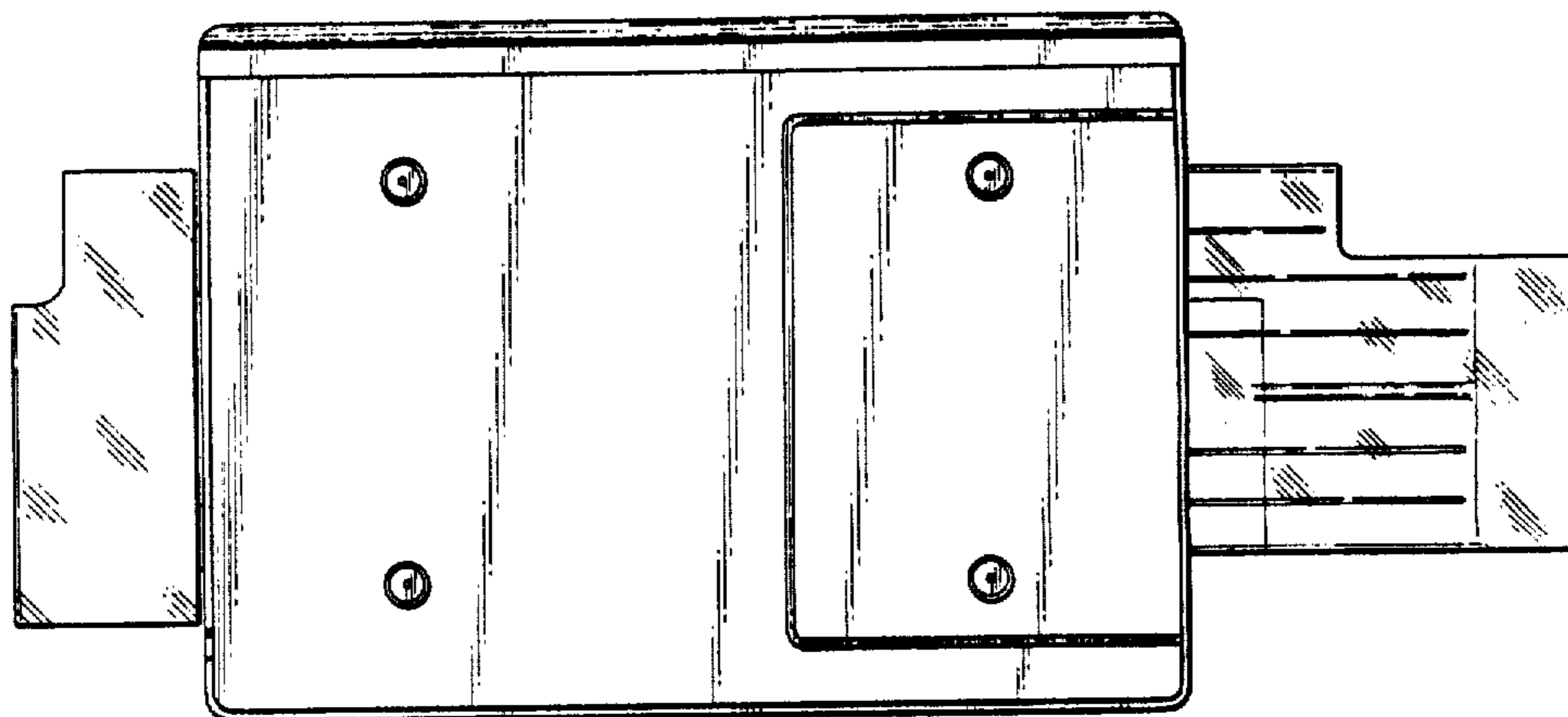

FIG. 7

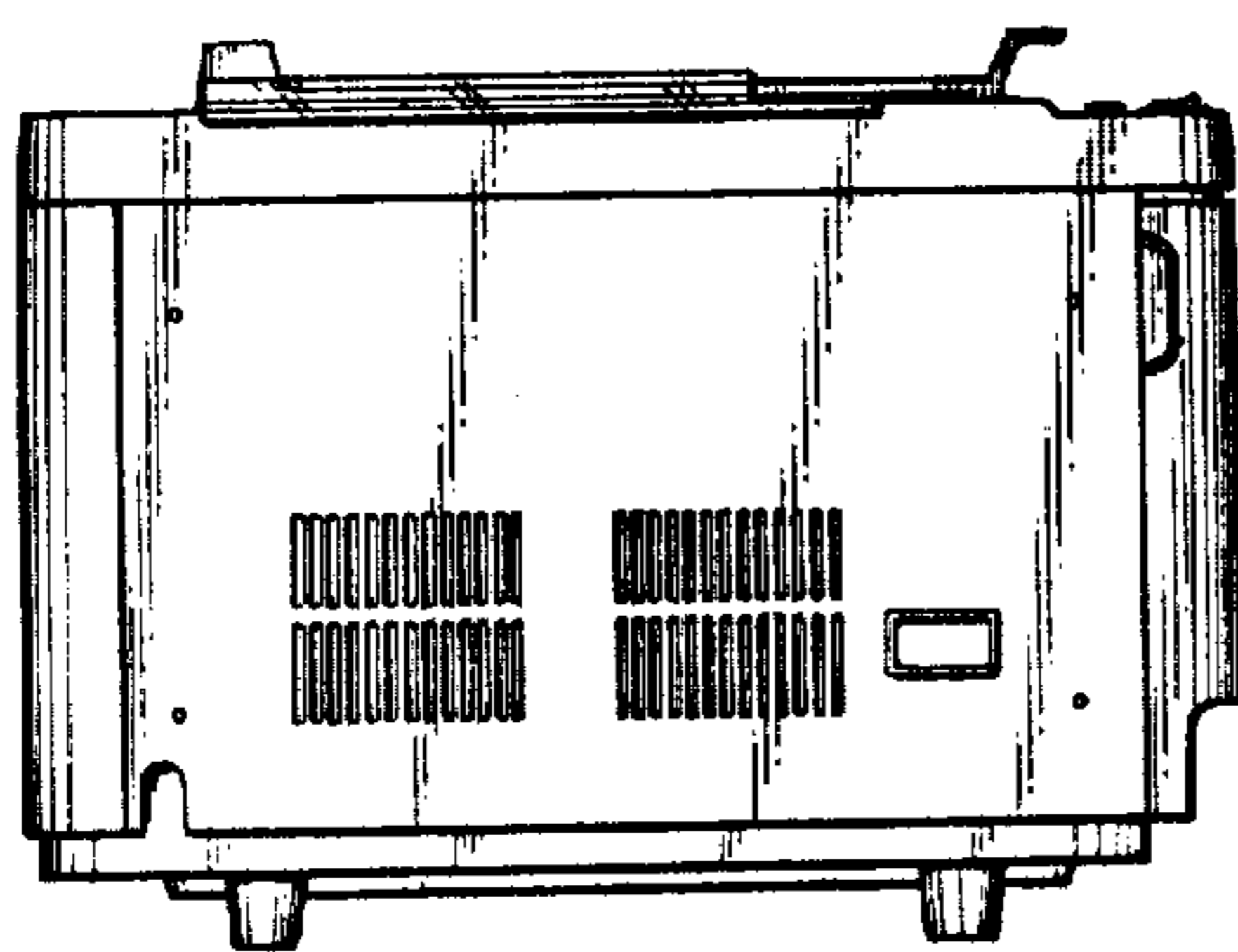

FIG. 8

