

[54] MARKER LAMP LENS

[75] Inventors: Karel Urbanek, Weston; Arthur F. Bleiweiss, Toronto, both of Canada

[73] Assignee: Dominion Auto Accessories Limited, Toronto, Canada

[**] Term: 14 Years

[21] Appl. No.: 25,775

[22] Filed: Apr. 2, 1979

[51] Int. Cl. D26-06

[52] U.S. Cl. D26/122

[58] Field of Search D10/109, 111, 114; D26/28, 36, 120, 123, 124, 122; 362/61, 297, 300, 307, 311, 326, 329, 330, 334, 335-339

[56] References Cited

U.S. PATENT DOCUMENTS

D. 191,130	8/1961	Mappes	D26/28
D. 191,131	8/1961	Mappes	D26/28
D. 246,131	10/1977	Schifrin	D26/28
3,107,061	10/1963	Morgan	362/226
3,184,590	5/1965	Nagel	362/337

3,235,721 2/1966 Dickson 362/311

Primary Examiner—Peter M. Caun
Attorney, Agent, or Firm—Barnes, Kisselle, Raisch & Choate

[57] CLAIM

The ornamental design for a marker lamp lens, as shown and described.

DESCRIPTION

FIG. 1 is a plan view of a marker lamp lens embodying our novel design.

FIG. 2 is an elevational view of the same.

FIG. 3 is an end view of the same.

FIG. 4 is a plan view of a modified form of marker lamp lens.

FIG. 5 is a side elevational view of the same.

FIG. 6 is an end view of the same.

FIG. 7 is a horizontal sectional view.

FIG. 8 is a sectional view taken along the line 8—8 in FIG. 7.

FIG. 9 is a sectional view taken along the line 9—9 in FIG. 8.

FIG. 10 is a sectional view taken along the line 10—10 in FIG. 8.

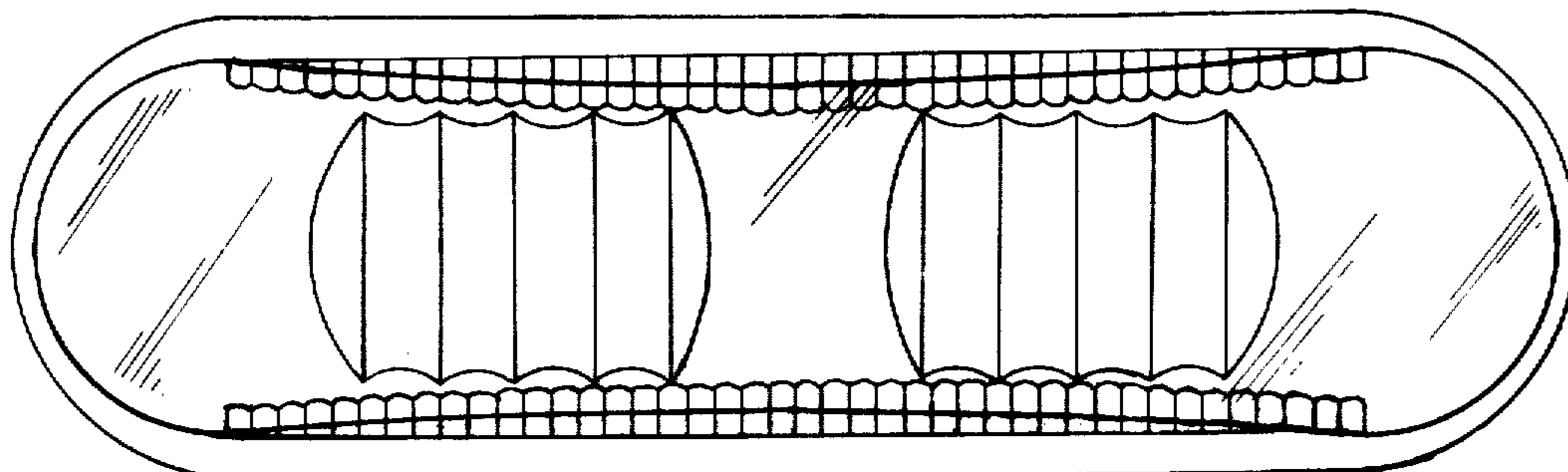

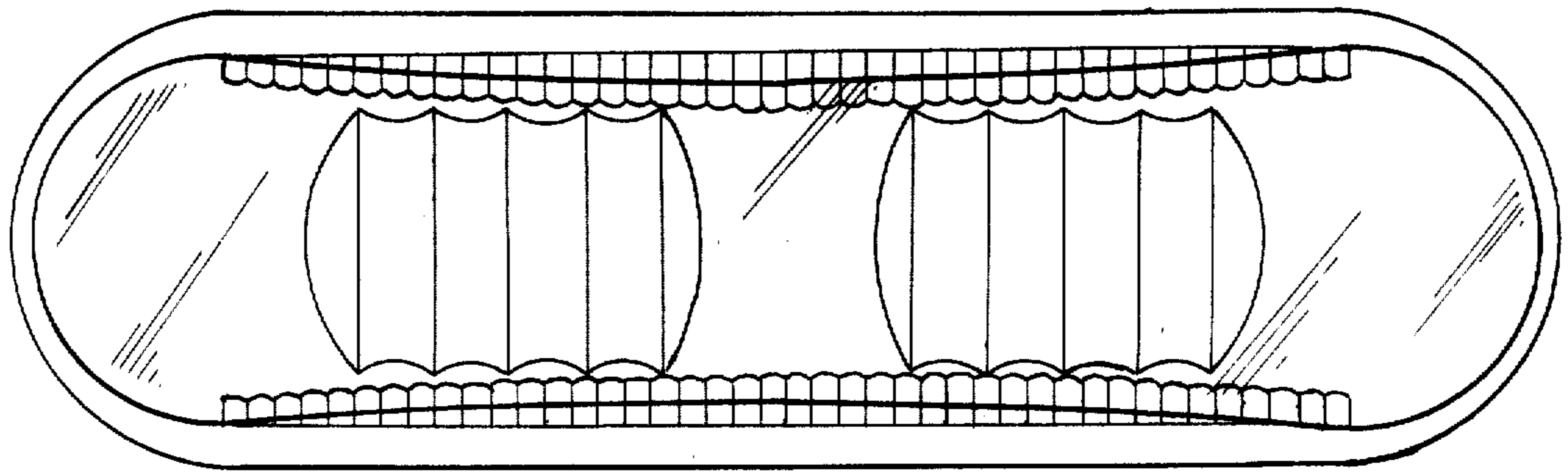

FIG. 1

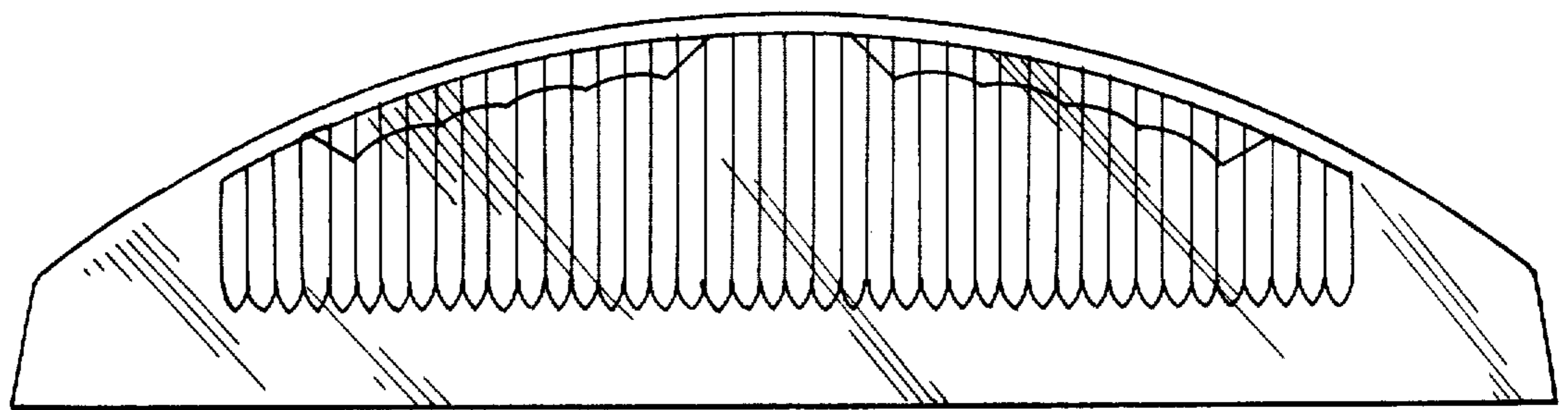

FIG. 2

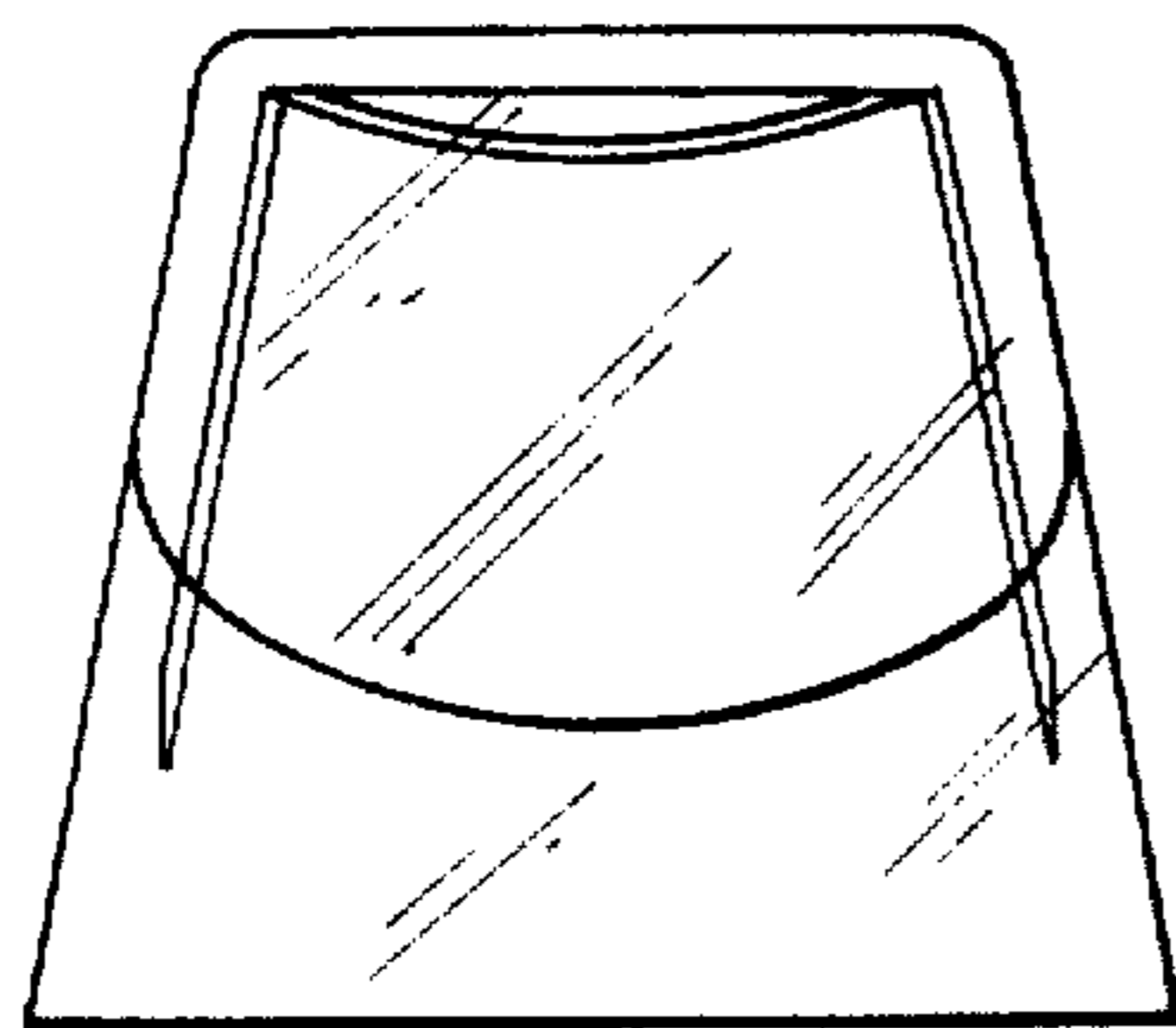

FIG. 3

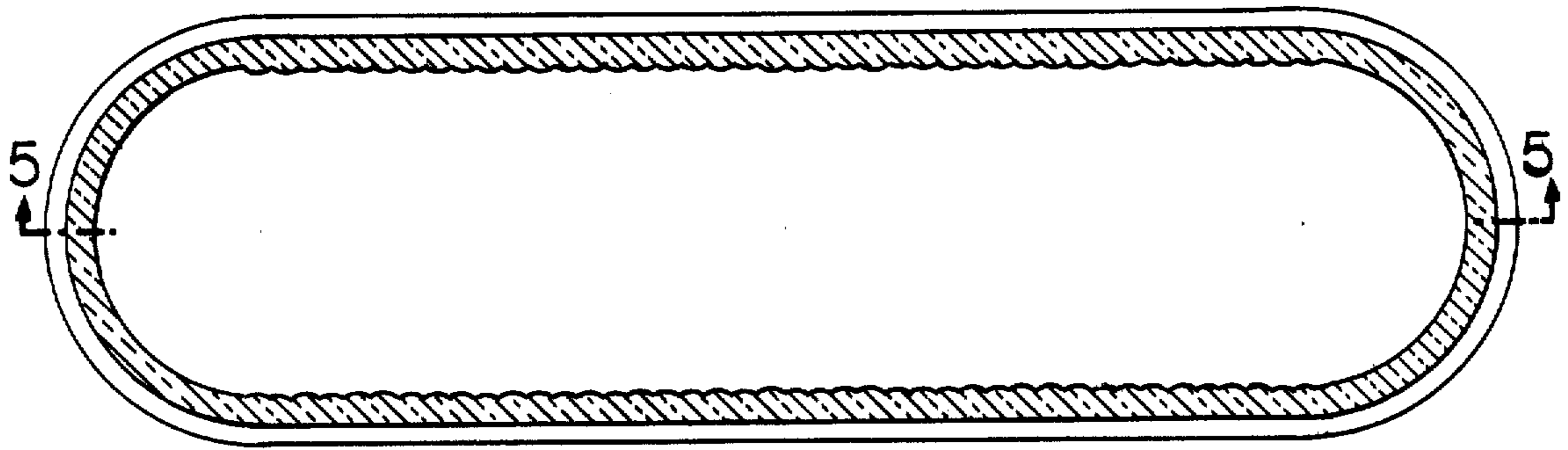

FIG. 4

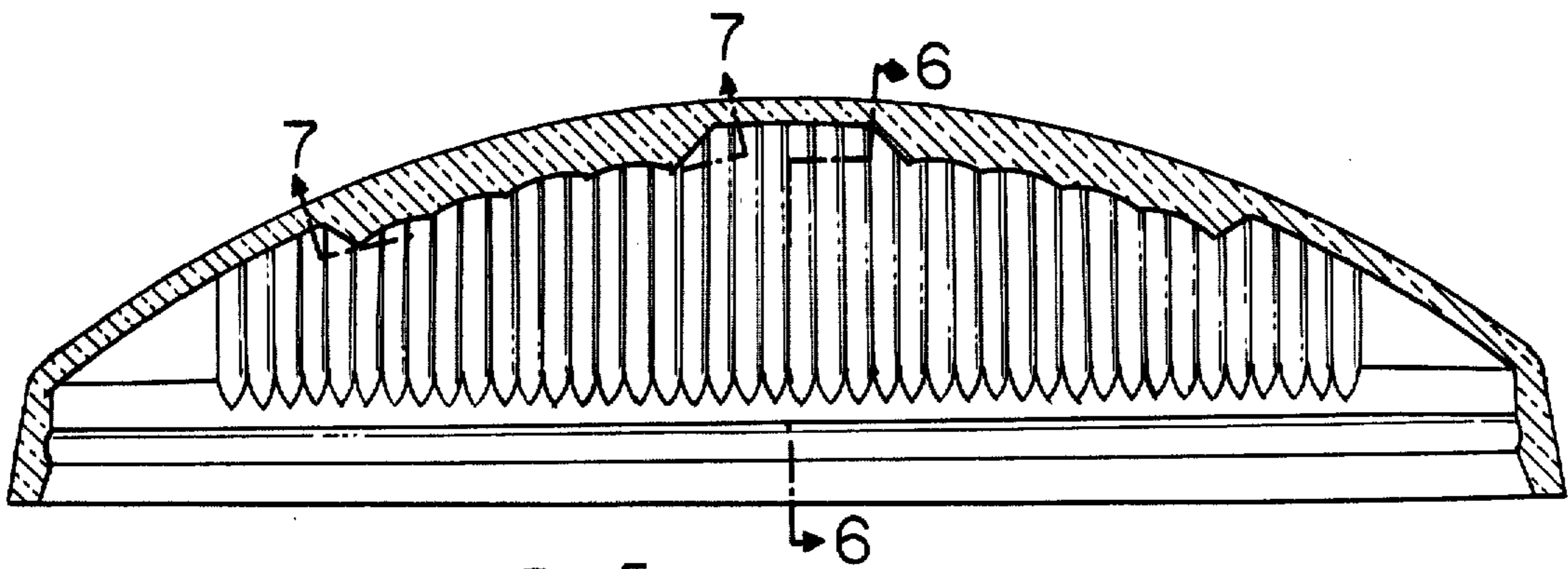

FIG. 5

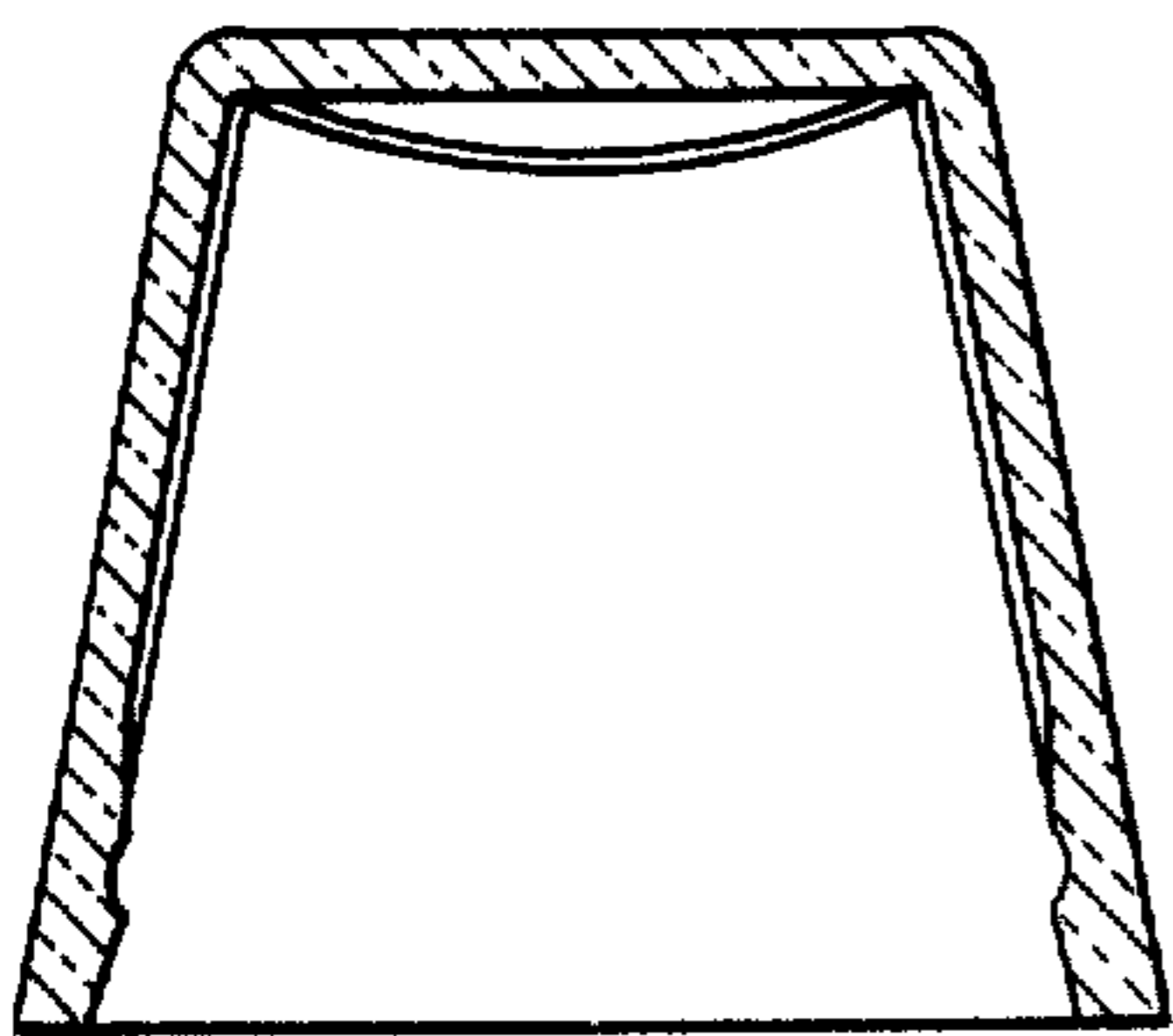

FIG. 6

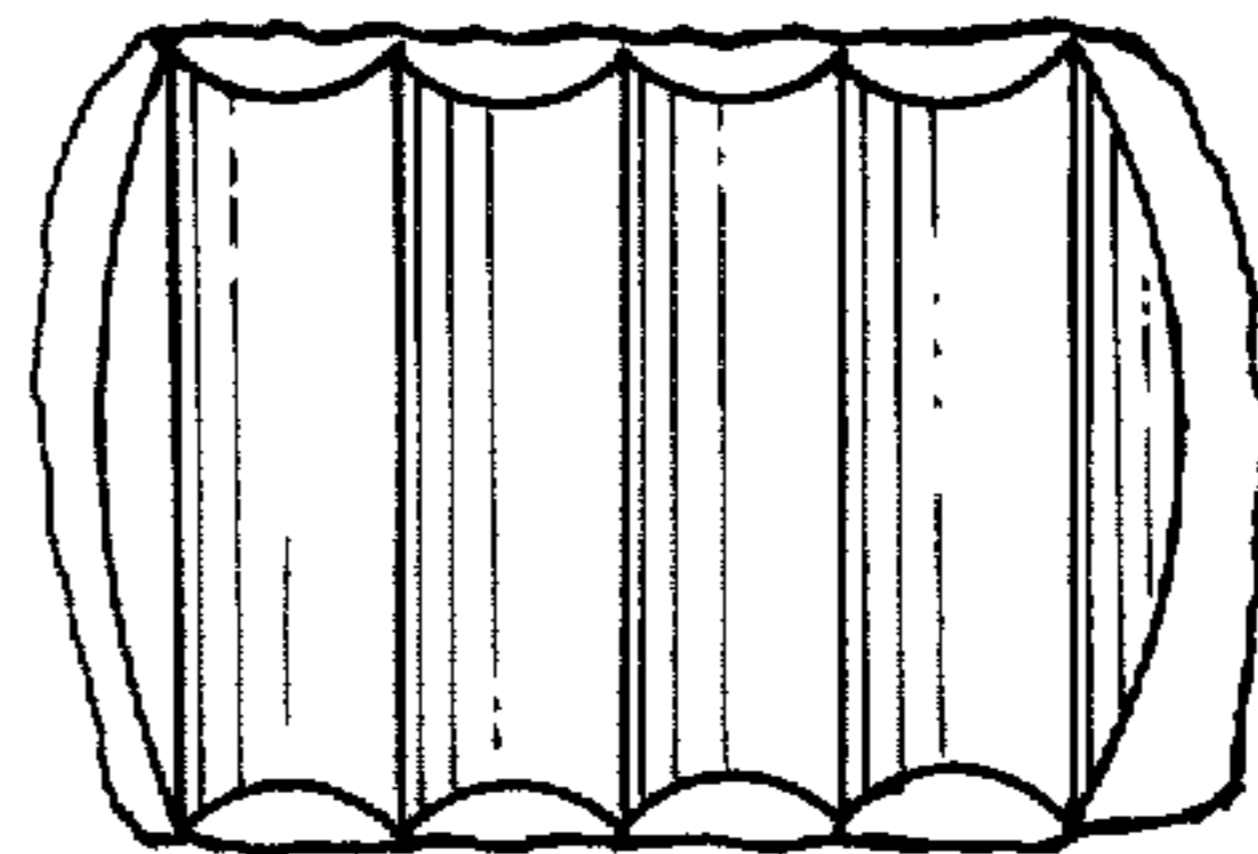

FIG. 7