

[54] FINGER FOOD ATTACHMENT TRAY FOR A SAUCER

[76] Inventor: Moyle A. Swinn, Apt. 716 - 1170 Ramsey View Crescent, Sudbury, Ontario, Canada, P3E 2E4

[\*\*] Term: 14 Years

[21] Appl. No.: 906,336

[22] Filed: May 16, 1978

[30] Foreign Application Priority Data

Dec. 20, 1977 [CA] Canada ..... 2012771

[51] Int. Cl. .... D7-99

[52] U.S. Cl. .... D7/39; D7/37

[58] Field of Search ..... D7/39, 52, 37, 38; 220/23.83

[56] References Cited

U.S. PATENT DOCUMENTS

- D. 23,980 1/1895 Johnson ..... D7/52
- D. 50,885 6/1917 Freid ..... D7/39
- D. 249,108 8/1978 Cannon, Jr. .... D7/39 X
- 292,651 1/1884 Hentschke ..... D7/39 X
- 2,795,121 6/1957 Pantello ..... D7/39 X

FOREIGN PATENT DOCUMENTS

- 2663 of 1898 United Kingdom ..... 220/23.83
- 245447 9/1926 United Kingdom ..... 220/23.83

Primary Examiner—Winifred E. Herrmann  
Attorney, Agent, or Firm—W. Irwin Haskett

[57] CLAIM

The ornamental design for a finger food attachment tray for a saucer, as shown and described.

DESCRIPTION

FIG. 1 is a side elevational view of a finger food attachment tray for a saucer showing my new design;  
 FIG. 2 is a top plan thereof;  
 FIG. 3 is a bottom plan thereof;  
 FIG. 4 is an elevational view on an enlarged scale as seen from the right of FIG. 1;  
 FIG. 5 is an elevational view on an enlarged scale as seen from the left of FIG. 1;  
 FIG. 6 is a top plan view on an enlarged scale of a modification of the design of FIGS. 1 to 5;  
 FIG. 7 is a top perspective view of the design of FIGS. 1-5;  
 FIG. 8 is a bottom perspective view thereof;  
 FIG. 9 is a top perspective view of the design of FIG. 6; and  
 FIG. 10 is a bottom perspective view thereof.

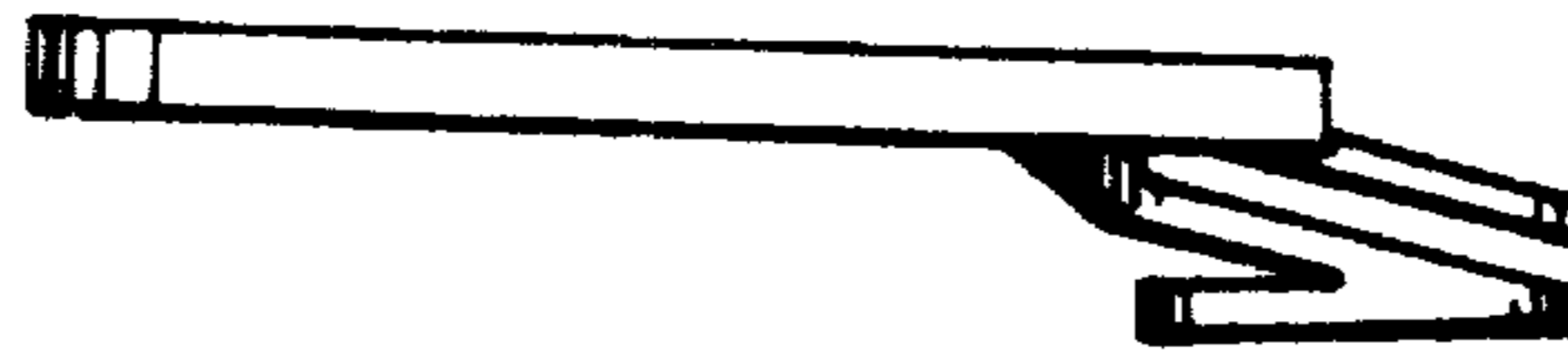

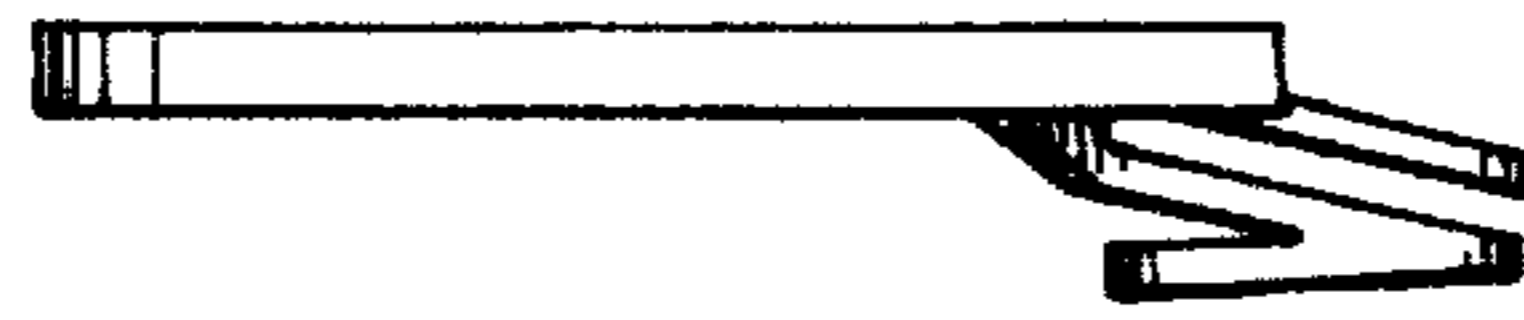

FIG. 1

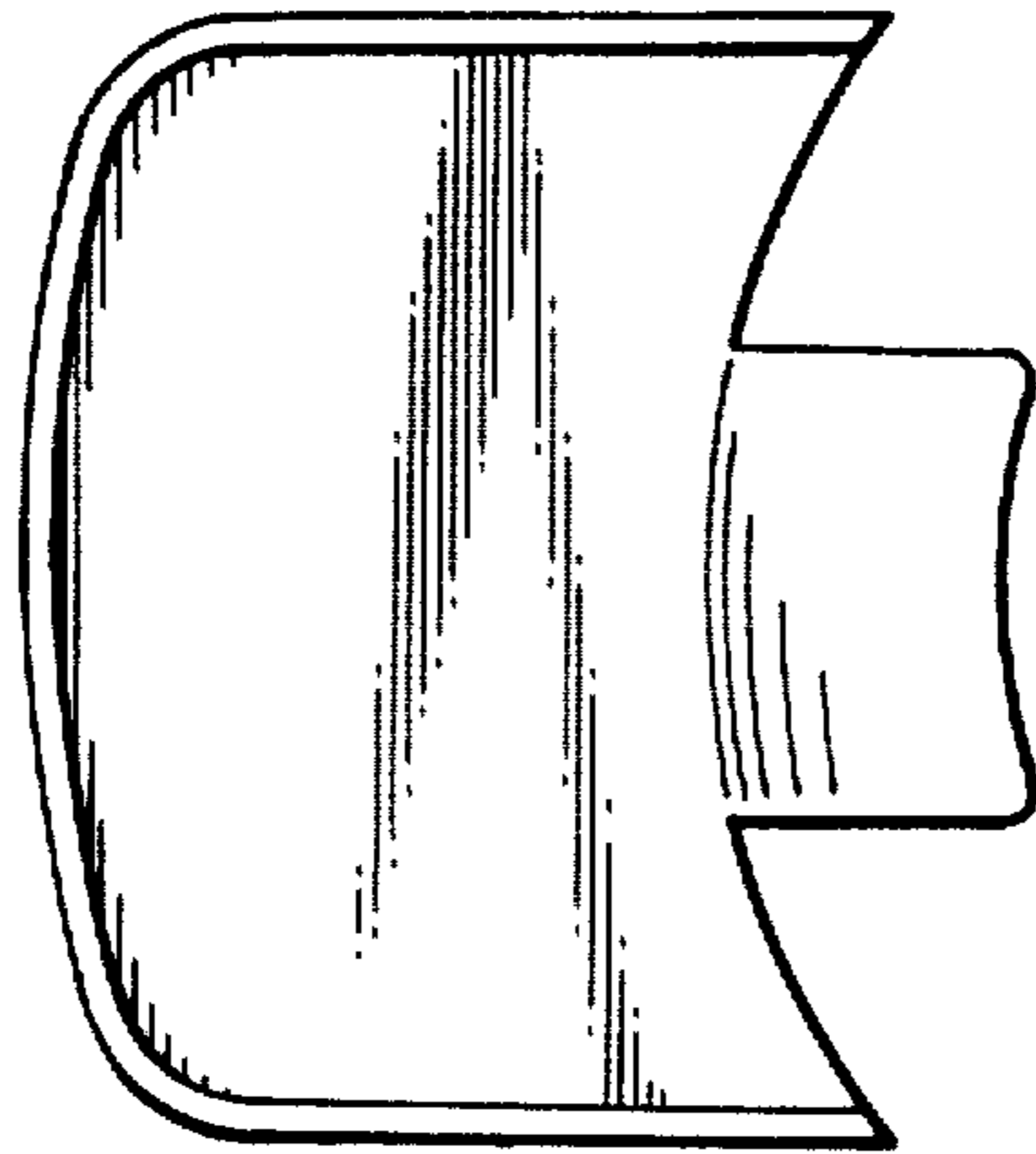

FIG. 2

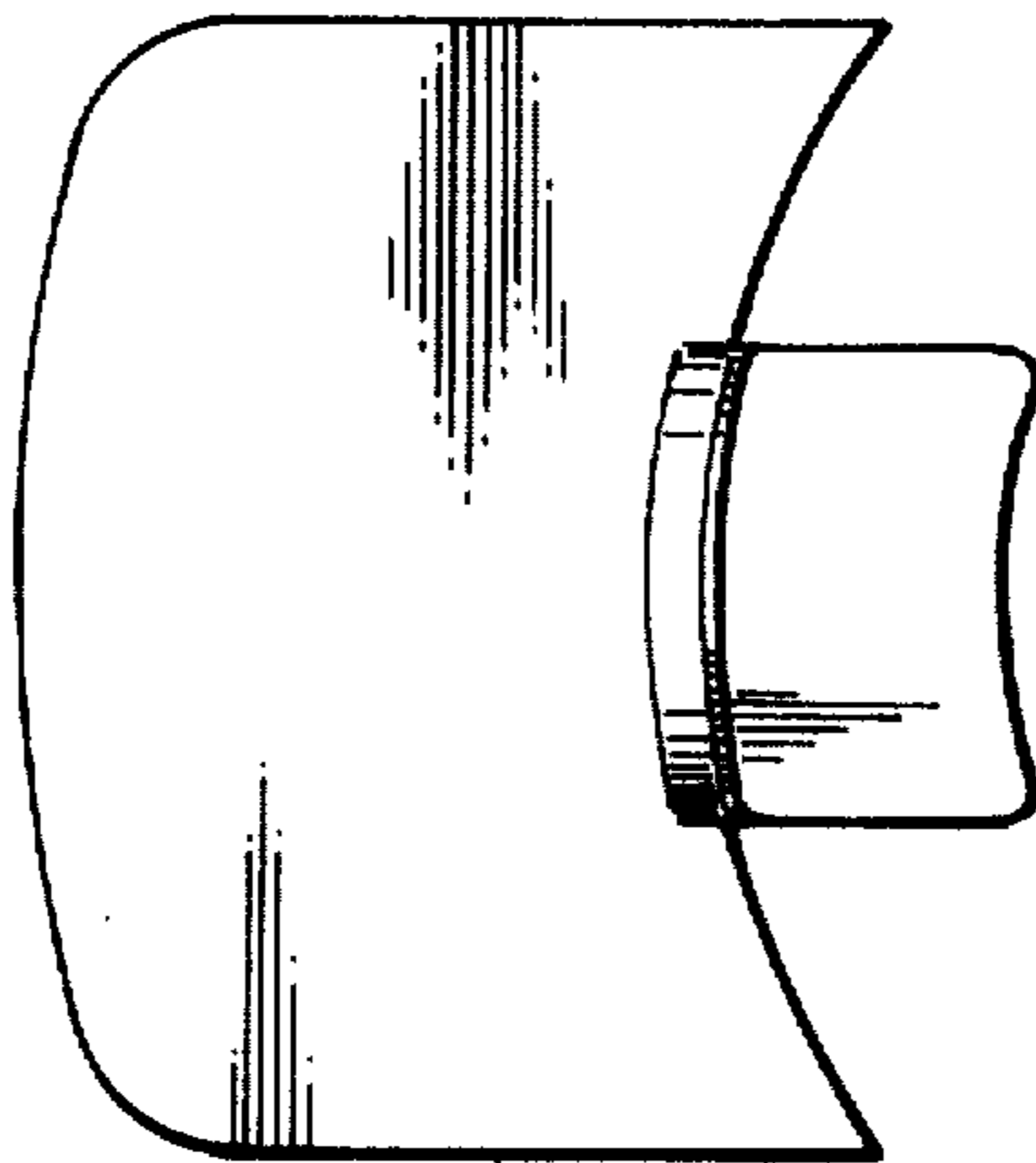

FIG. 3

FIG. 4.

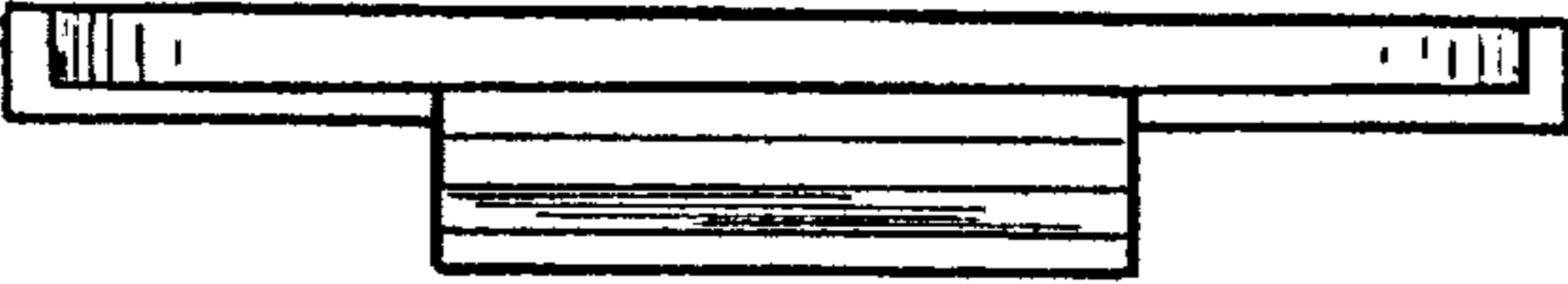

FIG. 5.

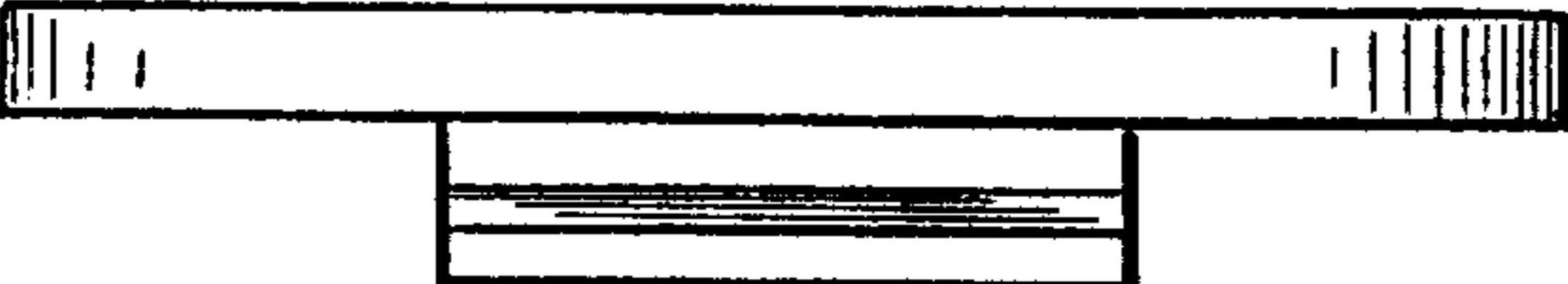

FIG. 6.

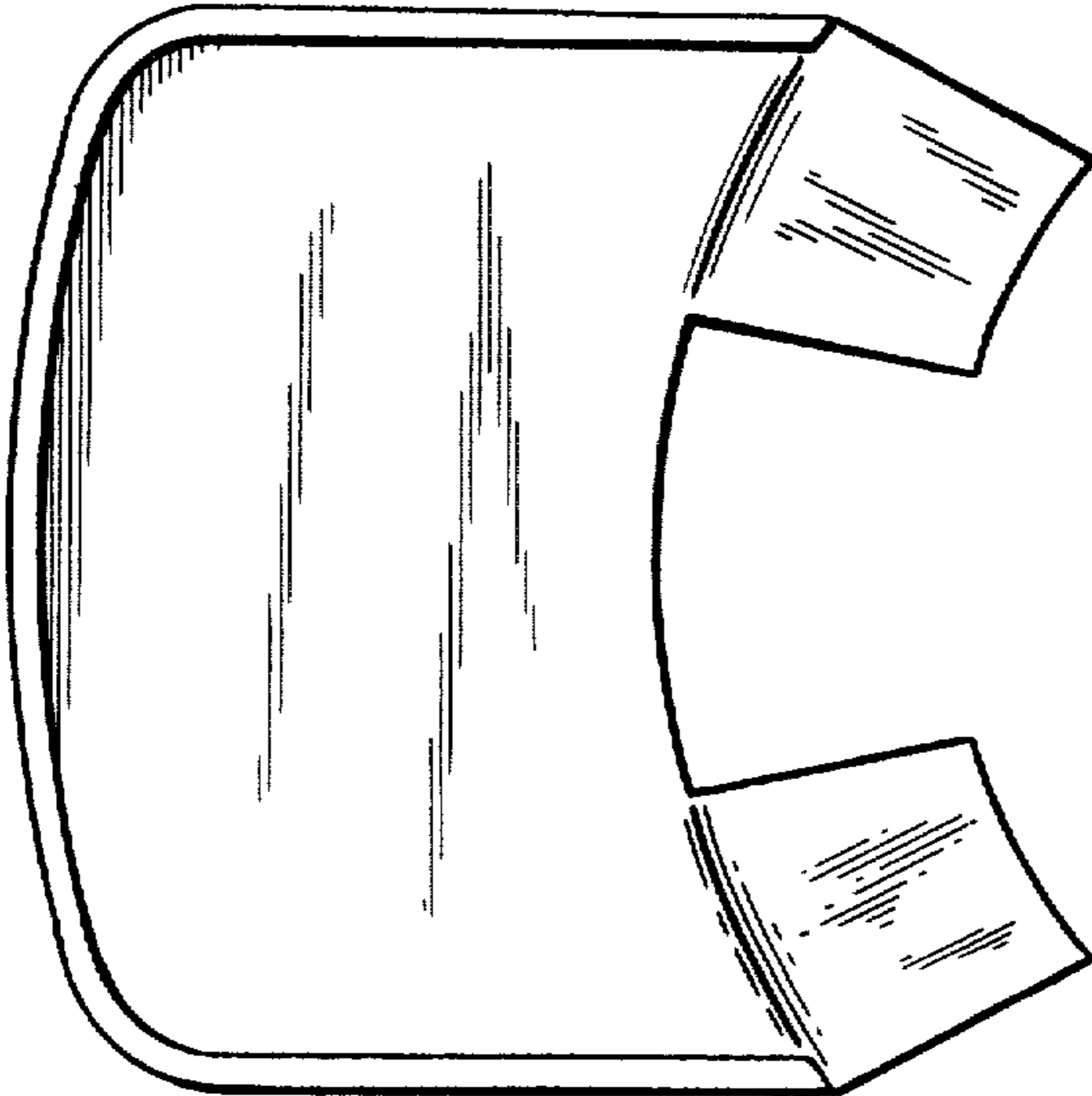



FIG. 7

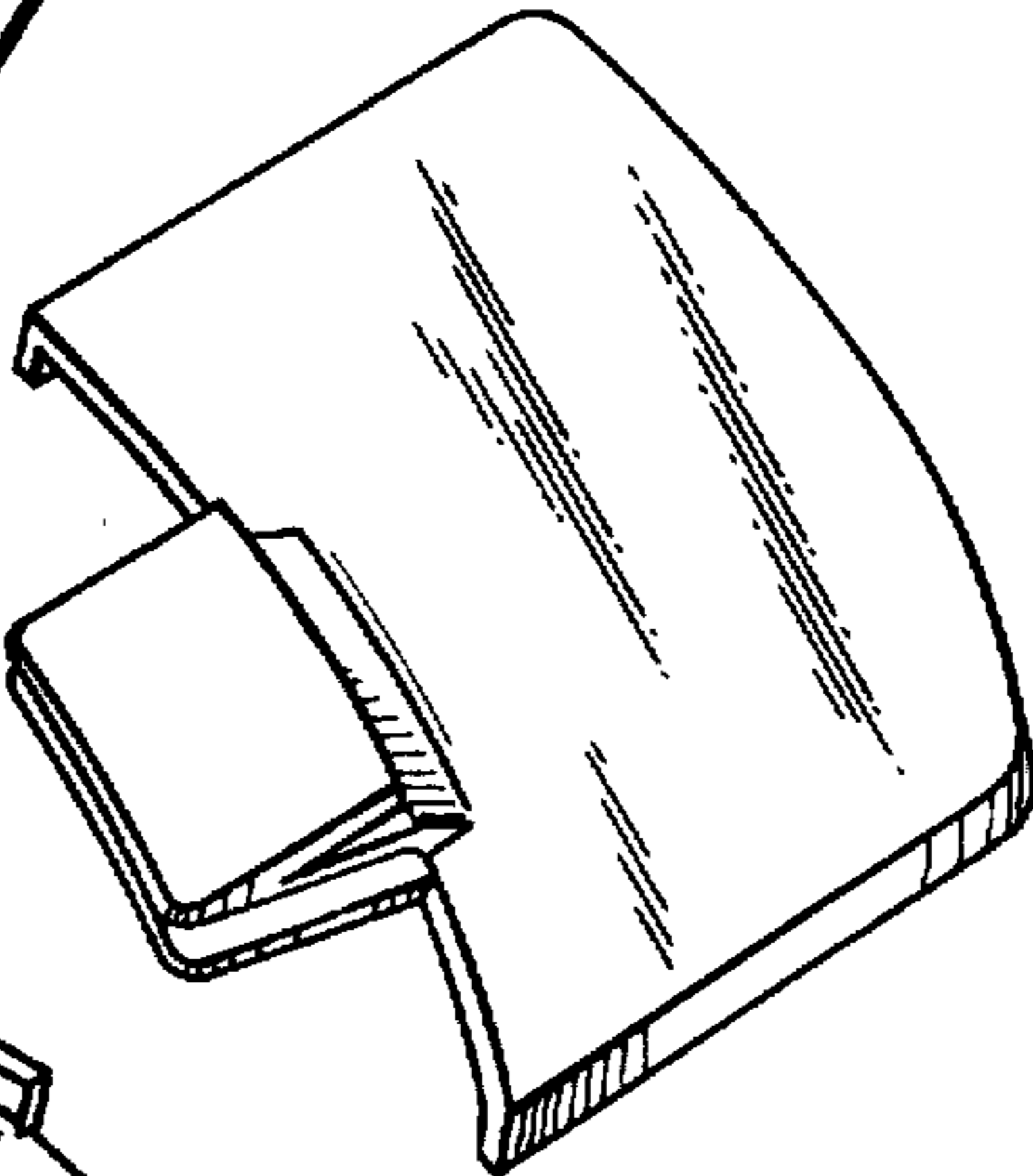

FIG. 8

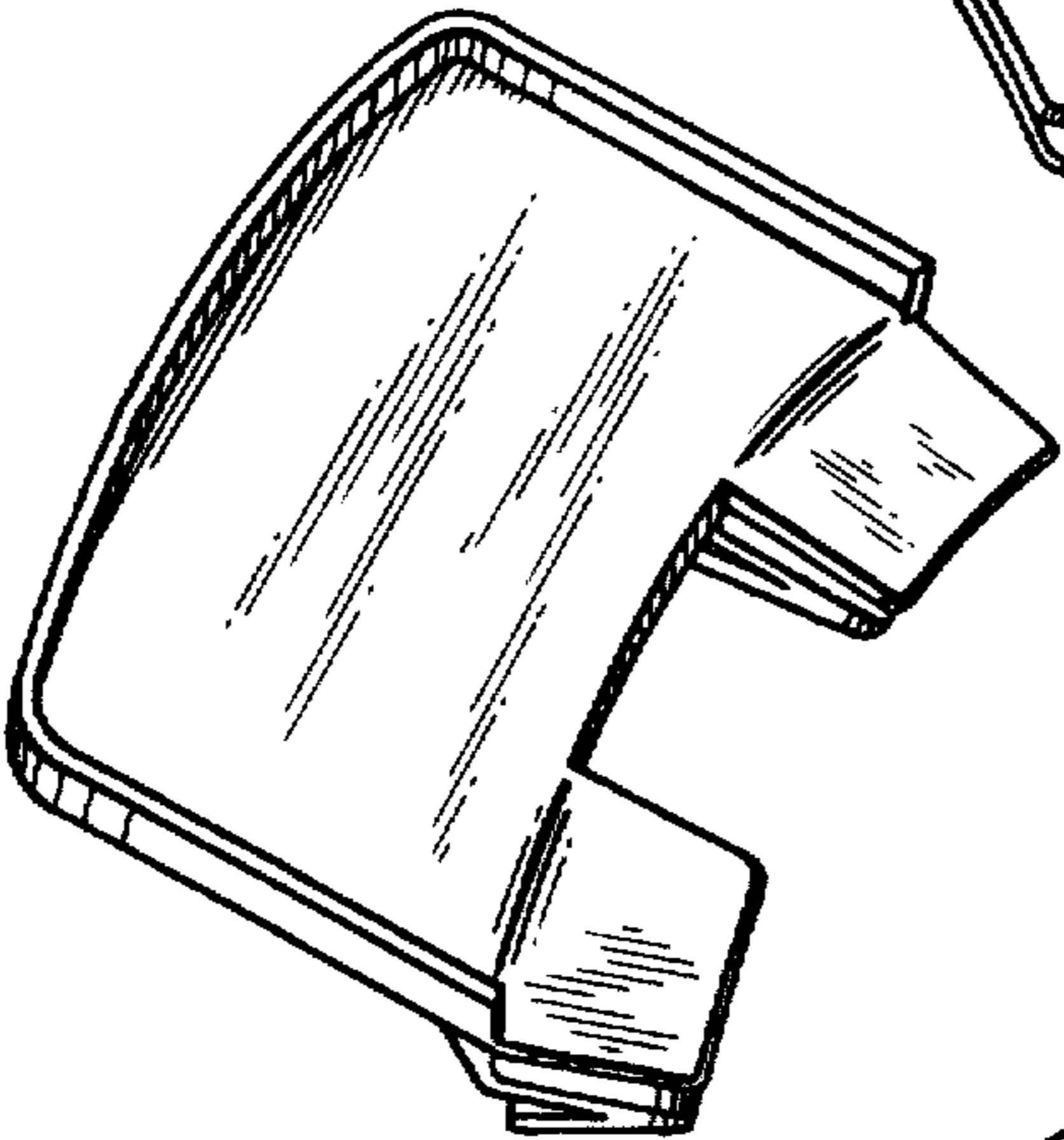

FIG. 9

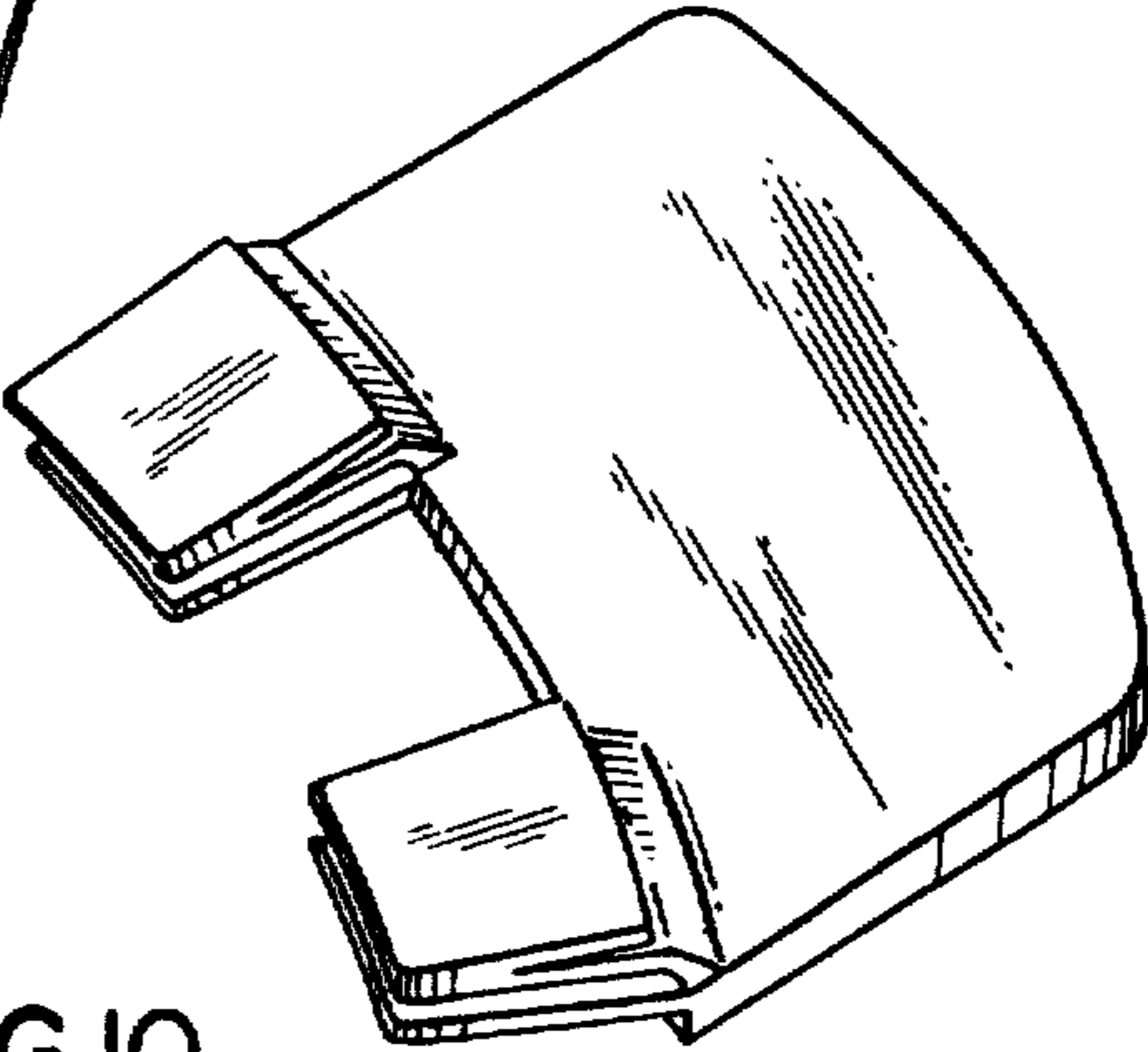

FIG. 10