

[54] LUGGAGE

[75] Inventor: Ted Stark, Jersey City, N.J.

[73] Assignee: M & M Luggage Co., Inc., Jersey City, N.J.

[**] Term: 14 Years

[21] Appl. No.: 933,724

[22] Filed: Aug. 14, 1978

[51] Int. Cl. D3-01

[52] U.S. Cl. D3/71; D3/77

[58] Field of Search D3/71, 76, 77; 150/1; 190/41.12, 41.2, 53

[56] References Cited

U.S. PATENT DOCUMENTS

- D. 63,167 10/1923 Axelman et al. D3/76
- D. 248,188 6/1978 Tweedie D3/71
- D. 251,332 3/1979 Davis D3/77

OTHER PUBLICATIONS

Luggage & Leather Goods, 7/76, front cover.

Primary Examiner—George P. Word
Attorney, Agent, or Firm—Hubbell, Cohen, Stiefel & Gross

[57] CLAIM

The ornamental design for luggage, substantially as shown and described.

DESCRIPTION

FIG. 1 is a rear perspective view of luggage showing my new design;
 FIG. 2 is a top plan view;
 FIG. 3 is a front elevational view;
 FIG. 4 is a right side elevational view of FIG. 3;
 FIG. 5 is a bottom plan view thereof;
 FIG. 6 is a perspective view of a modified form of the luggage;
 FIG. 7 is a rear elevational view thereof;
 FIG. 8 is a left side elevational view thereof; and
 FIG. 9 is a bottom plan view thereof.



FIG. 1.

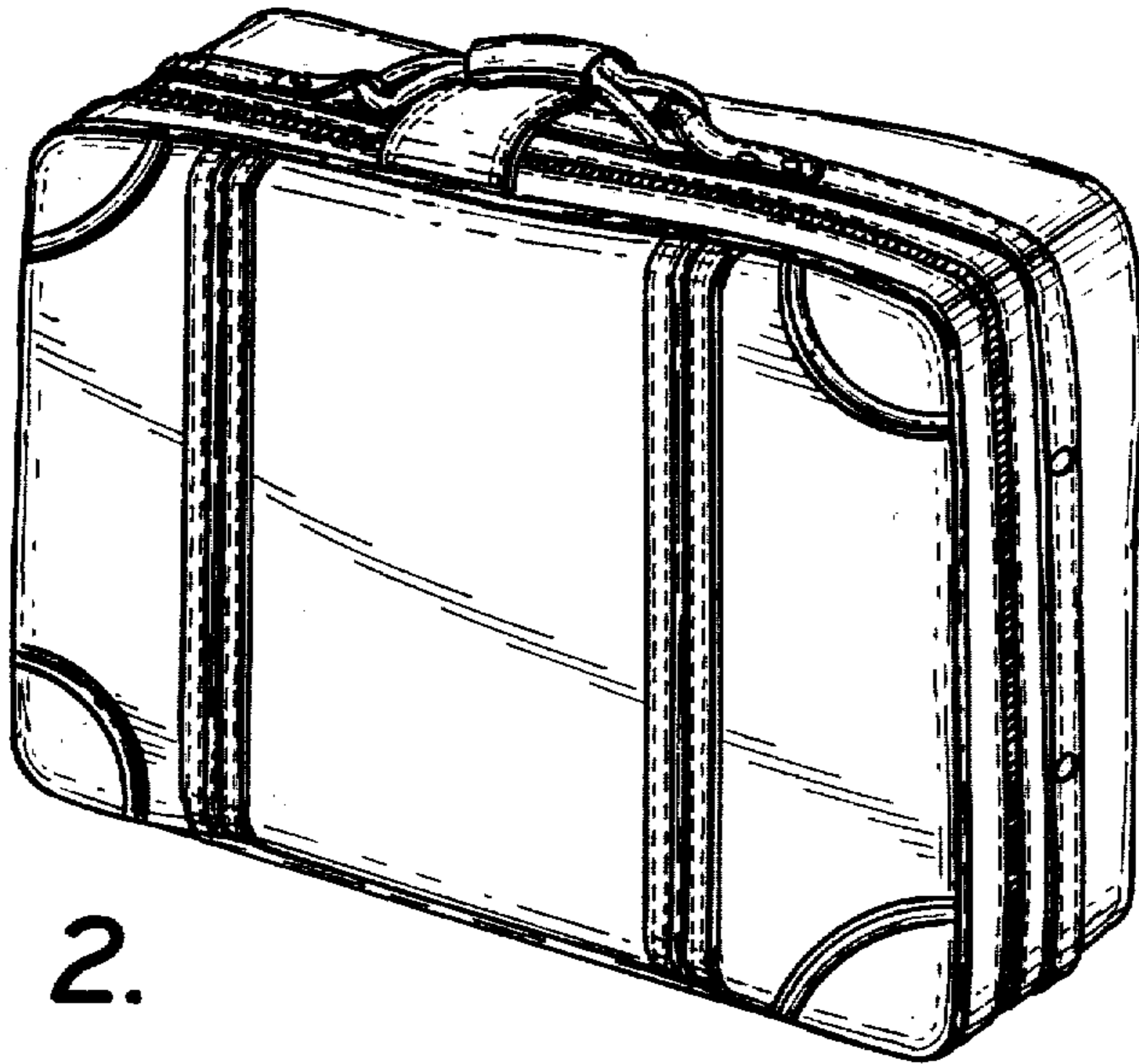

FIG. 4.

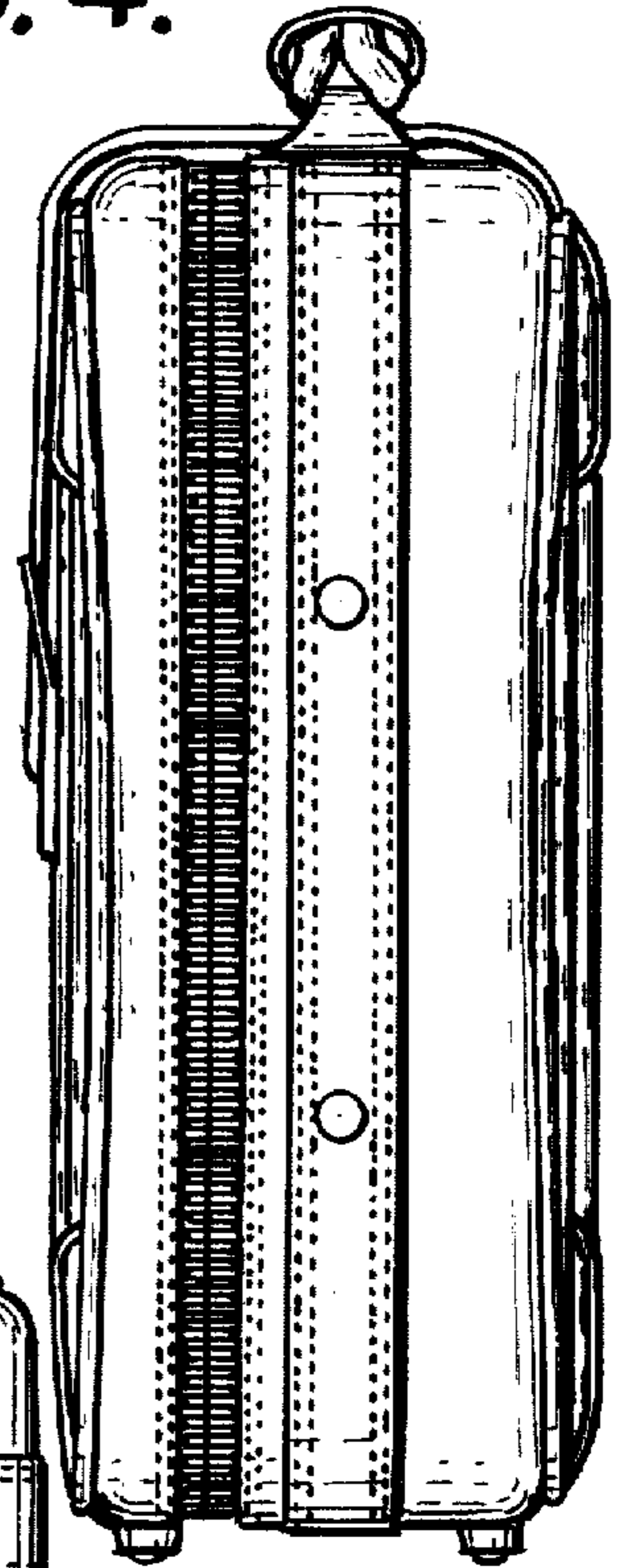

FIG. 2.

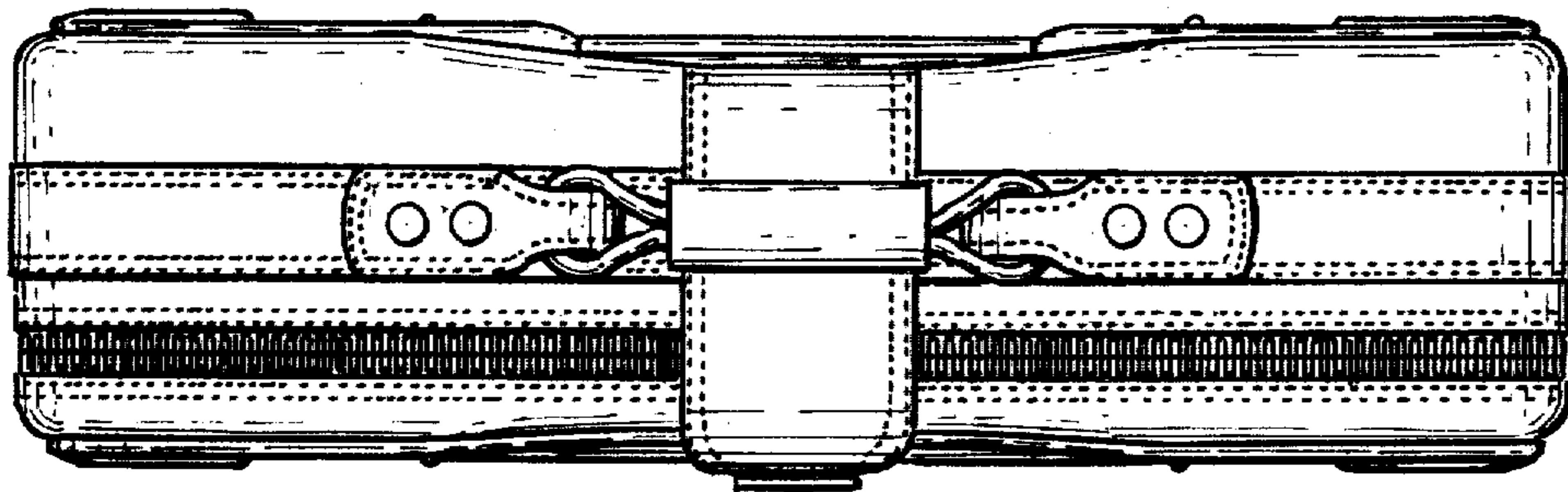

FIG. 3.

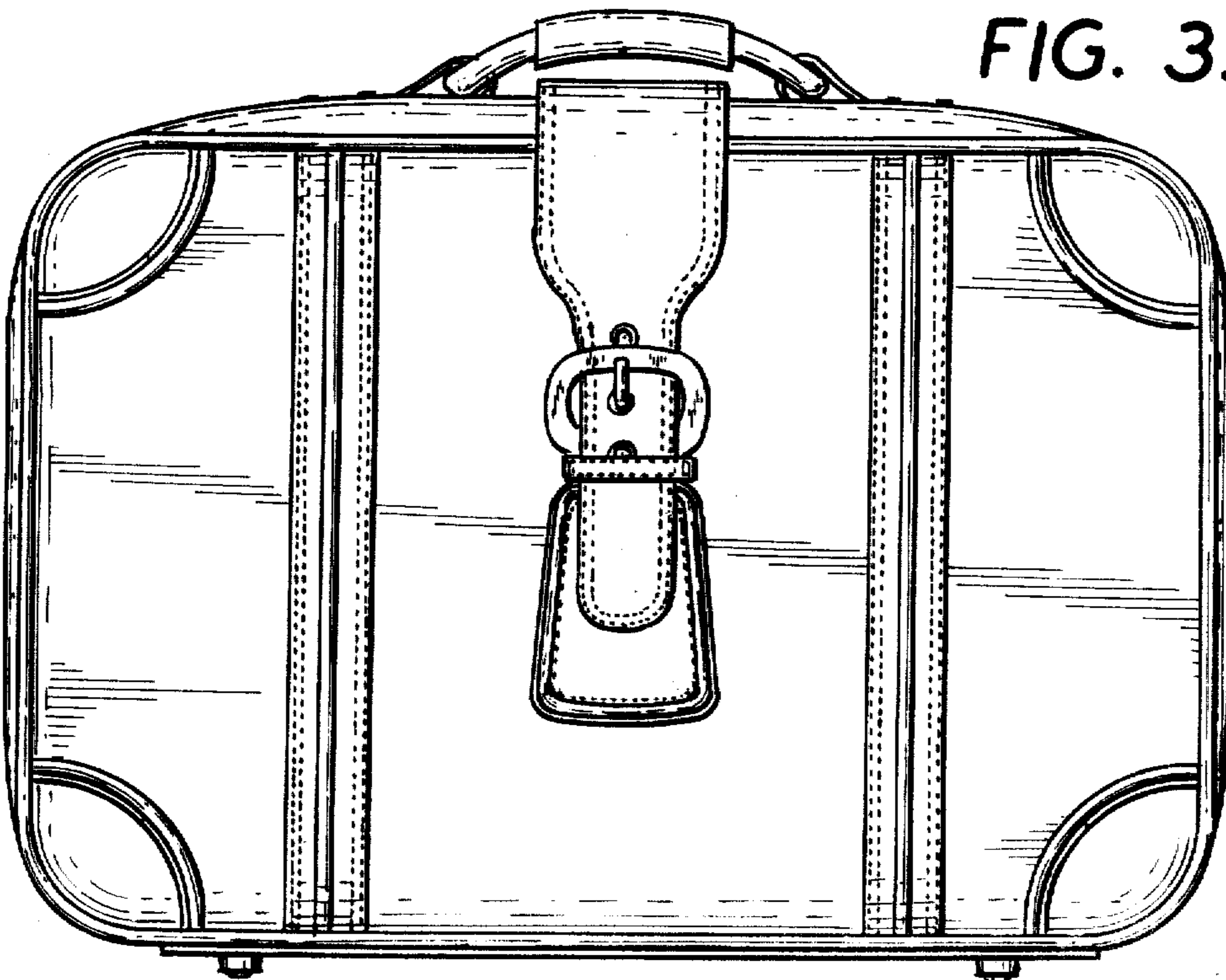

FIG. 5.

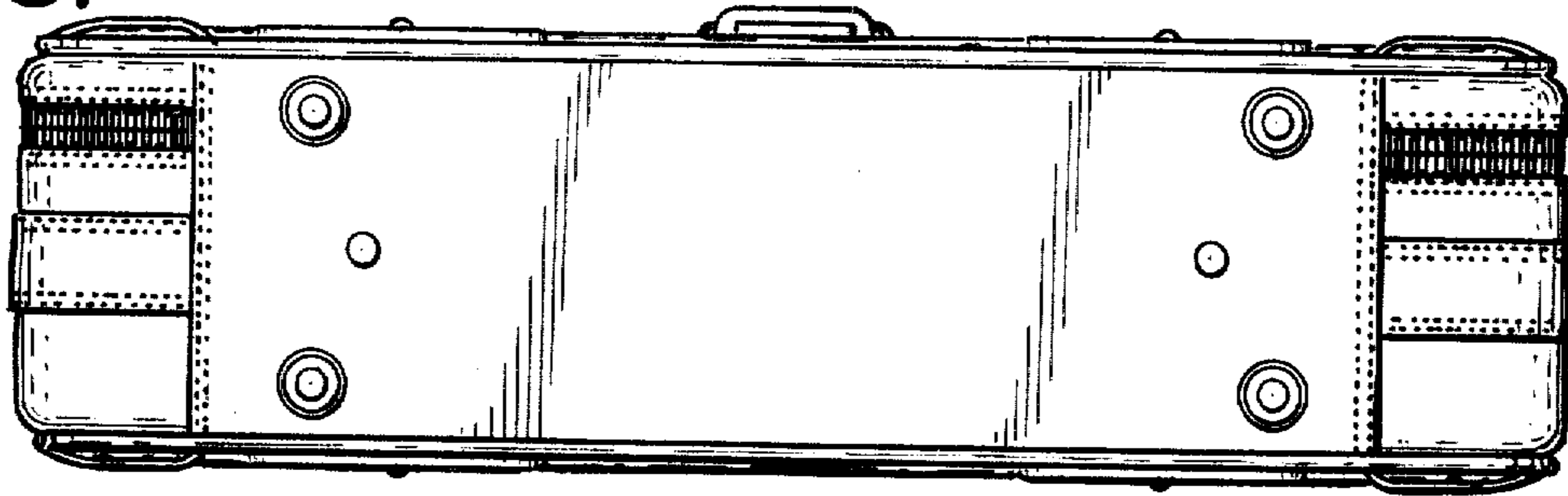

FIG. 6.

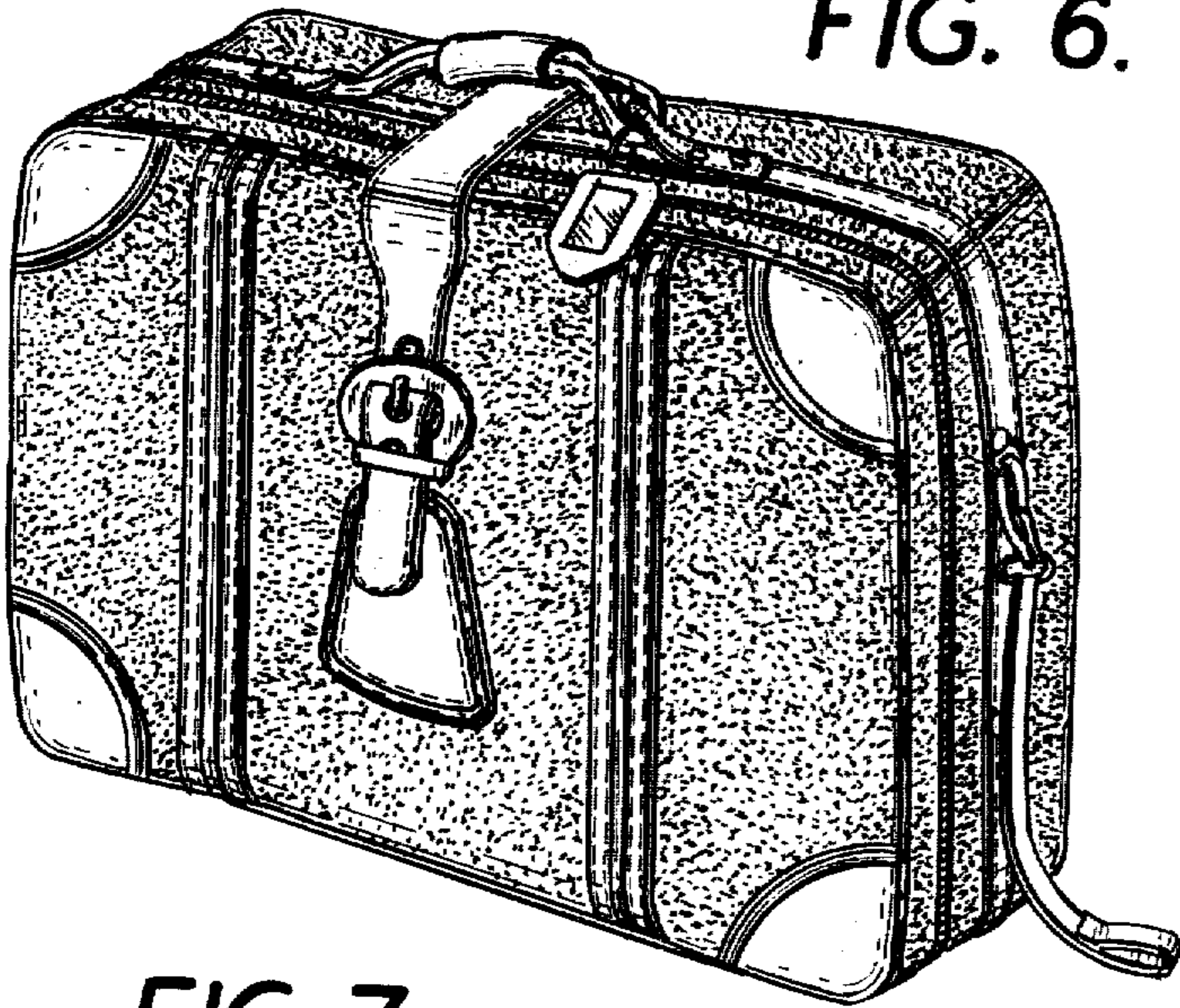

FIG. 8.

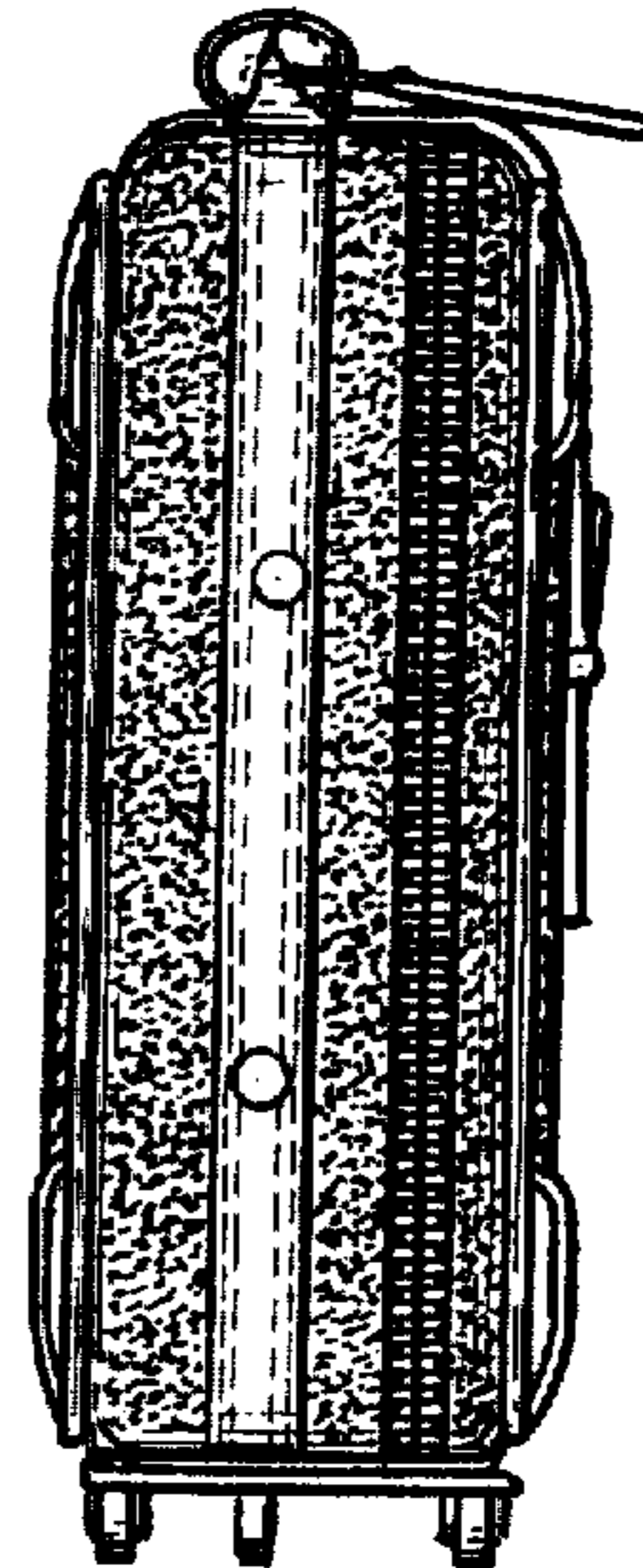

FIG. 7.

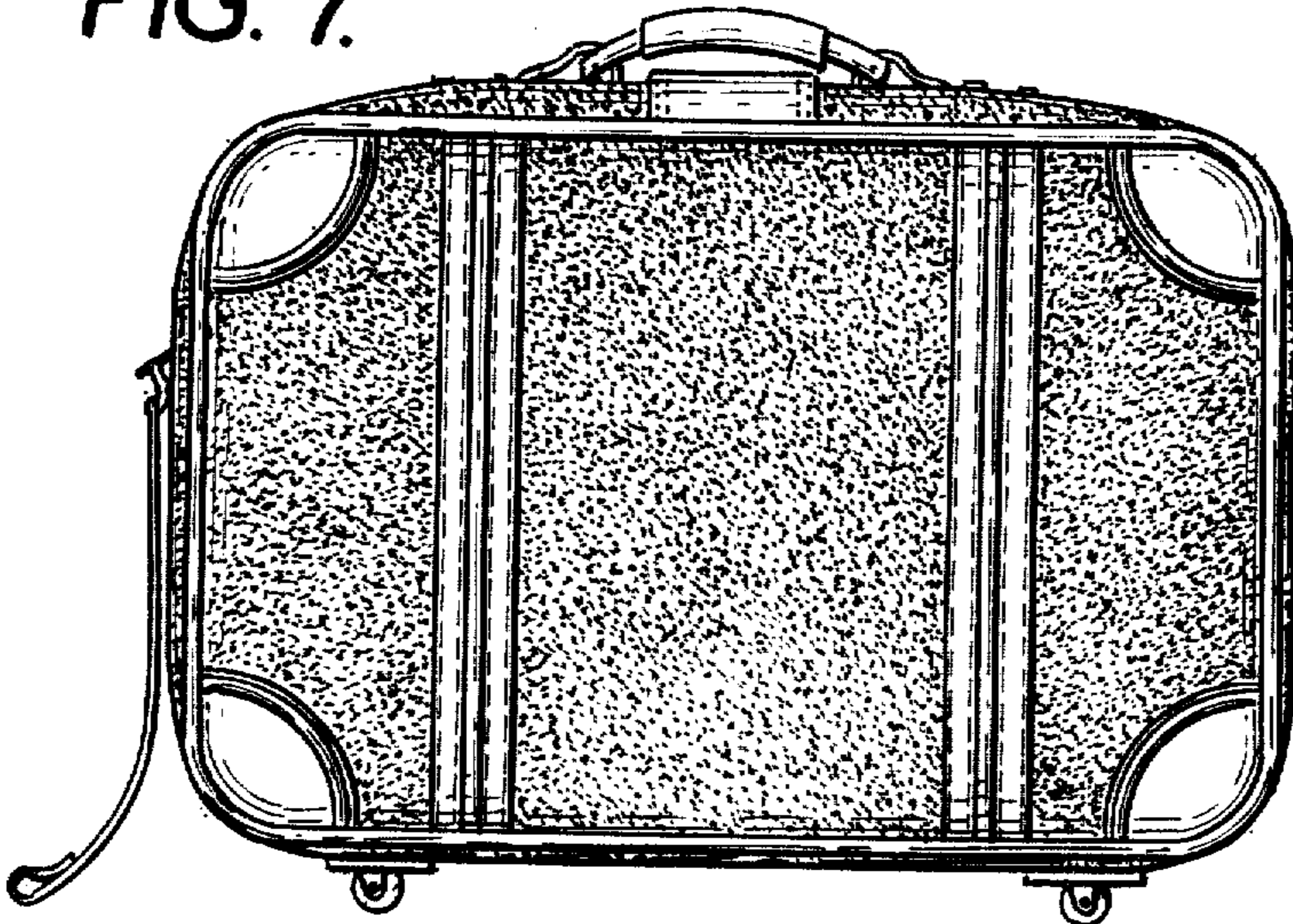

FIG. 9.

