

[54] COMBINED APPLIANCE SUPPORT AND RETRACTABLE WORKING SURFACE

[75] Inventor: Charles E. Dunn, Cartersville, Ga.

[73] Assignee: Wood Valley Industries, Inc., Cartersville, Ga.

[**] Term: 14 Years

[21] Appl. No.: 188,389

[22] Filed: Sep. 18, 1980

[51] Int. Cl. D07-04; D07-99

[52] U.S. Cl. D7/46; D7/130

[58] Field of Search D7/46, 41, 37, 38, 130, D7/85, 21; 269/302.1, 289; D6/158, 192

[56] References Cited

U.S. PATENT DOCUMENTS

D. 232,799 9/1974 Knudson D7/46
3,947,012 3/1976 Cobb D7/46 X

FOREIGN PATENT DOCUMENTS

175343 2/1917 Canada 269/289

OTHER PUBLICATIONS

W. Bell & Co. 1979 Catalog, ©1978, p. 292, Item M--Chopping Block With Concealed Tray, lower left area.

W. Bell & Co. 1979 Catalog, ©1978, p. 293, Item A--Tray With Tile, top left corner.

Primary Examiner--Winifred E. Herrmann
Attorney, Agent, or Firm--Rodgers & Rodgers

[57] CLAIM

The ornamental design for a combined appliance support and retractable working surface, as shown and described.

DESCRIPTION

FIG. 1 is an isometric view of a combined appliance support and retractable working surface showing my new design;

FIG. 2 is a top plan view thereof;

FIG. 3 is a bottom plan view thereof;

FIG. 4 is a front elevational view thereof;

FIG. 5 is a side elevational view thereof;

FIG. 6 is a rear elevational view thereof;

FIG. 7 is an isometric view of a combined appliance support and retractable working surface with the working surface shown in the extended position;

FIG. 8 is a top plan view thereof;

FIG. 9 is a bottom plan view thereof; and

FIG. 10 is a side elevational view thereof; the front and rear elevational views thereof corresponding to FIGS. 4 and 6 respectively.

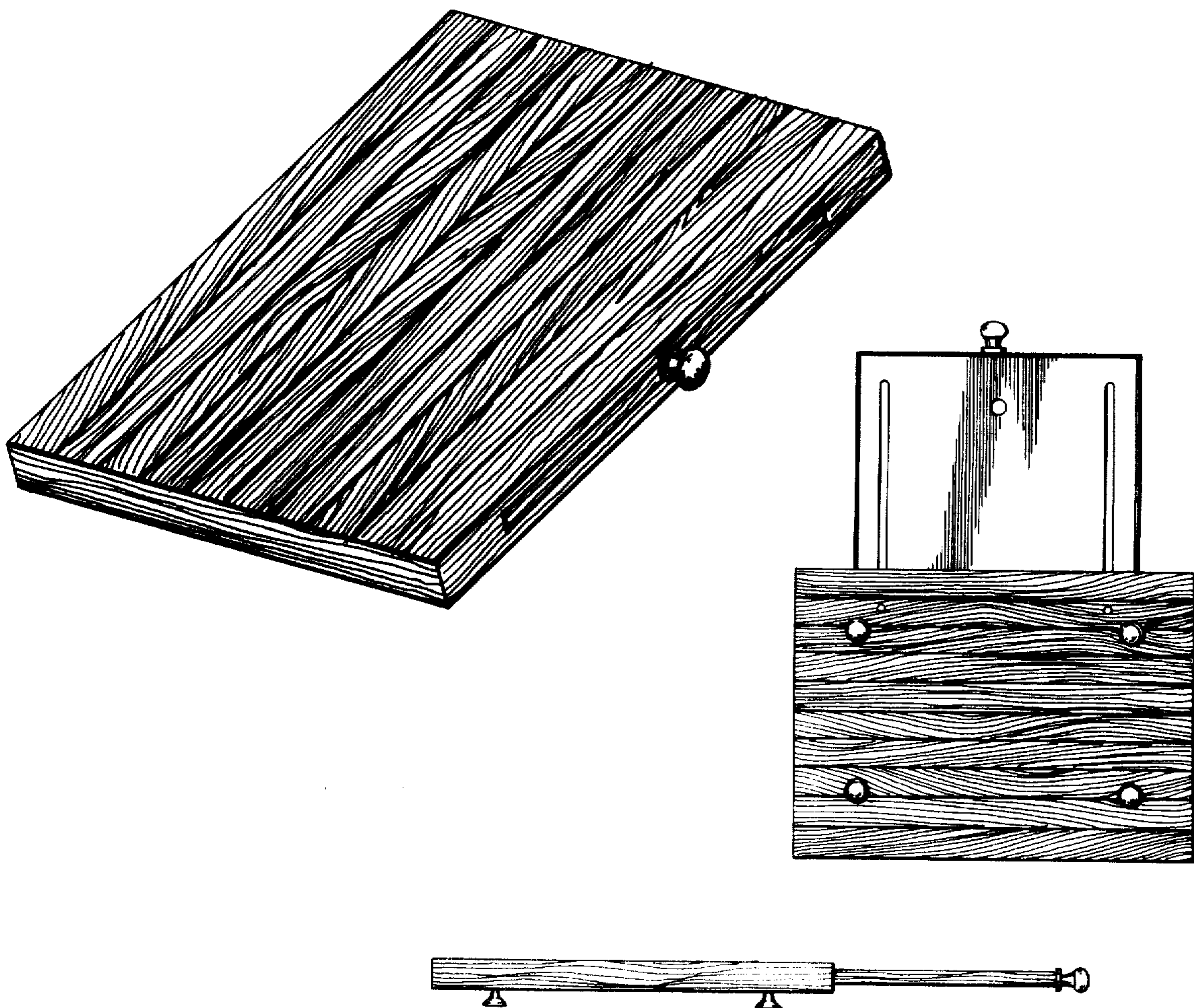

Fig. 1

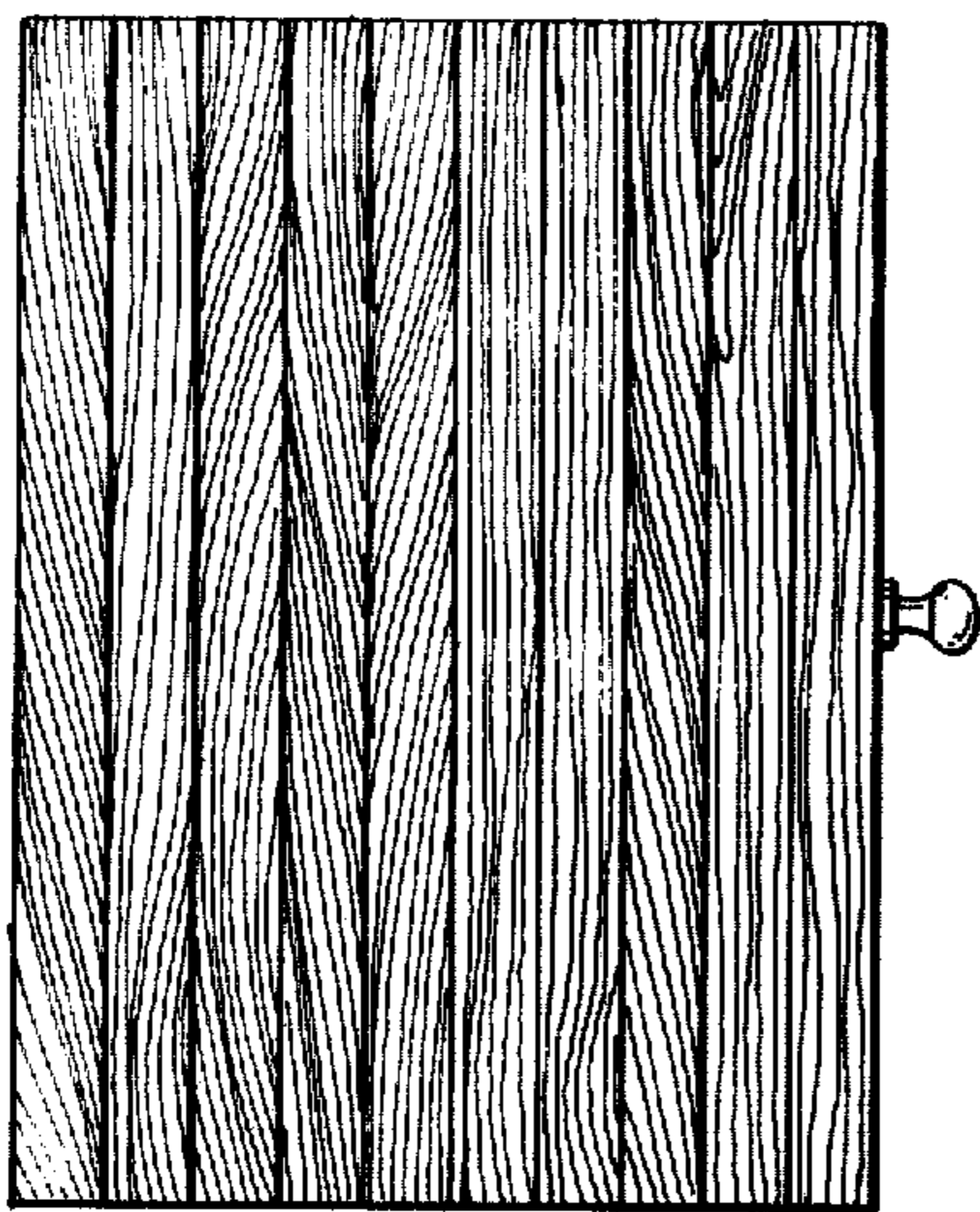
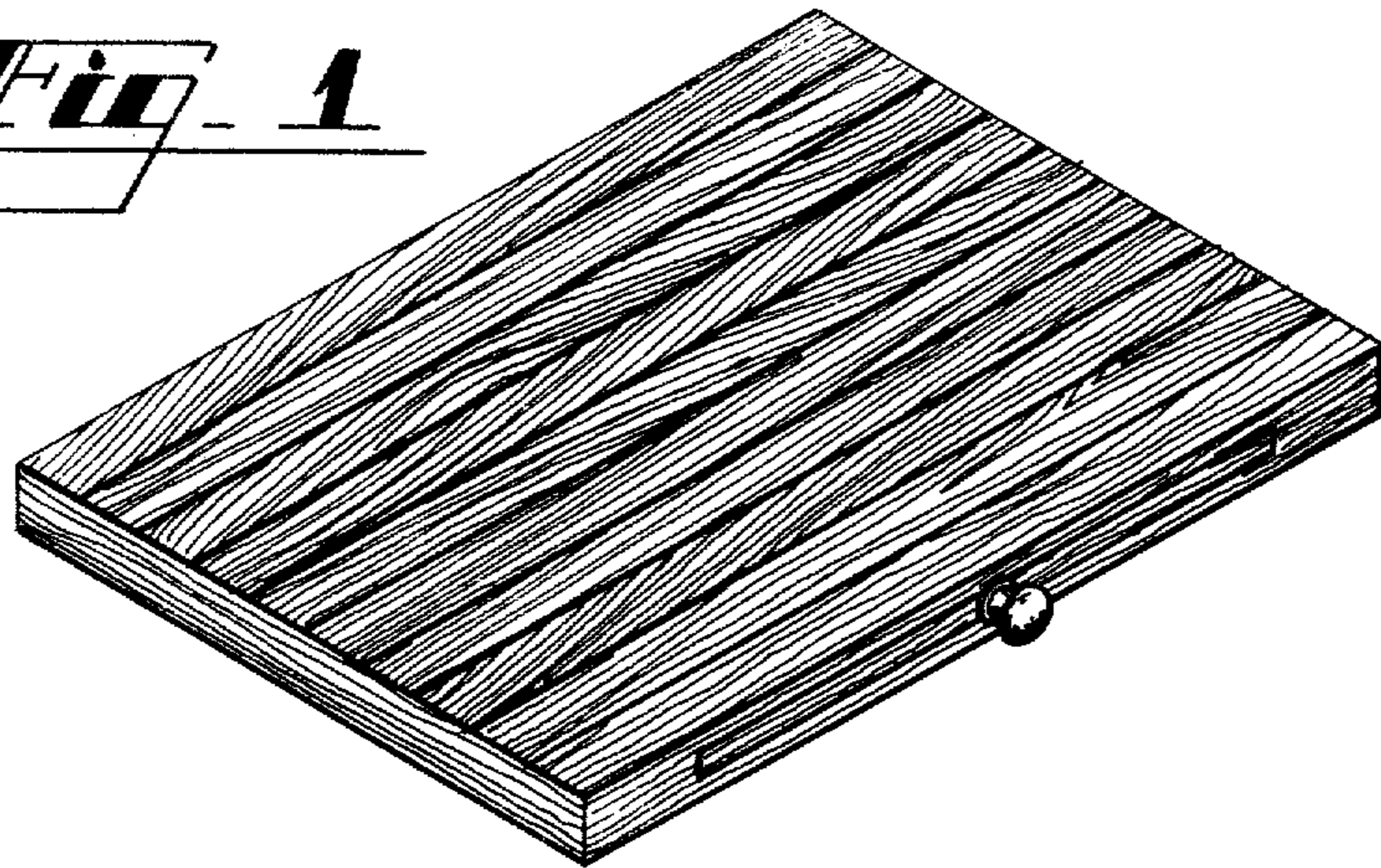

Fig. 2

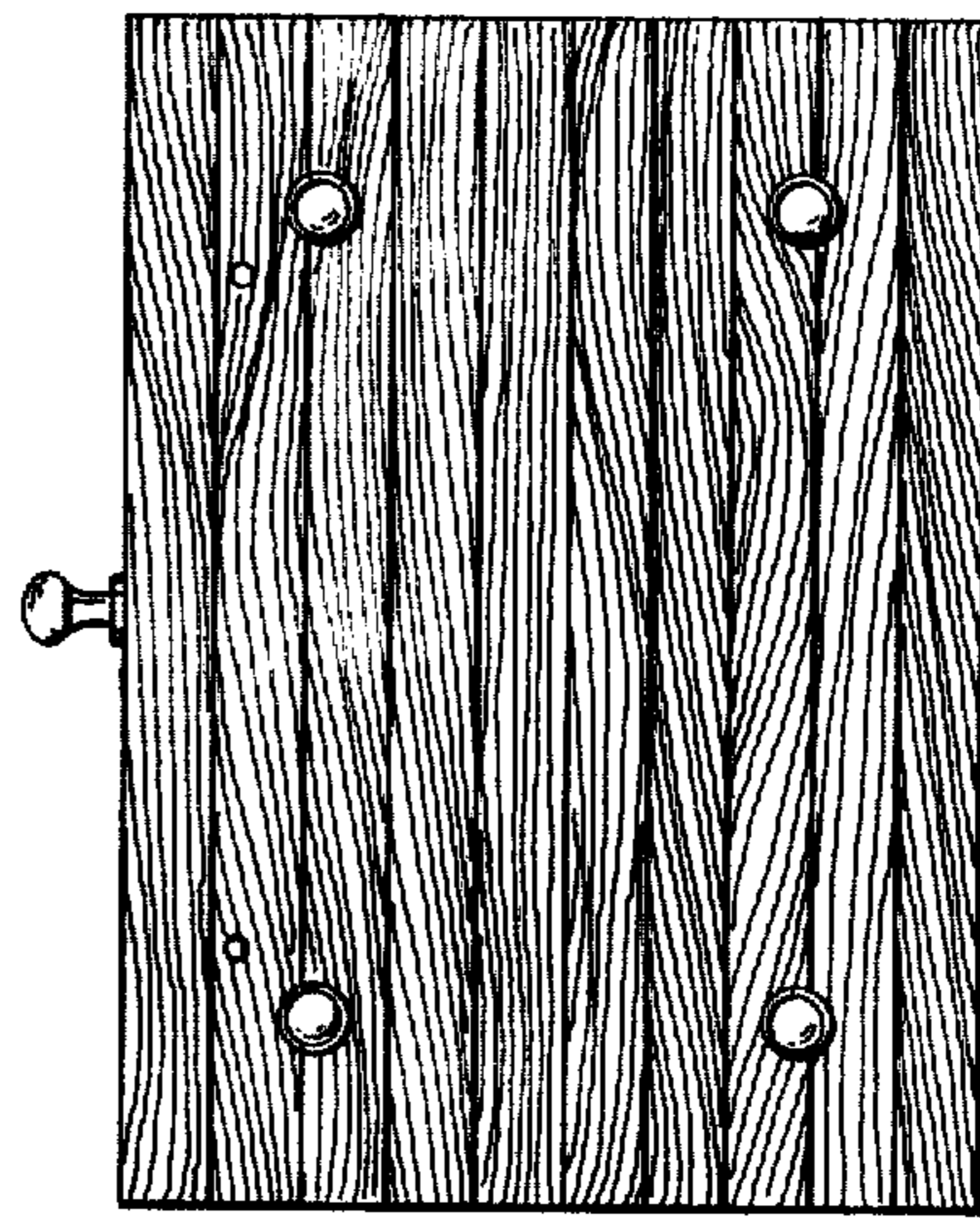

Fig. 3



Fig. 4

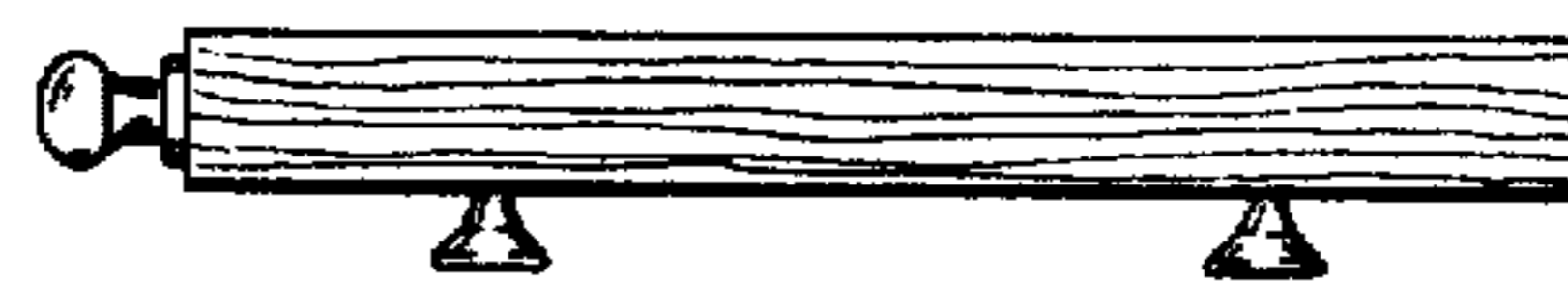

Fig. 5

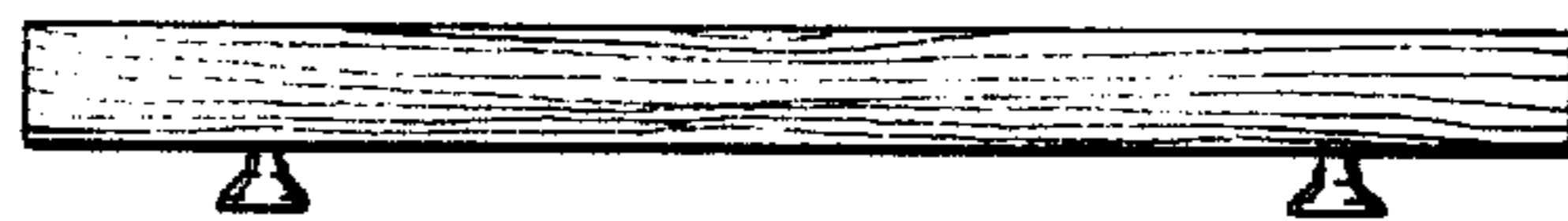

Fig. 6

Fig. 7

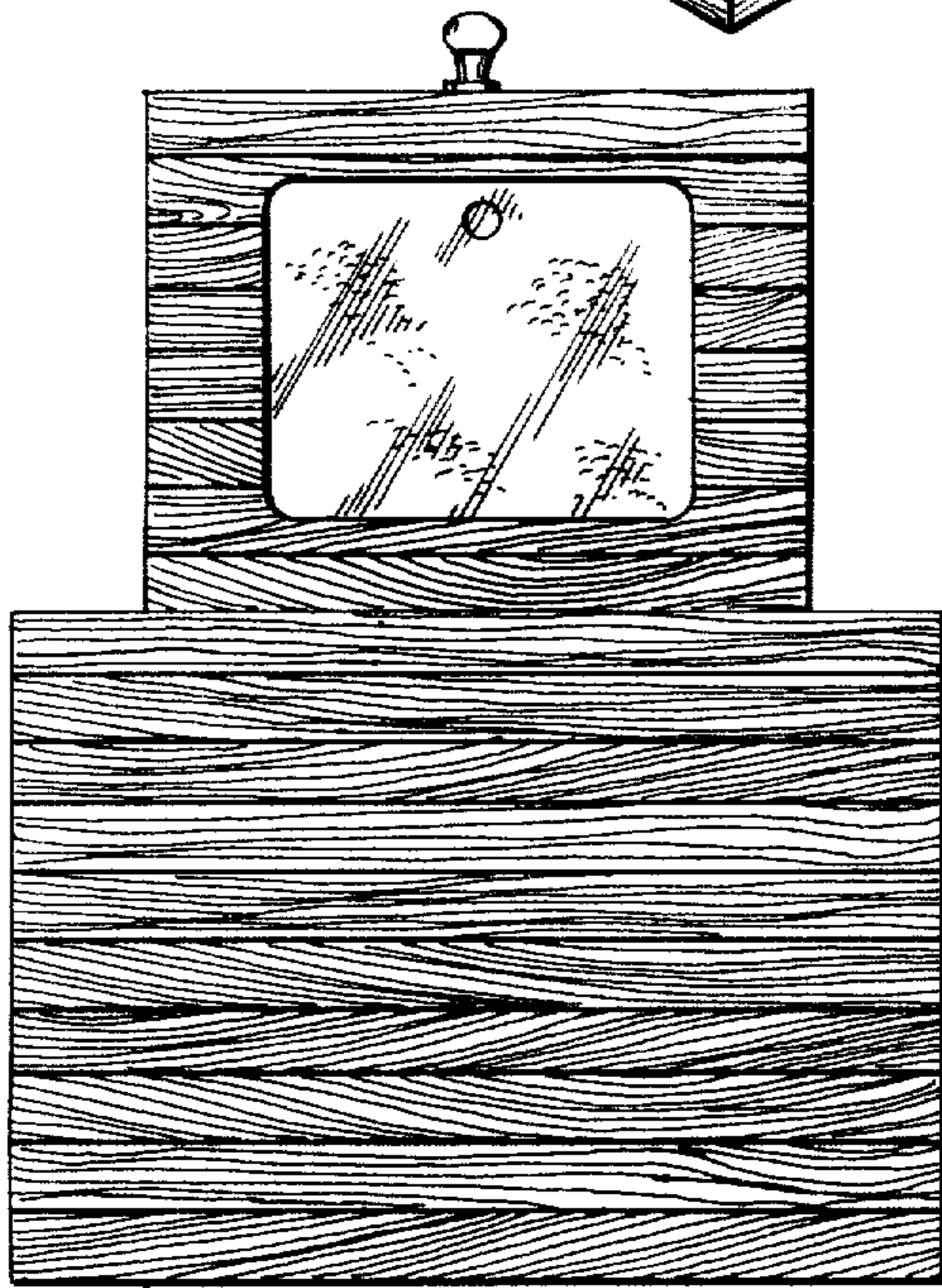
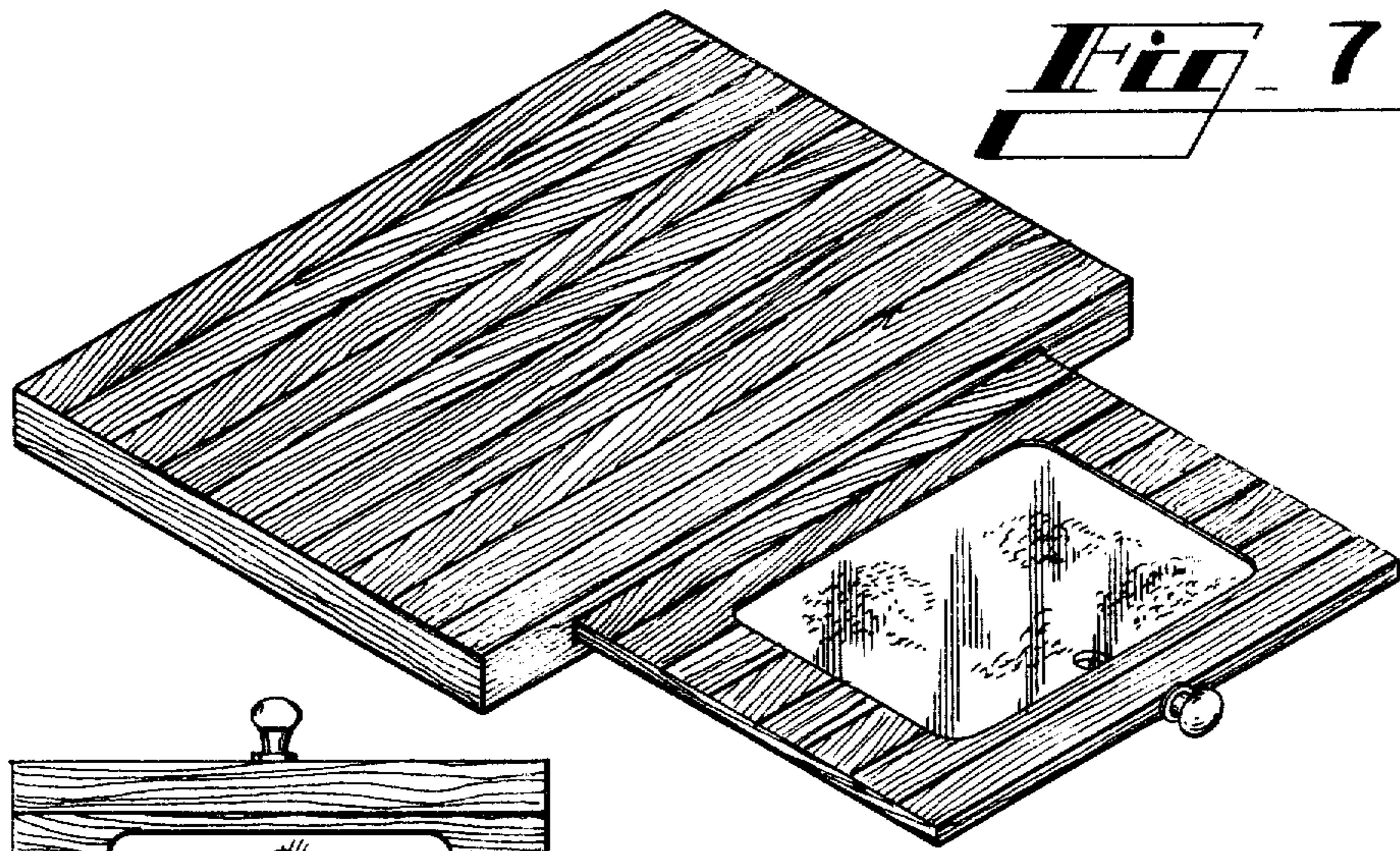

Fig. 8

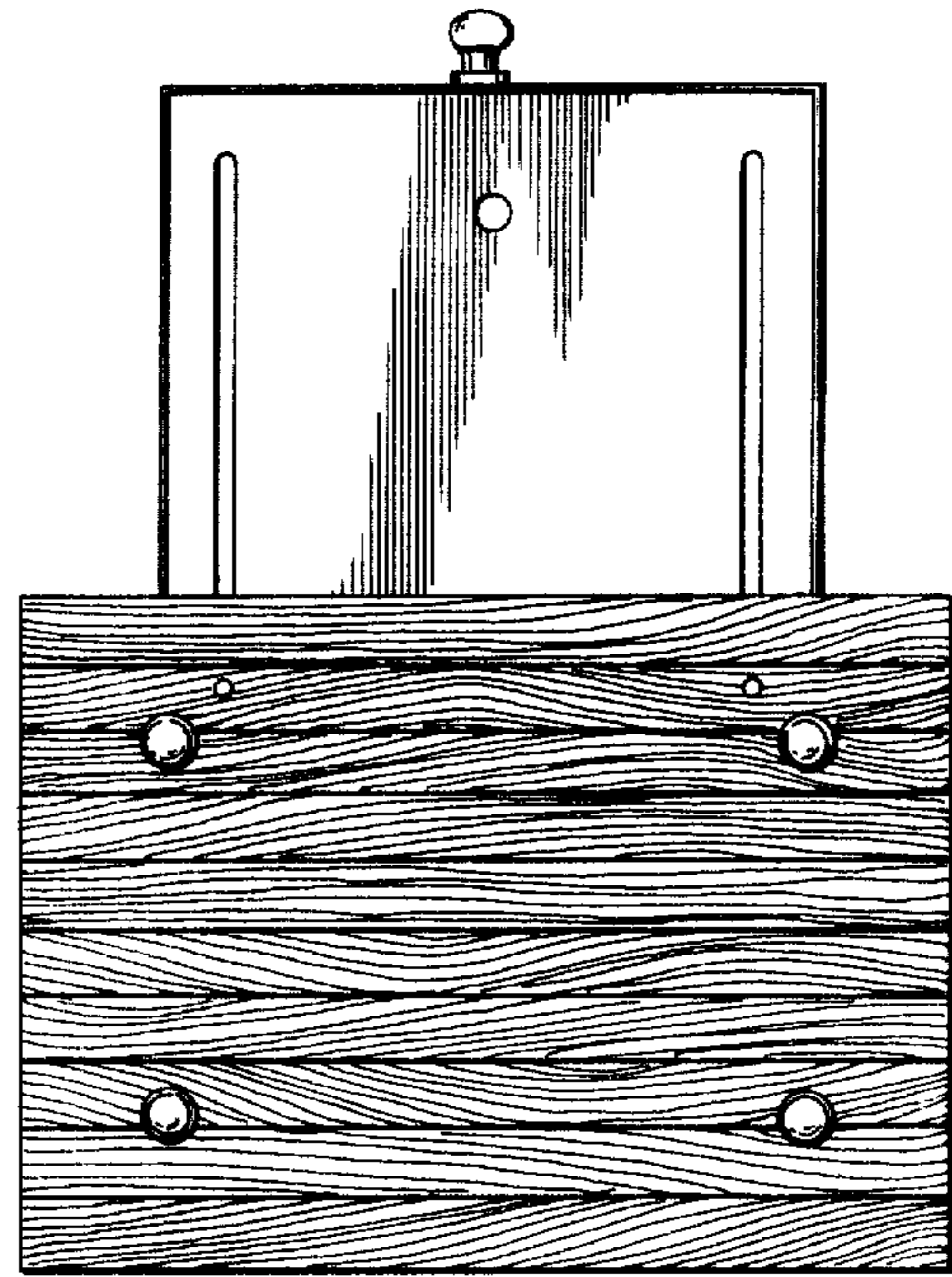

Fig. 9



Fig. 10