

[54] FACSIMILE ELECTROSTATIC COPIER

[75] Inventor: Nobuo Masaki, Tokyo, Japan

[73] Assignee: Canon Kabushiki Kaisha, Tokyo, Japan

[**] Term: 14 Years

[21] Appl. No.: 145,006

[22] Filed: Apr. 29, 1980

[30] Foreign Application Priority Data

Nov. 1, 1979 [JP] Japan 54-46326

[51] Int. Cl. D16-03

[52] U.S. Cl. D16/31

[58] Field of Search D16/27-32; 355/3 R

[56] References Cited

U.S. PATENT DOCUMENTS

- D. 236,915 9/1975 Hideshima D16/31
- D. 251,912 5/1979 Nakade D16/31
- D. 257,984 1/1981 Kurozumi et al. D16/31

Primary Examiner—Leland A. Sebastian
Attorney, Agent, or Firm—Fitzpatrick, Cella, Harper & Scinto

[57] CLAIM

The ornamental design for a facsimile electrostatic copier, as shown and described.

DESCRIPTION

FIG. 1 is a front elevational view of a facsimile electrostatic copier showing my new design;
 FIG. 2 is a rear elevational view thereof;
 FIG. 3 is a top plan view thereof;
 FIG. 4 is a bottom plan view thereof;
 FIG. 5 is a left side elevational view thereof;
 FIG. 6 is a right side elevational view; and
 FIG. 7 is a front perspective view thereof.

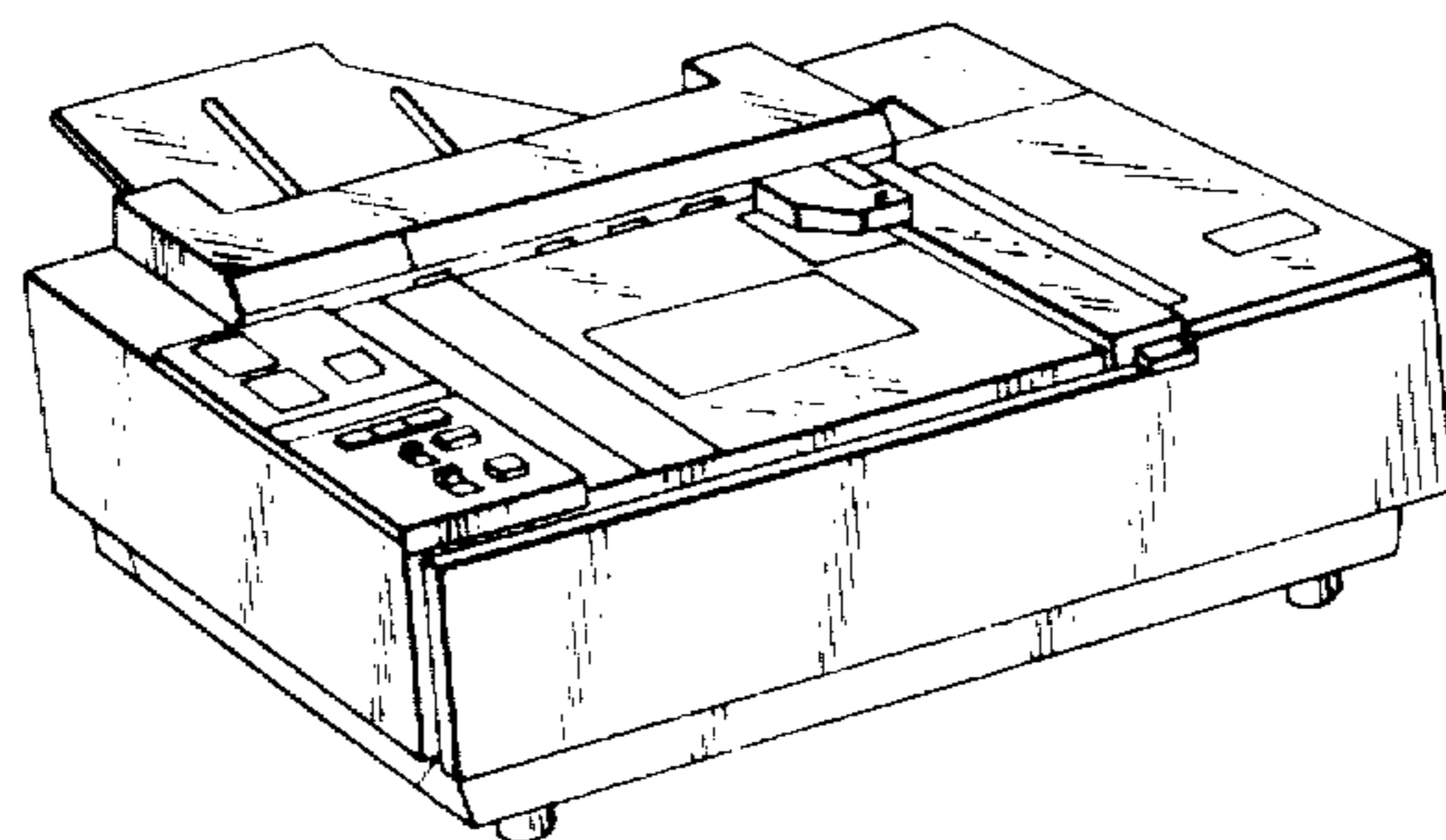

FIG. 1

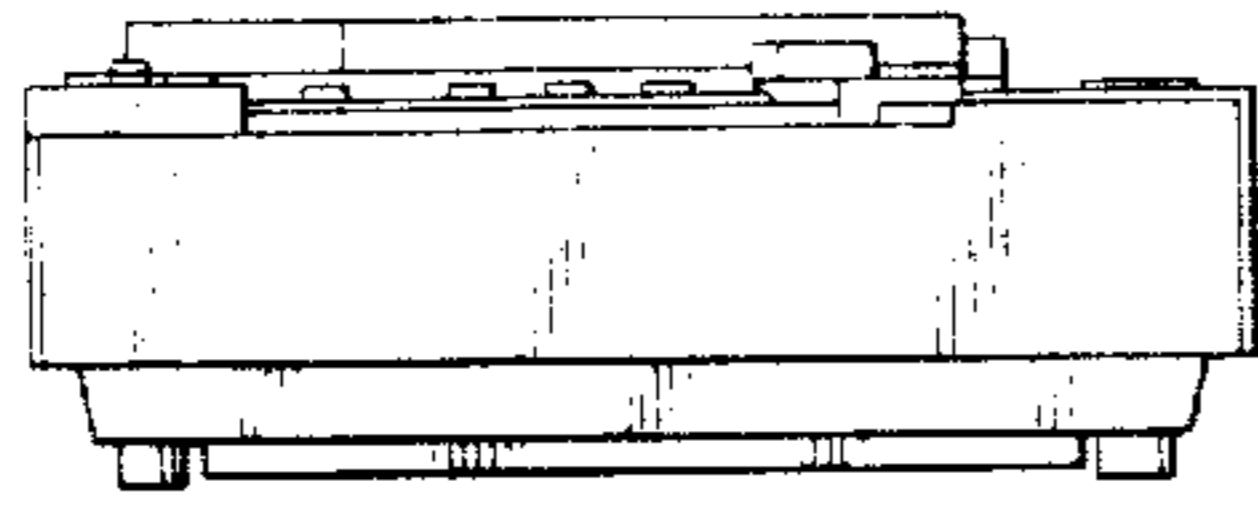

FIG. 2

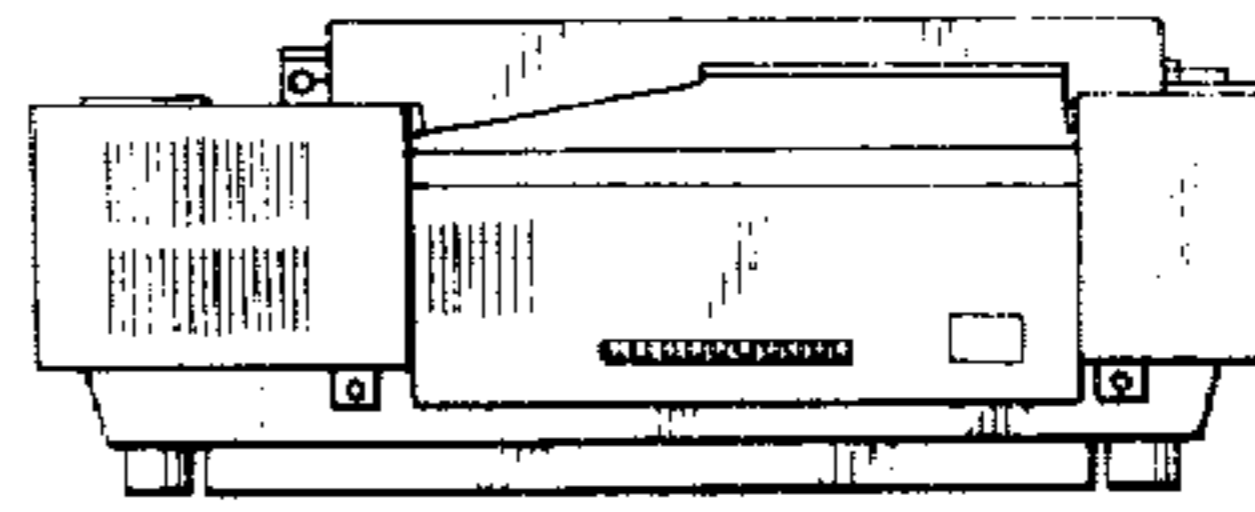

FIG. 3

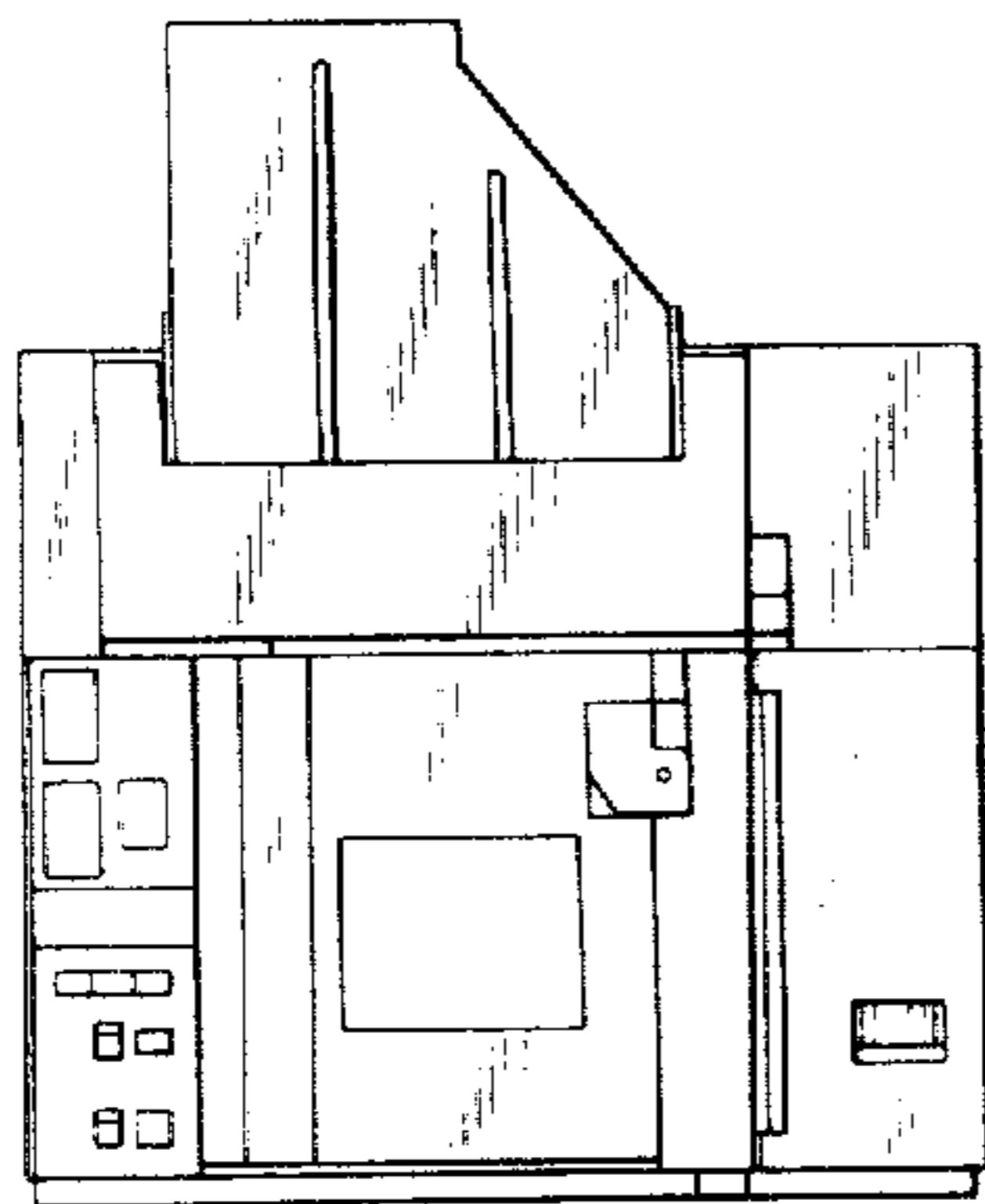

FIG. 4

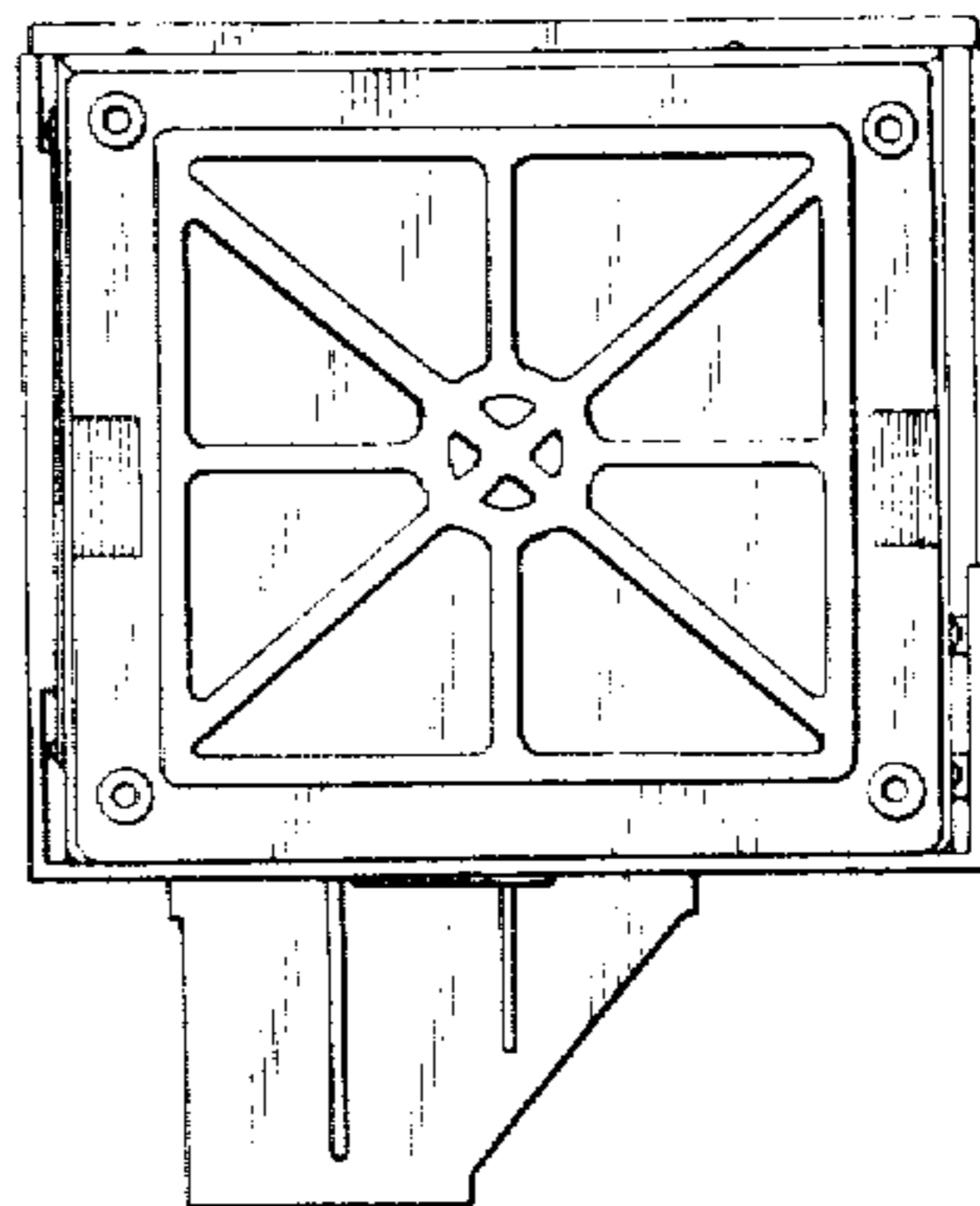

FIG. 5

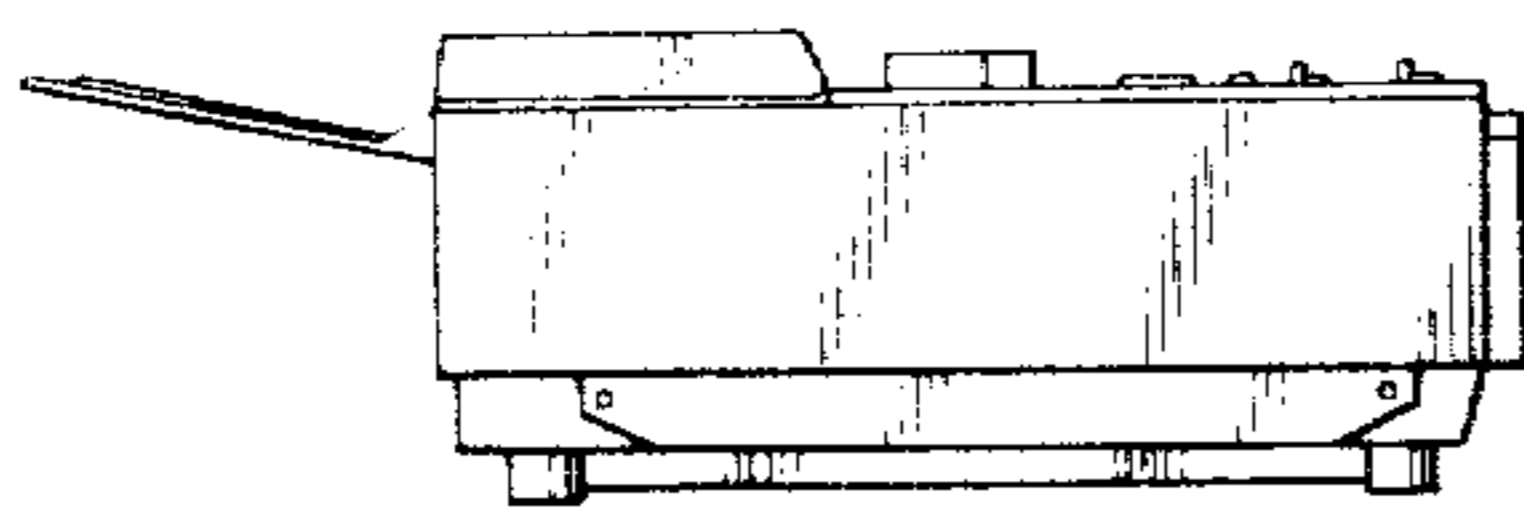

FIG. 6

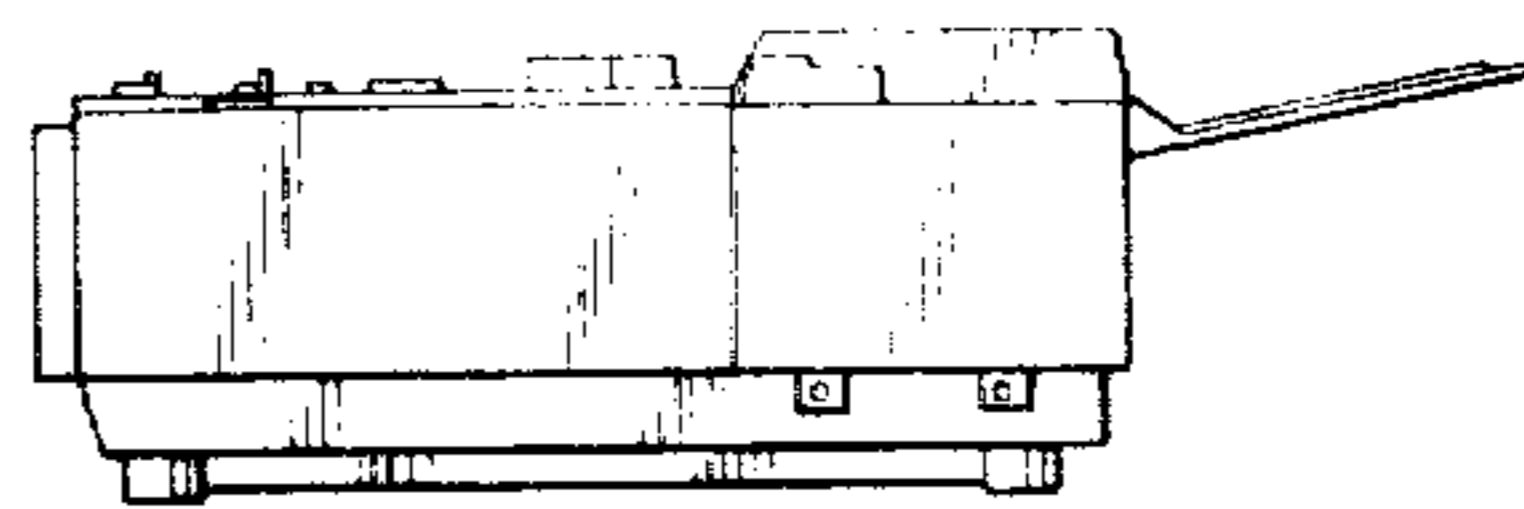

FIG. 7

