

[54] COFFEE MAKER

[75] Inventors: **Thomas E. Hanson**, Phoenixville, Pa.; **William L. Wolfe, deceased**, late of Pompey, N.Y., by **Ellen M. Wolfe**, administratrix

[73] Assignee: **SCM Corporation**, New York, N.Y.

[**] Term: **14 Years**

[21] Appl. No.: **196,906**

[22] Filed: **Oct. 14, 1980**

[51] Int. Cl. **D07-02**

[52] U.S. Cl. **D7/41; D15/113**

[58] Field of Search **D15/113; D7/62, 63, D7/41**

[56] **References Cited**

U.S. PATENT DOCUMENTS

D. 243,141	1/1977	Mantelet	D7/41
D. 248,720	8/1978	Sato et al.	D15/113 X
D. 250,688	1/1979	Felske et al.	D15/113 X
3,759,161	9/1973	Anderson	D7/62 X
4,069,750	1/1978	Kemp	D15/113 X

Primary Examiner—Winifred E. Herrmann
Attorney, Agent, or Firm—William E. Mear, III; Ernest F. Weinberger

[57] **CLAIM**

The ornamental design for a coffee maker, as shown.

DESCRIPTION

FIG. 1 is a front perspective view of a coffee maker showing our new design;
FIG. 2 is a front elevational view thereof;
FIG. 3 is a top plan view thereof;
FIG. 4 is a bottom plan view thereof;
FIG. 5 is a right side elevational view thereof;
FIG. 6 is a rear elevational view thereof; and
FIG. 7 is a left side elevational view thereof.

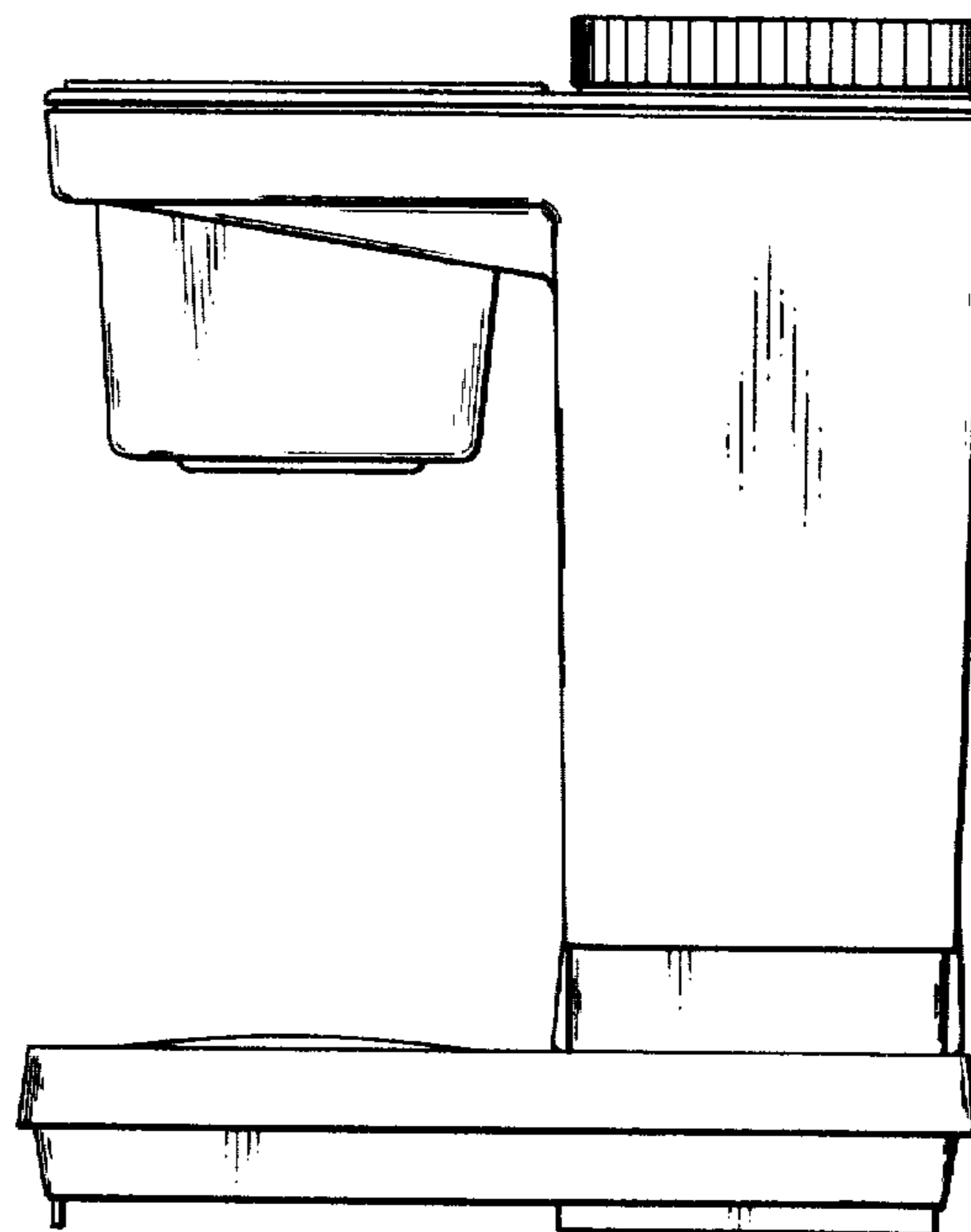
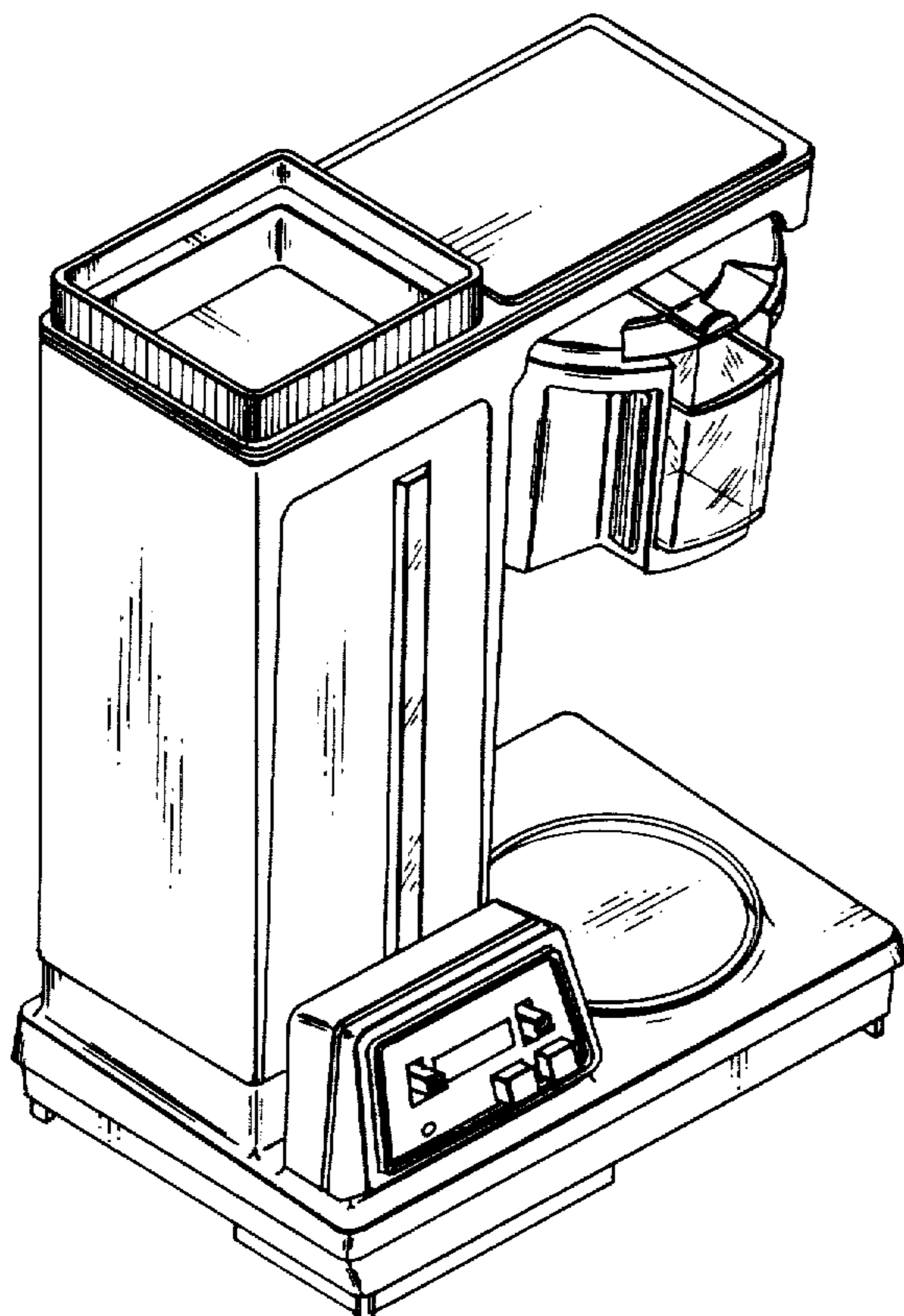

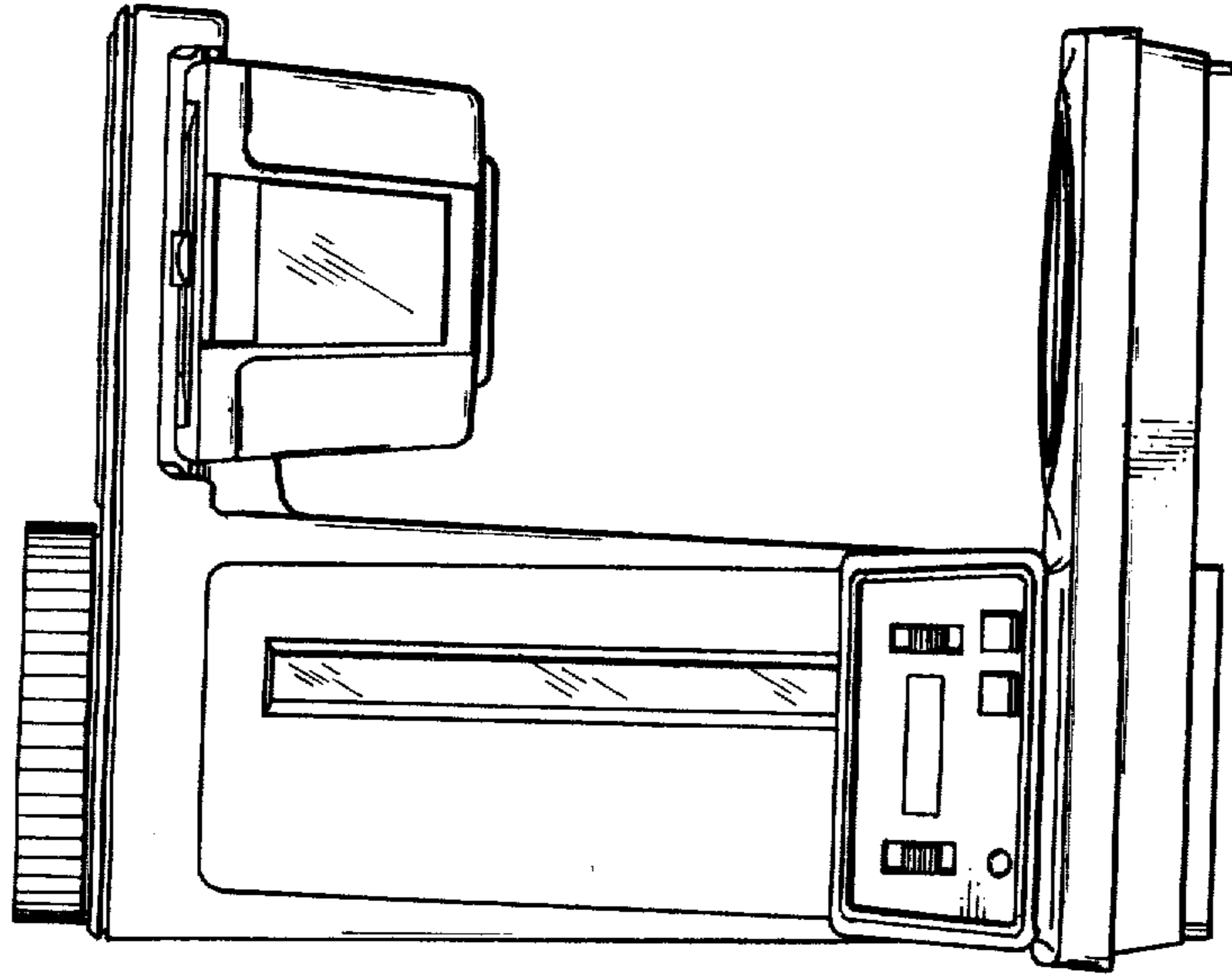

2-575

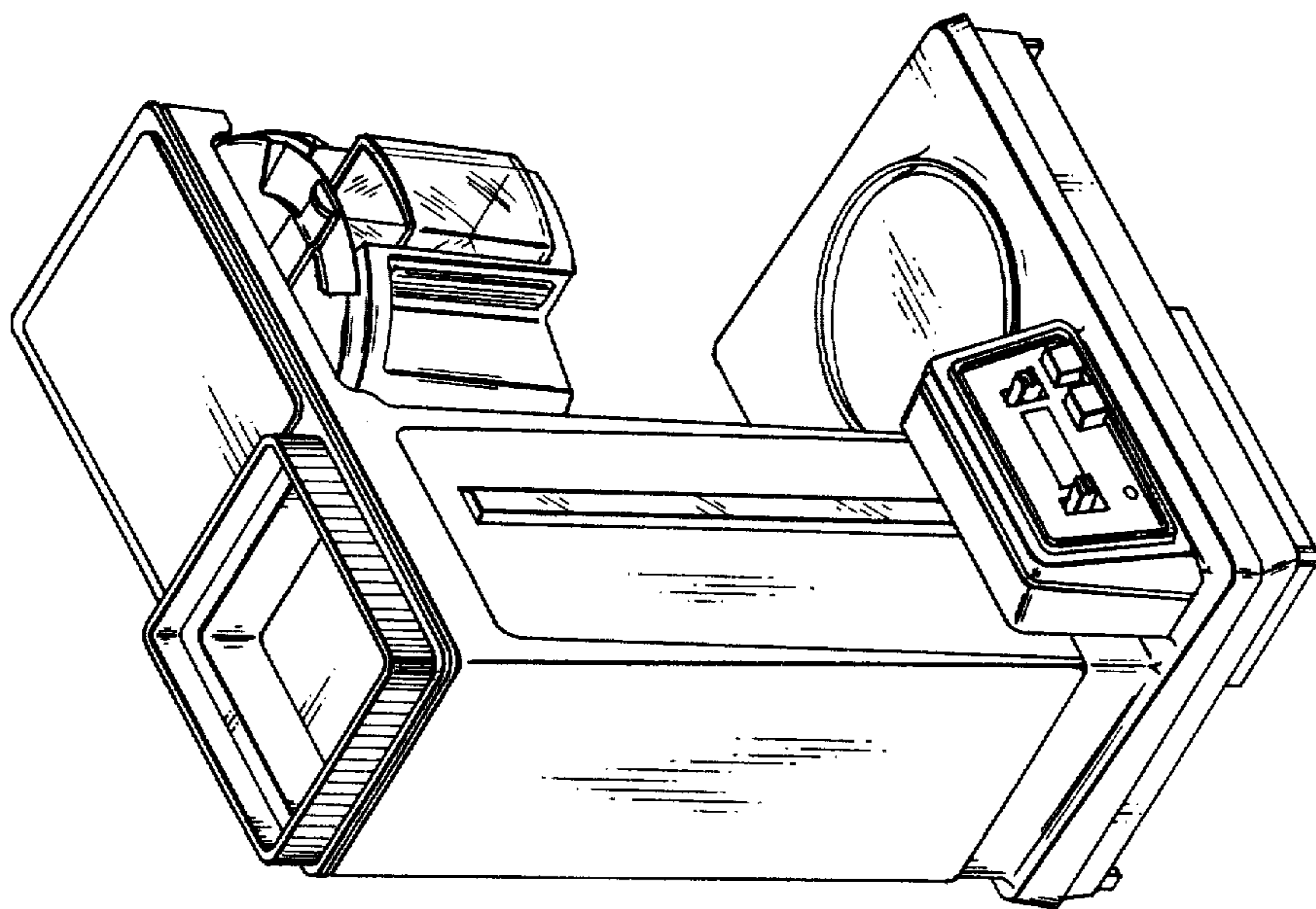

1-575

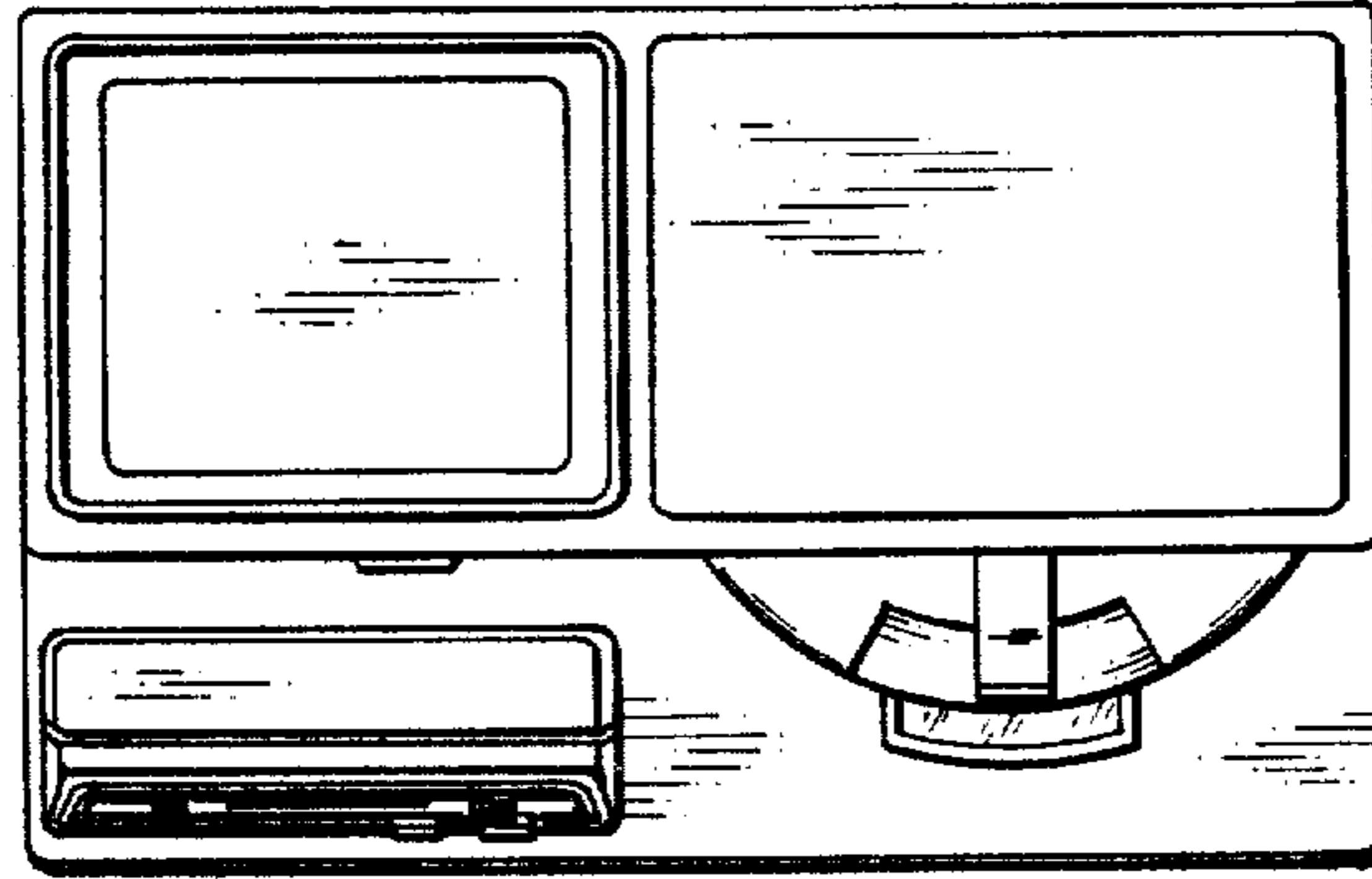

FIG 3

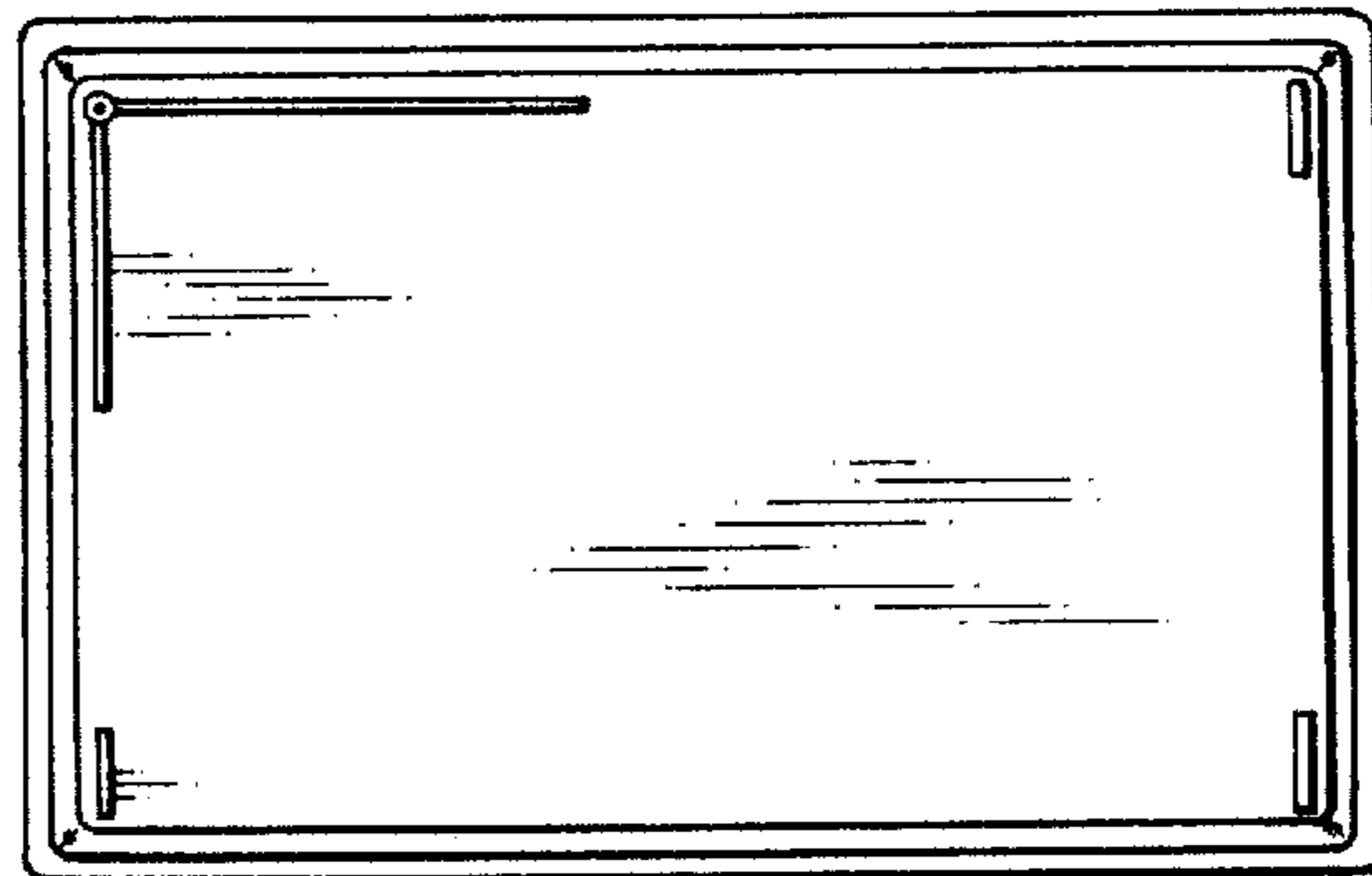
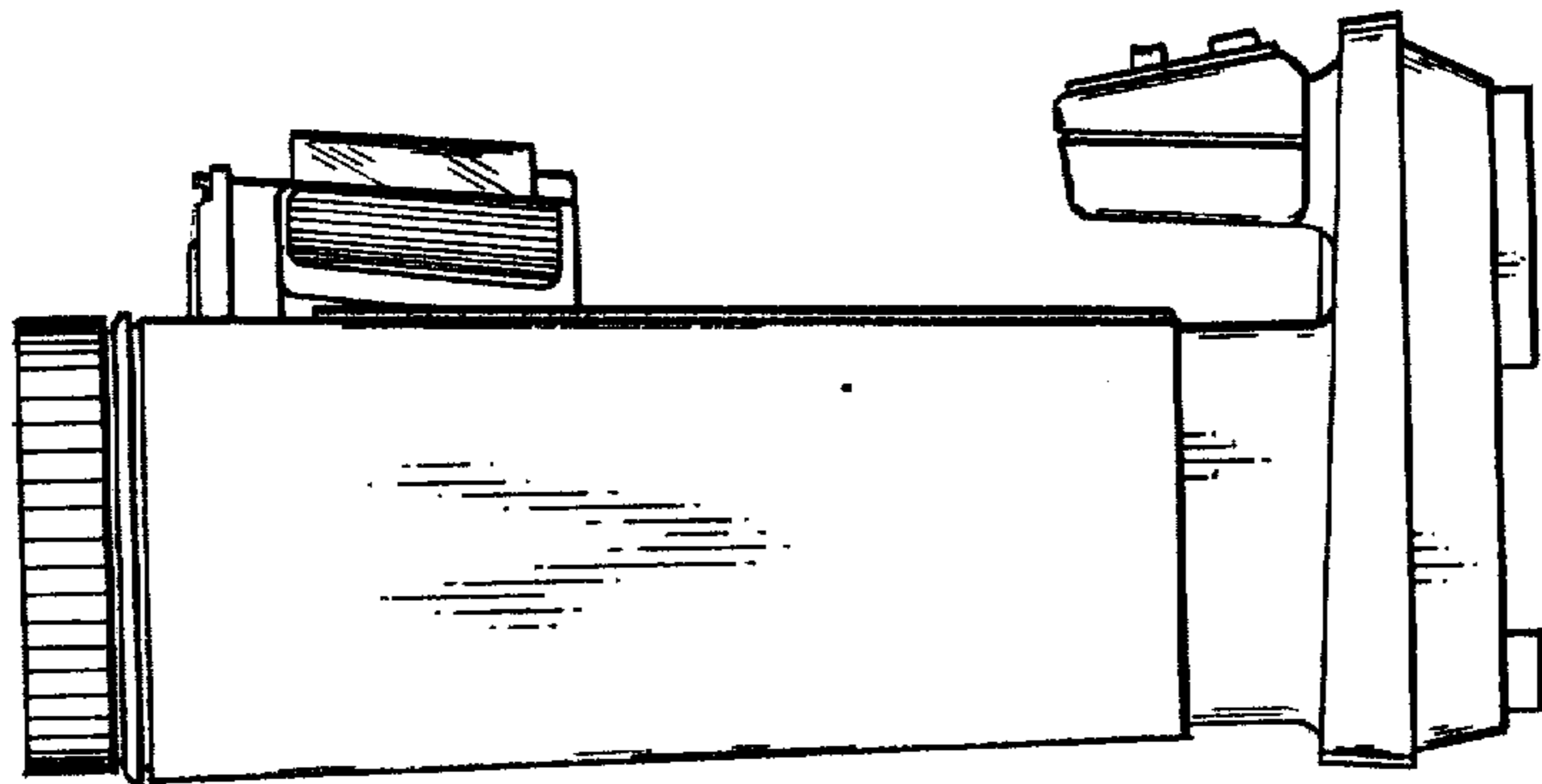
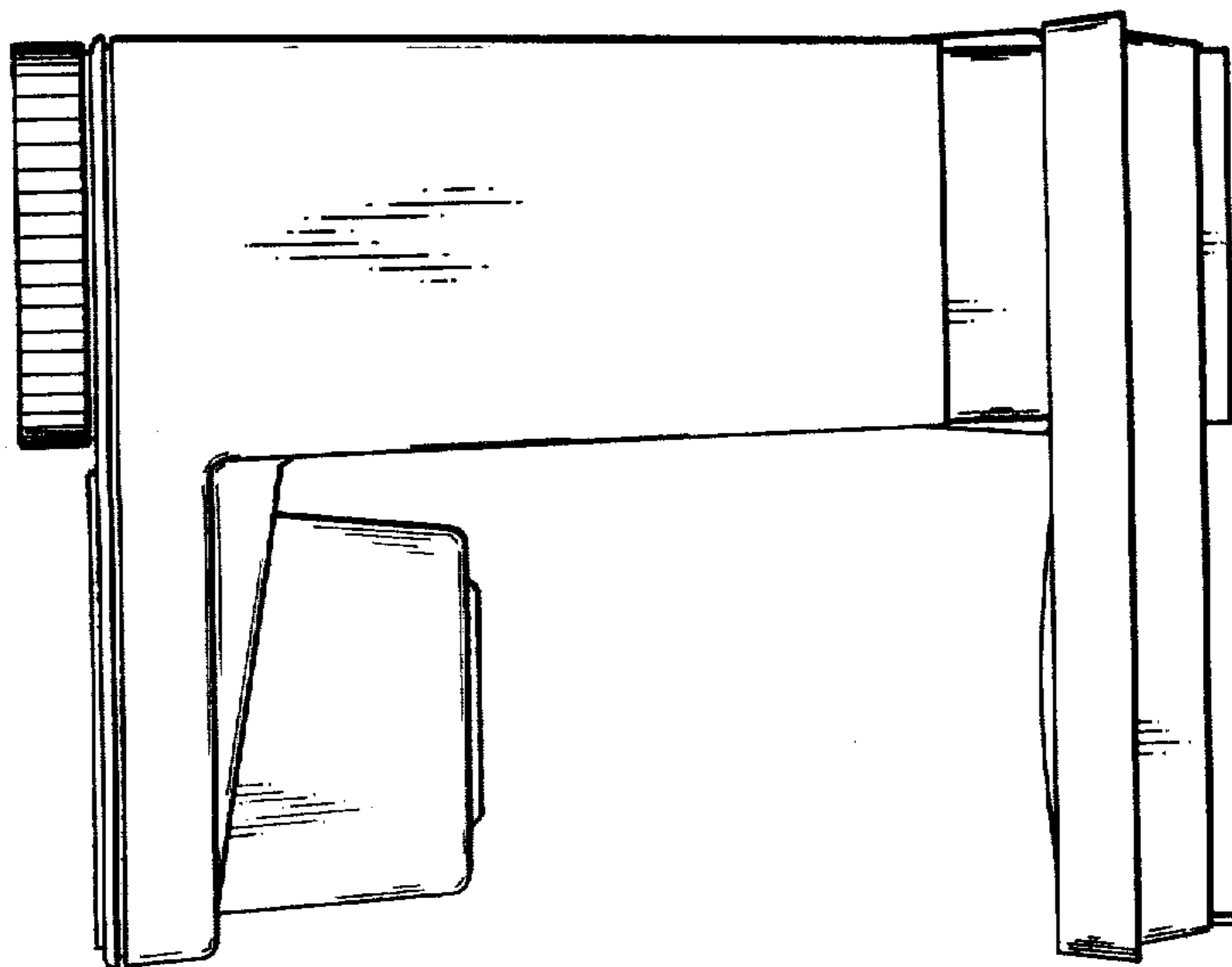

FIG 4



7



8

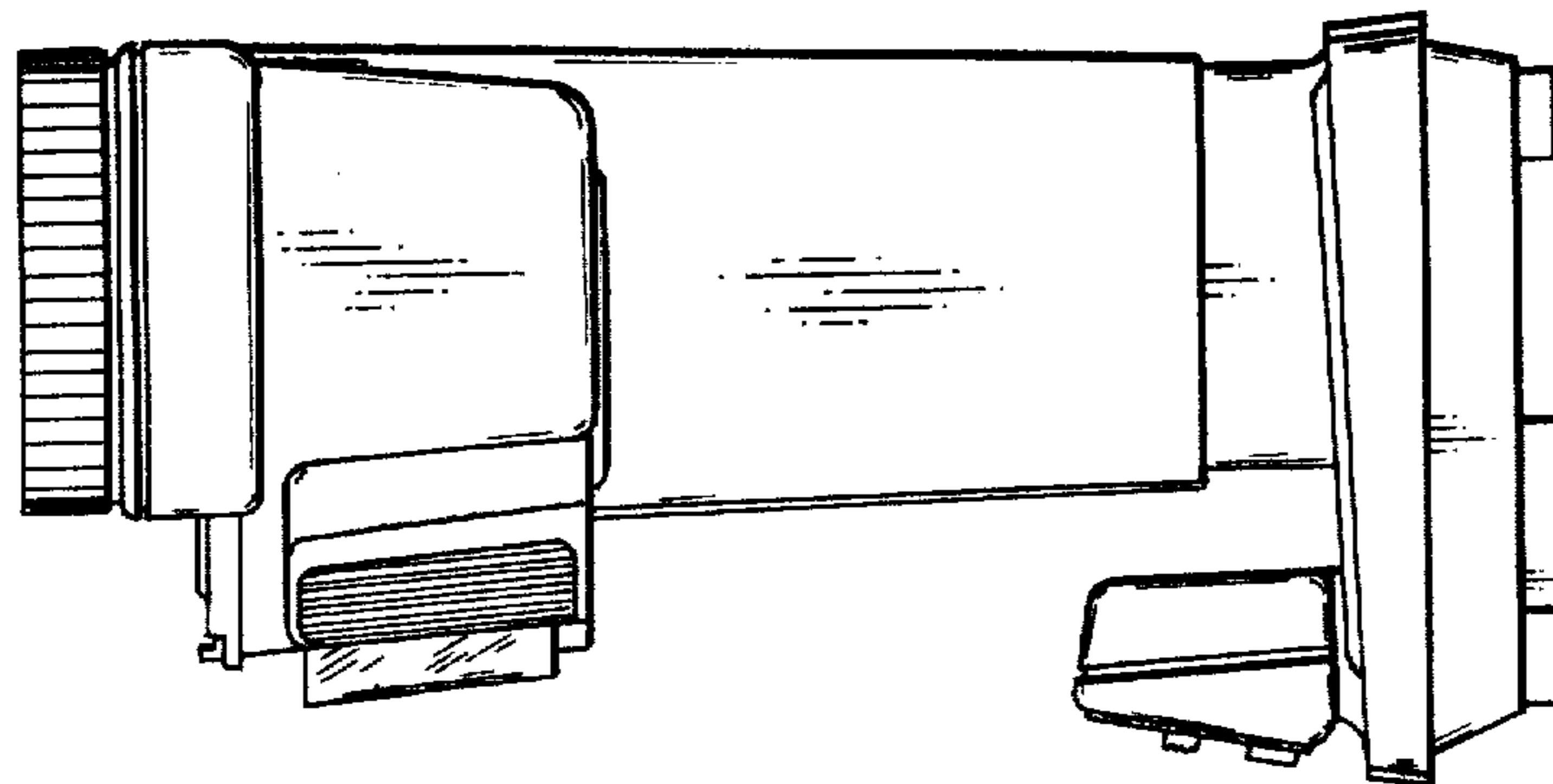

9